

BAYLINER[®]

2452 Classic Cruiser

Owner's Manual *Supplement*

Engine Serial Number: _____

Hull Identification Number: _____

Hull Identification Number

- The Hull Identification Number (HIN) is located on the starboard side of the transom.
- Record the HIN (and the engine serial numbers) in the space provided above.
- Include the HIN with any correspondence or orders.

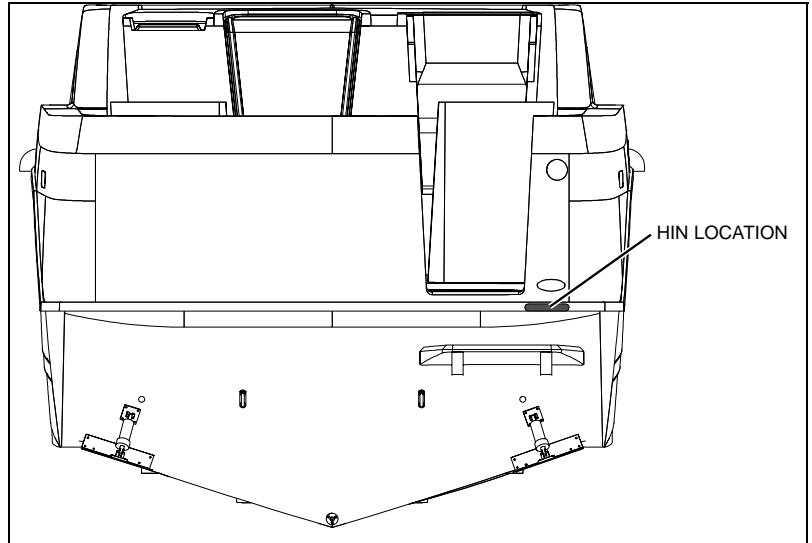

© 2003 Bayliner Technical Publications. All rights reserved.

No part of this publication may be reproduced, stored in any retrieval system, or transmitted in any form by any means, electronic, mechanical, photocopying, recording or otherwise, without prior written permission of Bayliner.

Printed in the United States of America.

General Notes

The material in this document is for information only and is subject to change without notice. While reasonable efforts have been made in the preparation of this document to assure its accuracy, Bayliner assumes no liability resulting from errors or omissions in this document, or from the use of information contained herein.

Due to our commitment to product improvement, Bayliner reserves the right to make changes in the product design, specifications, and equipment at any time without notice or obligation. Illustrations and/or photos may show optional equipment.

All Bayliner products meet or exceed USCG (United States Coast Guard) and/or NMMA (National Marine Manufacturer's Association) construction standards. Manufactured with 1,1,1 Trichloroethane, a substance which harms public health and environment during the manufacturing process by destroying ozone in the upper atmosphere.

Proprietary Rights

This document discloses subject matter in which Bayliner has proprietary rights. The information and design disclosed herein were originated by and are the property of Bayliner. Neither receipt nor possession thereof confers or transfers any right to reproduce, copy, alter or disclose the document or any part thereof, any information contained therein, or to construct boats or any item from it, except by written permission from or written agreement with Bayliner. This document is to be returned upon request to Bayliner.

CONTENTS

1 Chapter 1: Welcome Aboard!

- 1 Dimensions and Tank Capacities
- 1 Layout View
- 1 Dealer Service
- 1 Warranty Information
- 2 Boating Experience
- 2 Engine & Accessories Guidelines
- 2 Engine & Accessories Literature
- 2 Structural Limitations
- 3 Safety Standards
- 3 Qualified Maintenance
- 4 Special Care For Moored Boats
- 4 Sacrificial Anodes (Zincs)
- 5 Carbon Monoxide (CO)
 - 5 *Facts about CO*
 - 6 *Where and How CO Can Accumulate*
 - 6 *How to Protect Yourself and Others From CO*
 - 7 *Trip Checklist*
 - 7 *Monthly Checklist*
 - 7 *Annual Checklist*
 - 7 *Carbon Monoxide Alarm System*
 - 8 *More Information*

9 Chapter 2: Locations

- 9 Exterior Views
 - 9 *Hull Views*
 - 10 *Deck View*
 - 11 *Helm*
- 12 Component Locations

13 Chapter 3: Propulsion & Related Systems

- 13 Engine
- 13 Engine Room Ventilation System
- 14 Fuel System
 - 15 *Fuel Fill and Vent*
 - 15 *Fuel Filters*
 - 15 *Anti-siphon Valve*
- 16 Quick Oil Drain System

17 Chapter 4: Controls

- 17 Steering
- 17 Shift/Throttle
- 17 Power Trim and Tilt
- 18 Trim Tabs (If Equipped)

19 Chapter 5: Navigation & Communication Equipment

- 19 VHF Radio (If Equipped)
- 19 Compass (If Equipped)

20 Chapter 6: Plumbing

- 20 Bilge Pumps
 - 22 *Autofloat Switches*
- 23 Seawater Systems
 - 23 *Seacocks*
 - 23 *Seawater Strainers*
- 24 Freshwater System
 - 25 *Freshwater System Winterization*
 - 25 *Transom Shower (If Equipped)*
 - 26 *Water Heater*
 - 26 *Winterizing the Water Heater*
- 27 Drain Systems
 - 27 *Sink Drains*
 - 27 *Deck Drains*
- 28 Portable Toilet (If Equipped)
- 28 Marine Head with Holding Tank (If Equipped)
 - 28 *Winterizing The Marine Head*
 - 29 *Macerator (If Equipped)*

30	Chapter 7: Deck Equipment	36	Chapter 12: Electrical System
30	Cleats and Tow Eyes	37	12-Volt DC System
		37	<i>Batteries</i>
		37	<i>Fuses and Circuit Breakers</i>
		37	<i>Battery Switch</i>
		37	<i>Battery Switch Positions</i>
		38	<i>Alternator</i>
		38	<i>Battery Charger (If Equipped)</i>
		38	<i>12-Volt Accessory Outlet</i>
31	Chapter 8: Appliances & Entertainment Systems	39	120-Volt AC System (If Equipped)
31	Refrigerator (If Equipped)	40	<i>Shore Power</i>
31	Microwave Oven (If Equipped)	42	<i>Connecting To Shore Power</i>
31	Electric Stove (If Equipped)	43	<i>Transfer Switch (If Equipped with Dual Shore Power)</i>
32	Alcohol/Electric Stove (If Equipped)	44	Electrical Routings
32	Audio & Visual Equipment	44	<i>Hull Electrical Harness</i>
		44	<i>Deck Electrical Harness.</i>
33	Chapter 9: Convertible Seats, Beds, & Tables	45	<i>120 Volt AC System (If Equipped)</i>
33	Dinette/Berth	45	<i>Battery System</i>
		46	<i>Bonding Harness</i>
34	Chapter 10: Lights	47	Wire Diagrams
34	Care and Maintenance	47	<i>Engine Electrical System</i>
34	Navigation Lights	48	<i>Single Dockside</i>
34	Interior & Exterior Lights	49	<i>Dual Dockside</i>
35	Chapter 11: Air Conditioning (If Equipped)	50	Important Records
35	Air Conditioning System (If Equipped)	51	Float Plan

Hazard Boxes & Symbols

The hazard boxes and symbols shown below are used throughout this Supplement to call attention to potentially dangerous situations which could lead to either personal injury or product damage. **Read ALL warnings carefully and follow all safety instructions.**

 **DANGER!**
This box alerts you to immediate hazards which *WILL* cause severe personal injury or death if the warning is ignored.

 **WARNING!**
This box alerts you to hazards or unsafe practices which *COULD* result in severe personal injury or death if the warning is ignored.

 **CAUTION!**
This box alerts you to hazards or unsafe practices which *COULD* result in minor personal injury or cause product or property damage if the warning is ignored.

NOTICE
This box calls attention to installation, operation or maintenance information, which is important to proper operation but is not hazard related.

 FIRE HAZARD!	 EXPLOSION HAZARD!	 NO OPEN FLAME!	 ELECTRICAL HAZARD!	 HOT HAZARD!
---	--	---	--	--

 FALLING HAZARD!	 ROTATING PROPELLER HAZARD!	 RUN BILGE BLOWERS FOR 4 MINUTES!
--	---	--

DANGER
CARBON MONOXIDE
CO POISONING HAZARD!

Chapter 1: Welcome Aboard!

This *Owner's Manual Supplement* provides specific information about your boat that is not covered in the *Cruiser & Yacht Owner's Manual*. Please study the *Cruiser & Yacht Owner's Manual* and this *Supplement* carefully. Keep the *Cruiser & Yacht Owner's Manual* and this *Supplement* on your boat in a secure, yet readily available place.

Dimensions and Tank Capacities

Overall Length	Bridge Clearance	Beam	Draft (Drive Up)	Draft (Drive Down)	Fuel Capacity (gal.)	Freshwater Capacity (gal.)	Waste Holding Tank Capacity (gal.)
23' 9"	8' 9.5"	8' 6"	1'8. 5"	3' 5"	80	20	20

Layout View

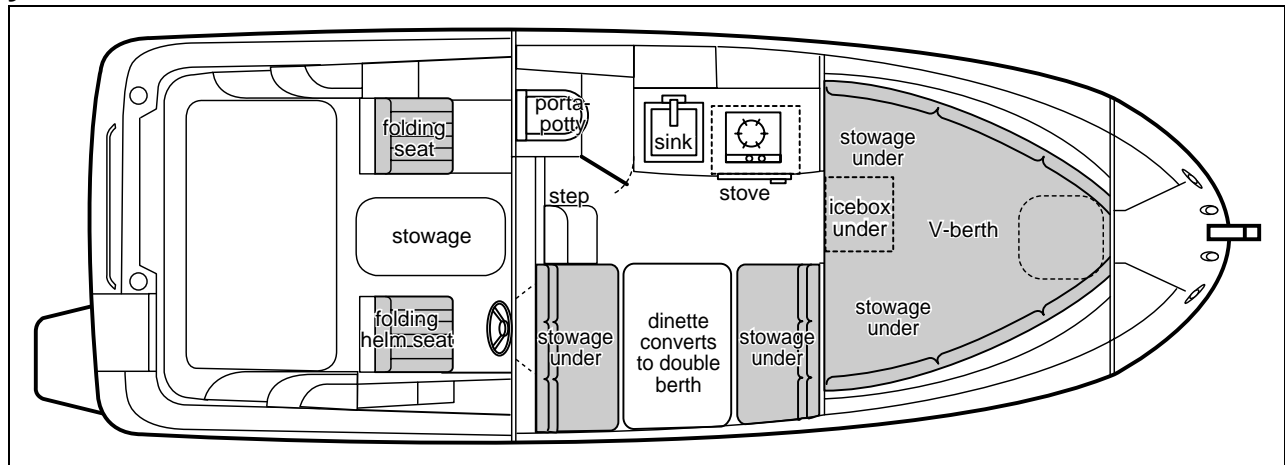

Dealer Service

- Ask your dealer to explain *all* systems *before* taking delivery of your boat.
- Your dealer is your key to service.
- Contact your dealer if you have any problems with your new boat.
- If your dealer cannot help, call our customer service hotline: 360-435-8957 or send us a FAX: 360-403-4235.
- Buy replacement parts from any authorized Bayliner dealer.

Warranty Information

- Bayliner offers a Limited Warranty on each new Bayliner purchased through an authorized Bayliner dealer.
- A copy of the Limited Warranty was included in your owner's packet.
- If you did not receive a copy of the Limited Warranty, please contact your dealer or call 360-435-8957 for a copy.

Boating Experience

 WARNING!
CONTROL HAZARD!
A qualified operator <i>must</i> be in control of the boat at <i>all</i> times. <i>DO NOT</i> operate your boat while under the influence of alcohol or drugs.

If this is your first boat or if you are changing to a type of boat you are not familiar with, for your own comfort and safety, obtain handling and operating experience before assuming command of the boat.

Take one of the boating safety classes offered by the U.S. Power Squadrons or the U.S. Coast Guard Auxiliary. For more course information, including dates and locations of upcoming classes, contact the organizations directly:

- U.S. Power Squadrons: 1-888-FOR-USPS (1-888-367-8777) or on the Internet at: <http://www.usps.org>
- U.S. Coast Guard Auxiliary: 1-800-368-5647 or on the Internet at: <http://www.cgaux.org>

Outside the United States, your selling dealer, national sailing federation or local boat club can advise you of local sea schools or competent instructors.

Engine & Accessories Guidelines

NOTICE
When storing your boat please refer to your engine's operation and maintenance manuals.

- Your boat's engine and accessories were selected to provide optimum performance and service.
- Installing a different engine or other accessories may cause unwanted handling characteristics.
- Should you choose to install a different engine or to add accessories that *will* affect the boat's running trim, have an experienced marine technician perform a safety inspection and handling test before operating your boat again.

Certain modifications to your boat can result in cancellation of your warranty protection. *Always* check with your dealer *before* making any modifications to your boat.

Engine & Accessories Literature

- The engine and accessories installed on your boat come with their own operation and maintenance manuals.
- Read and understand these manuals *before* using the engine and accessories.
- Unless noted otherwise, *all* engine and accessory literature referred to in this *Supplement* is included in your owner's packet.

Structural Limitations

The transom platform and bow platform are designed to be lightweight for proper boat balance. The load limit for these platforms is 30 pounds per square foot, evenly distributed.

Safety Standards

⚠ DANGER!





FALLING and ROTATING PROPELLER HAZARD!

NEVER allow anyone to ride on parts of the boat *not* designed for such use.

- **Sitting on seat backs, lounging on the forward deck, bow riding, gunwale riding or occupying the transom platform while underway is especially hazardous and will cause personal injury or death.**

⚠ DANGER!





ROTATING PROPELLER and CARBON MONOXIDE POISONING HAZARD!

- **NEVER** allow anyone to occupy, or hang from, the back deck or swim platform while the engine(s) are running.
- **Teak surfing, dragging, or water skiing within 20 feet of a moving watercraft can be fatal.**

⚠ DANGER!

PERSONAL SAFETY HAZARD!

ALWAYS secure the anchor and other loose objects *before* getting underway. The anchor and other items that are *not* properly secured can come loose when the boat is moving and cause personal injury or death.

- Your boat's mechanical and electrical systems were designed to meet safety standards in effect at the time it was built.
- Some of these standards were mandated by law, *all* of them were designed to insure your safety, and the safety of other people, vessels and property.

In addition to this *Owner's Manual Supplement*, please read the *Cruiser & Yacht Owner's Manual* and *all* accessory instructions for important safety standards and hazard information.

Qualified Maintenance

⚠ WARNING!

To maintain the integrity and safety of your boat, allow only qualified personnel to perform maintenance on, or in any way modify: The steering system, propulsion system, engine control system, fuel system, environmental control system, electrical system or navigational system.

- Failure to maintain your boat's systems (listed in the warning above) as designed could violate the laws in your jurisdiction and could expose you and other people to the danger of bodily injury or accidental death.
- Follow the instructions provided in the *Cruiser & Yacht Owner's Manual*, this *Owner's Manual Supplement*, the engine owner's manual and *all* accessory instruction sheets and manuals.

Special Care For Moored Boats

NOTICE

- To help seal the hull bottom and reduce the possibility of gelcoat blistering on moored boats, apply an epoxy barrier coating. The barrier coating should be covered with several coats of anti-fouling paint.
- Many states regulate the chemical content of bottom paints in order to meet environmental standards. Check with your local dealer about recommended bottom paints, and about the laws in effect in your area.

- Whether moored in saltwater or freshwater, your boat *will* collect marine growth on its hull bottom.
- This will detract from the boat's beauty, greatly affect its performance and may damage the gelcoat.
- Periodically haul the boat out of the water and scrub the hull bottom with a bristle brush and a solution of soap and water.

Sacrificial Anodes (Zincs)

NOTICE

Do not paint between the zinc and the metal surface it contacts and do not paint over the zincs.

Your boat is equipped with sacrificial anodes (zincs) to protect underwater metal parts from excessive deterioration. Check the zincs regularly and replace them if they have deteriorated more than 70%.

There are many factors that affect the rate at which the zincs deteriorate, including:

- Water temperature
- Salinity
- Water pollution

Stray electrical current from the boat or dock may cause complete deterioration in just a few weeks. If there is rapid zinc deterioration, measure the electrolytic corrosion around your boat with a Corrosion Test Meter. If the zincs are *not* bonded correctly, they *will not* provide protection.

Carbon Monoxide (CO)

⚠ DANGER!	
	<ul style="list-style-type: none"> • Carbon monoxide gas (CO) is colorless, odorless, tasteless, and extremely dangerous. • All engines, generators, and fuel burning appliances produce CO as exhaust. • Prolonged exposure to low concentrations or very quick exposure to high concentrations <i>will</i> cause BRAIN DAMAGE or DEATH. • Teak surfing, dragging, or water skiing within 20 feet of a moving watercraft can be fatal.

Facts about CO

- CO poisoning causes a significant number of boating deaths each year.
- Called the "silent killer", CO is an extremely toxic, colorless, odorless and tasteless gas.
- CO can harm or even kill you inside or outside your boat.
- CO can affect you whether you're underway, moored, or anchored.
- CO symptoms are similar to seasickness or alcohol intoxication.
- CO can make you sick in seconds. In high enough concentrations, even a few breaths can be fatal.
- Breathing CO blocks the ability of your blood to carry oxygen.
- The effects are cumulative, even low levels of exposure can result in injury or death.

Factors That Increase the Effects of CO Poisoning

- Age
- Smokers or people exposed to high concentrations of cigarette smoke
- Consumption of alcohol
- Lung disorders
- Heart problems
- Pregnancy

Where and How CO Can Accumulate

Stationary Conditions That Increase CO Accumulations Include:

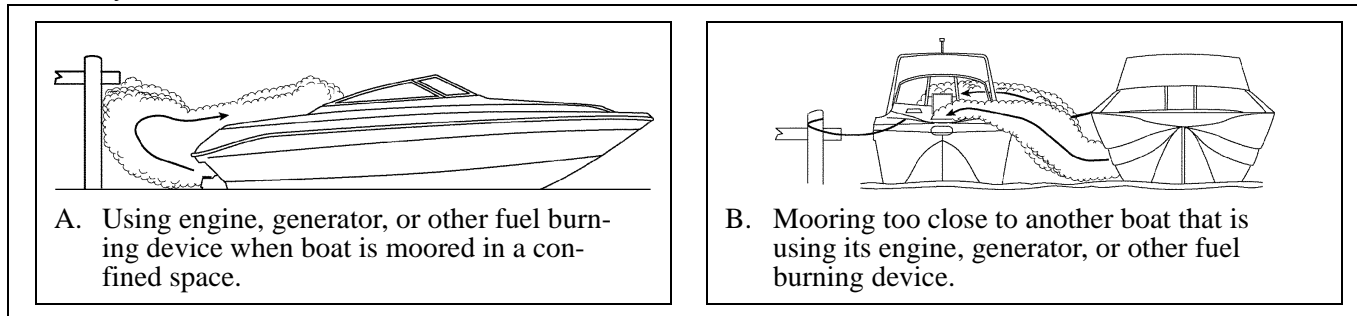

To correct stationary situations A and/or B:

- **Close all** windows, portlights and hatches.
- If possible, move your boat away from source of CO.

Running Conditions That Increase CO Accumulations Include:

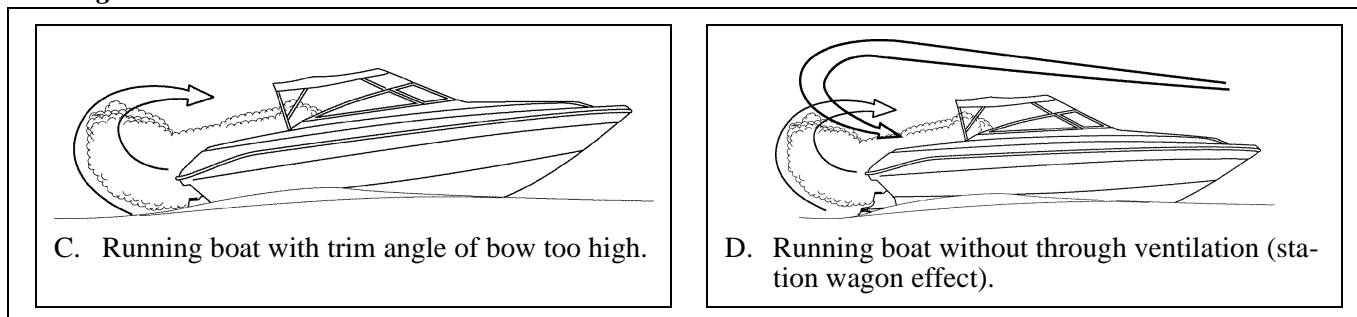

To correct running situations C and/or D:

- Trim bow down.
- **Open** windows and canvas.
- When possible, run boat so that prevailing winds help dissipate exhaust.

How to Protect Yourself and Others From CO

- Know where and how CO may accumulate in and around your boat (see above).
- Maintain fresh air circulation throughout the boat at **all** times.
- Know where your engine and generator exhaust outlets are located and keep everyone away from these areas.
- **Never** sit on, or hang onto, the back deck or swim platform while the engine(s) are running.
- **Never** enter the areas under swim platforms where exhaust outlets are located.
- Although CO can be present without the smell of exhaust fumes, if exhaust fumes are detected on the boat, take immediate action to dissipate these fumes.
- Treat symptoms of seasickness as possible CO poisoning. Get the person into fresh air immediately. Seek medical attention—unless you're sure it's **not** CO.
- Install and maintain CO alarms inside your boat. **Do not** ignore any alarm. Replace alarms as recommended by the alarm manufacturer.
- Follow the checklists provided on the next page.
- Get a Vessel Safety Check.

For information on how to get a free VESSEL SAFETY CHECK, visit www.vesselsafetycheck.org or contact your local U.S. Coast Guard Auxiliary or United States Power Squadrons®.

- U.S. Coast Guard Auxiliary: 1-800-368-5647 or on the Internet at: <http://www.cgaux.org>
- U.S. Power Squadrons: 1-888-FOR-USPS (1-888-367-8777) or on the Internet at: <http://www.usps.org>

Trip Checklist

- Make sure you know where the exhaust outlets are located on your boat.
- Educate *all* passengers about the symptoms of CO poisoning and where CO may accumulate.
- When docked, or rafted with another boat, be aware of exhaust emissions from the other boat.
- Confirm that water flows from the exhaust outlet when the engines and generator are started.
- Listen for any change in exhaust sound, which could indicate an exhaust component failure.
- Test the operation of each CO alarm by pressing the test button.

Monthly Checklist

- Make sure all exhaust clamps are in place and secure.
- Look for exhaust leaking from exhaust system components. Signs include rust and/or black streaking, water leaks, or corroded or cracked fittings.
- Inspect rubber exhaust hoses for burned, cracked, or deteriorated sections. All rubber hoses should be pliable and free of kinks.

Annual Checklist

Have a Qualified Marine Technician:

- Replace exhaust hoses if cracking, charring, or deterioration is found.
- Ensure that your engines and generators are properly tuned, and well maintained.
- Inspect each water pump impeller and the water pump housing. Replace if worn. Make sure cooling systems are in working condition.
- Inspect all metallic exhaust components for cracking, rusting, leaking, or loosening. Make sure they check the cylinder head gasket, exhaust manifold, water injection elbow, and the threaded adapter nipple between the manifold and the elbow.
- Clean, inspect, and confirm proper operation of the generator cooling water anti-siphon valve (if equipped).

Carbon Monoxide Alarm System

⚠ DANGER!



CARBON MONOXIDE POISONING HAZARD!

- The house battery switch *must* be in the *On* position for the CO Monitors to work.

NOTICE

The stereo memory and CO monitor(s) place a small, but constant drain on the battery. If your boat will be unattended for an extended amount of time, plug into shore power with the battery charger turned *On*, or disconnect the battery if shore power is *not* an option.

- Your boat features a carbon monoxide (CO) alarm system.
- ***Do not disconnect the alarm system.***
- Read and understand the manufacturer's instructions for your CO alarm system. If you did *not* receive an instruction manual, call (800) 383-0269 and one will be mailed to you.

If your boat is *not* equipped with a carbon monoxide alarm, consider purchasing one from your dealer or marine supply store.

More Information

For more information about how you can prevent carbon monoxide poisoning on recreational boats and other ways to boat more safely, contact:

United States Coast Guard

Office of Boating Safety (G-OPB-3)
2100 Second Street SW
Washington, DC 20593
www.uscgboating.org
1-800-368-5647

National Marine Manufacturers Association (NMMA)

200 East Randolph Drive
Suite 5100
Chicago, IL 60601-9301
www.nmma.org
312-946-6200

American Boat & Yacht Council, Inc. (ABYC)

3069 Solomon's Island Road
Edgewater, MD 21037-1416
www.abycinc.org
410-956-1050

For information on how to get a free VESSEL SAFETY CHECK, visit www.vesselsafetycheck.org or contact your local U.S. Coast Guard Auxiliary or United States Power Squadrons®.

- U.S. Coast Guard Auxiliary: 1-800-368-5647 or on the Internet at: <http://www.cgaux.org>
- U.S. Power Squadrons: 1-888-FOR-USPS (1-888-367-8777) or on the Internet at: <http://www.usps.org>

Chapter 2: Locations

Exterior Views

Hull Views

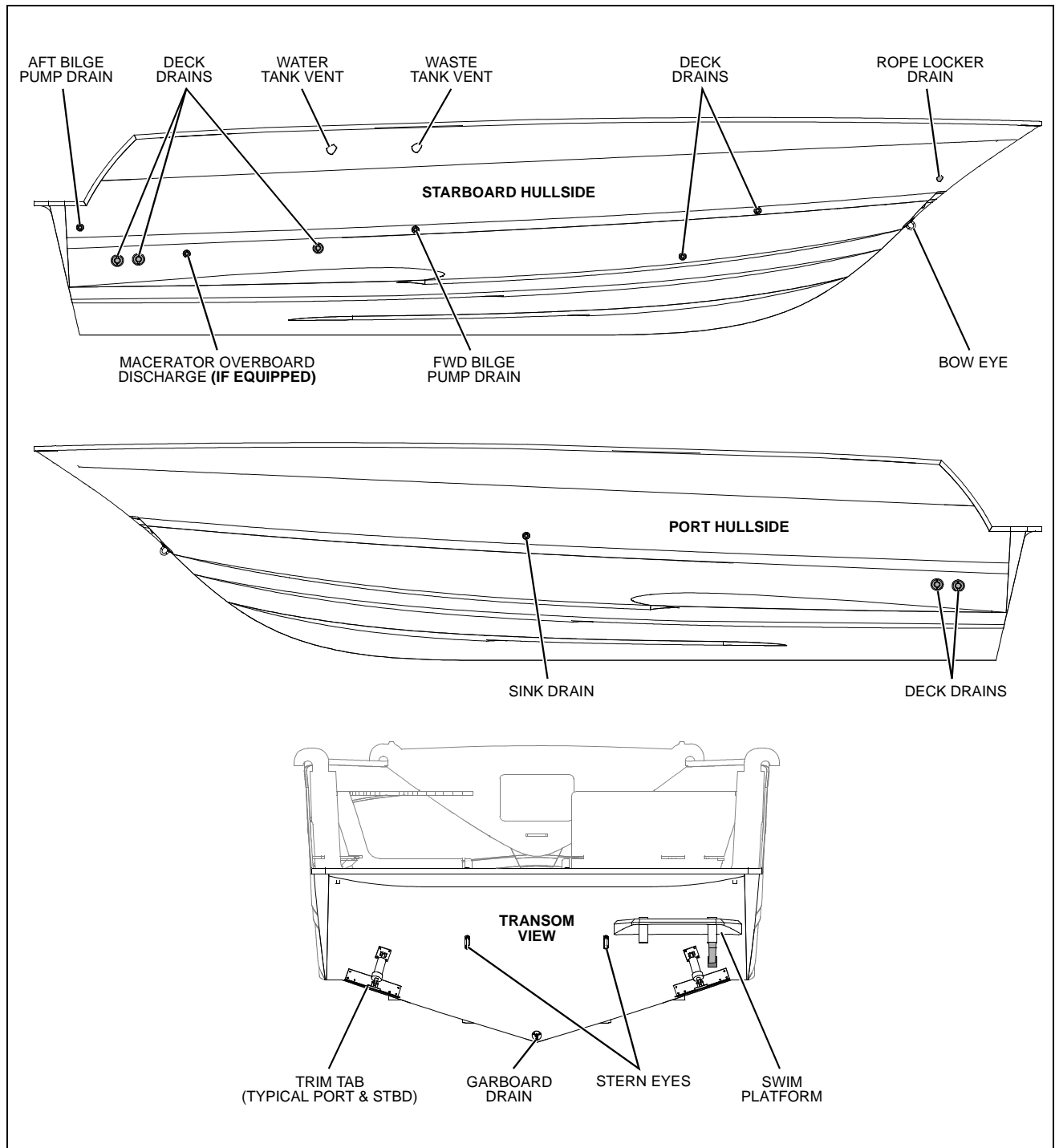

Deck View

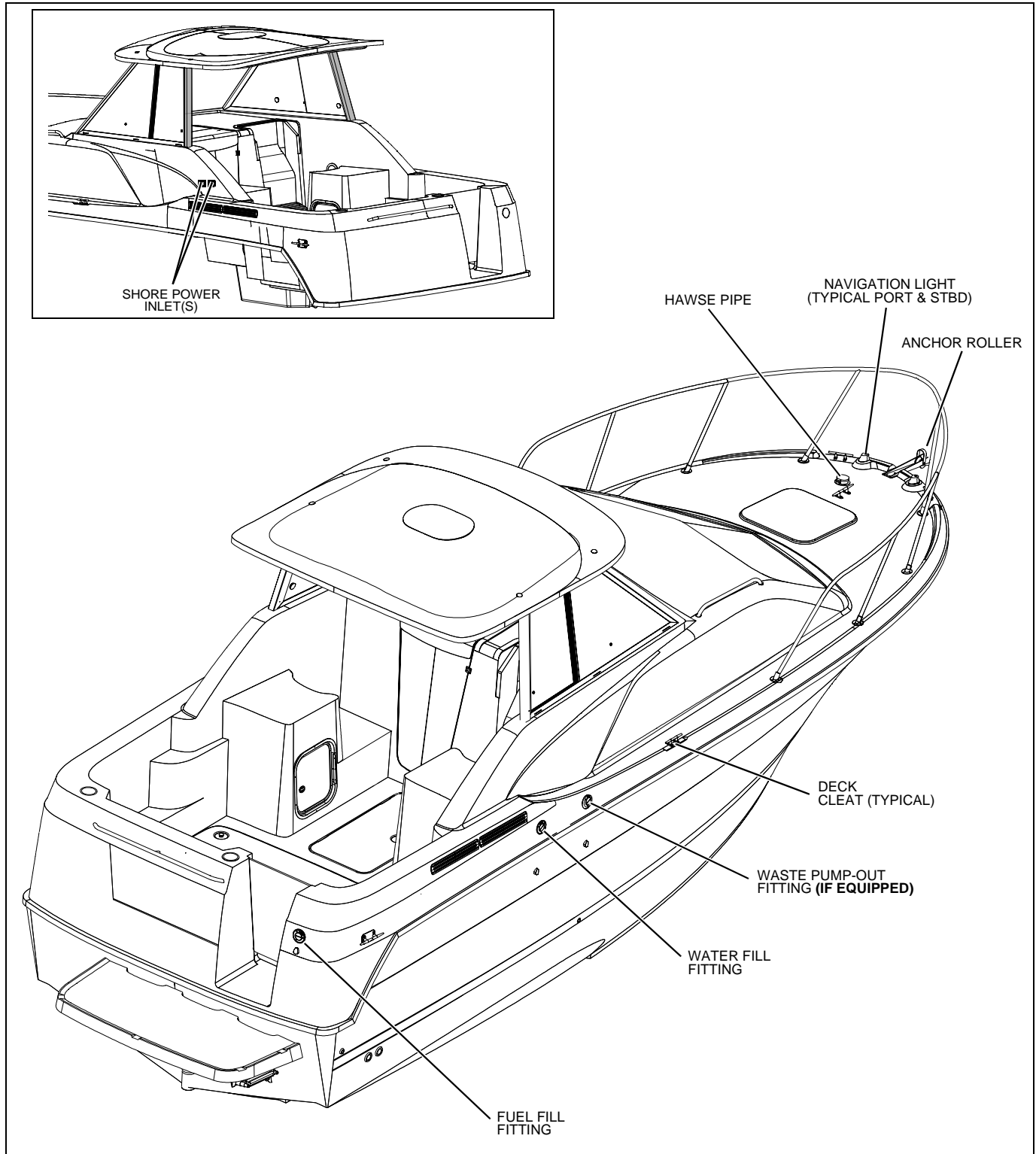

Helm

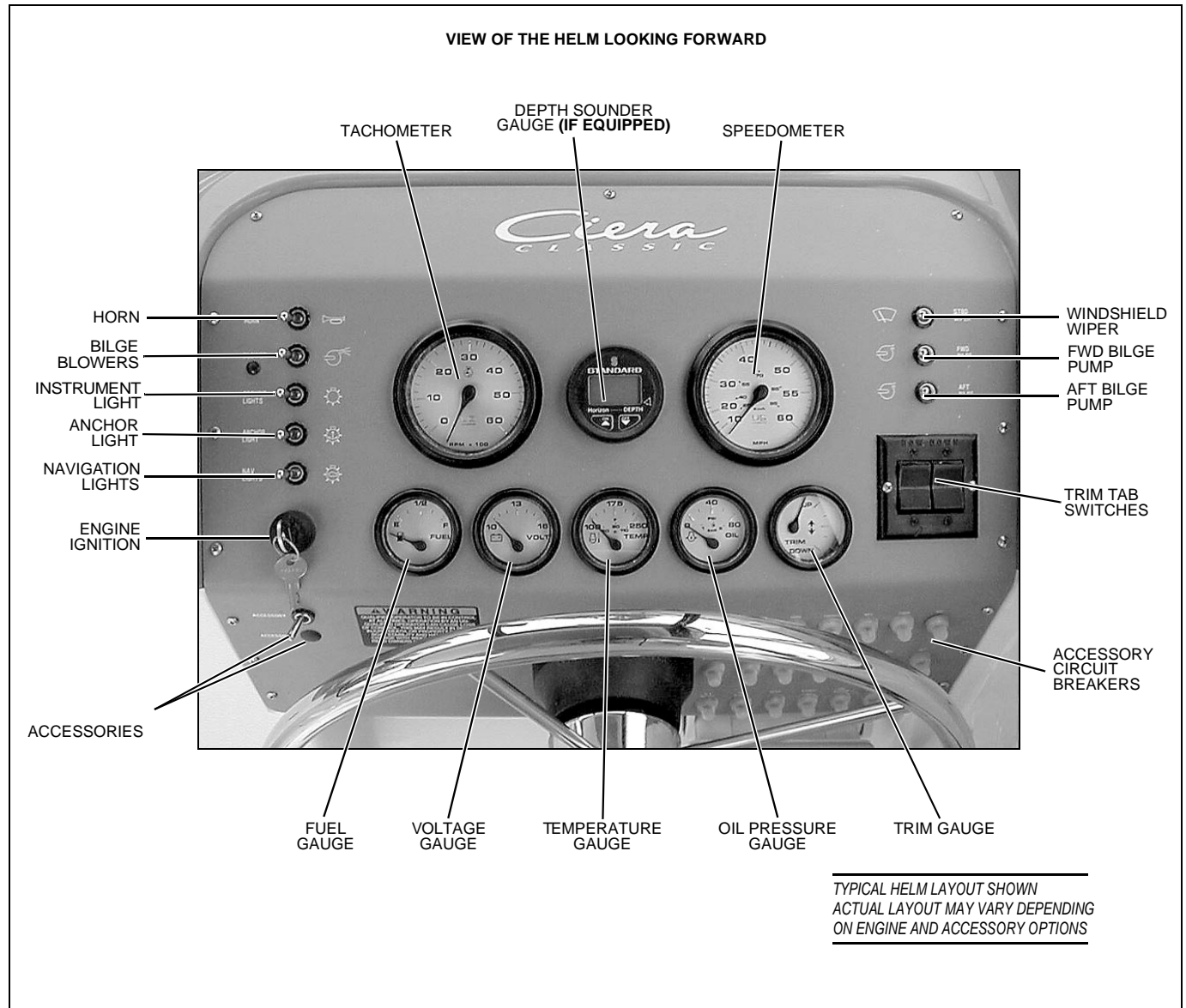

Component Locations

12-Volt Accessory Outlet: At the helm on the dash panel.

Air Conditioner Seawater Intake Seacock: Under the cabin entry step.

Air Conditioner Unit: In the V-berth. Access is through the starboard aft V-berth hatch.

Battery: On the starboard side of the engine room, aft of the battery charger.

Battery Charger: On the starboard side of the engine room.

Battery Switch: Inside the storage compartment, under the helm seat.

Bilge pump - Aft: In the engine compartment.

Bilge pump - Forward: Under cabin entry step.

Carbon Monoxide Detector: In the cabin on the starboard aft dinette wall.

DC Circuit Breakers: At the helm, under the dash.

Engine Circuit Breaker: On the engine.

Fuel Fill: On the starboard aft corner of the deck.

Fuel Tank: In the engine compartment forward of the engine.

Macerator Underwater Discharge Seacock: Inside the engine room.

Navigation Lights: Red and green lights at the bow. White all-around light on the hardtop.

Waste Holding Tank: Access is through the center floor hatch in the cockpit.

Water Fill: On the starboard side deck.

Water Heater: In the center floor hatch in the cockpit, to the left of the holding tank.

Water Pump: Inside the center floor hatch in the cockpit, next to the water/holding tanks.

Water Pump Switch: Inside the cabin, at the galley, to the left of the galley faucet.

Water Tank: Access is through center floor hatch in the cockpit.

Chapter 3: Propulsion & Related Systems

Engine

The owner's packet contains detailed engine operation and maintenance manuals. Be sure to read and understand these manuals *before* starting or doing any maintenance on the engine.

Engine Room Ventilation System

⚠ WARNING!



FIRE/EXPLOSION HAZARD

- Use of the blower system is *NOT A GUARANTEE* that explosive fumes have been removed.
- If you smell fuel, *DO NOT* start the engine and *DO NOT* turn on any electrical devices.
- If you smell fuel and the engine is already running, *SHUT OFF* the engine and *TURN OFF* all electrical devices. Investigate immediately.
- *DO NOT* obstruct or modify the ventilation system.

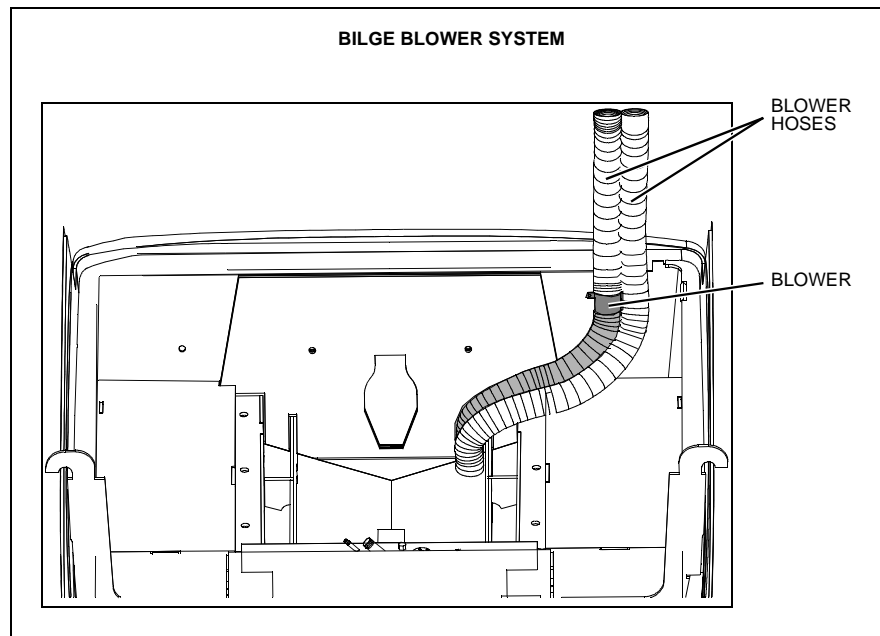

- The bilge blower removes explosive fuel fumes from the engine compartment.
- Fresh air is drawn into the compartment through the deck vents.
- The bilge blower switch is at the helm.

To make sure the engine compartment is ventilated with fresh air, run the bilge blower:

- For at least four minutes *before* starting the engine.
- During starting.
- Anytime your boat is running below cruising speed.

Fuel System

! WARNING!

 **FIRE, EXPLOSION AND OPEN FLAME HAZARD!**

- It is very important that the fuel system be inspected thoroughly the first time it is filled and at each subsequent filling.
- The fueling instructions in the *Cruiser & Yacht Owner's Manual* and the fuel recommendations in the engine operation manual *must* be followed.

! CAUTION

Avoid the storage or handling of gear near the fuel lines, fittings and tank.

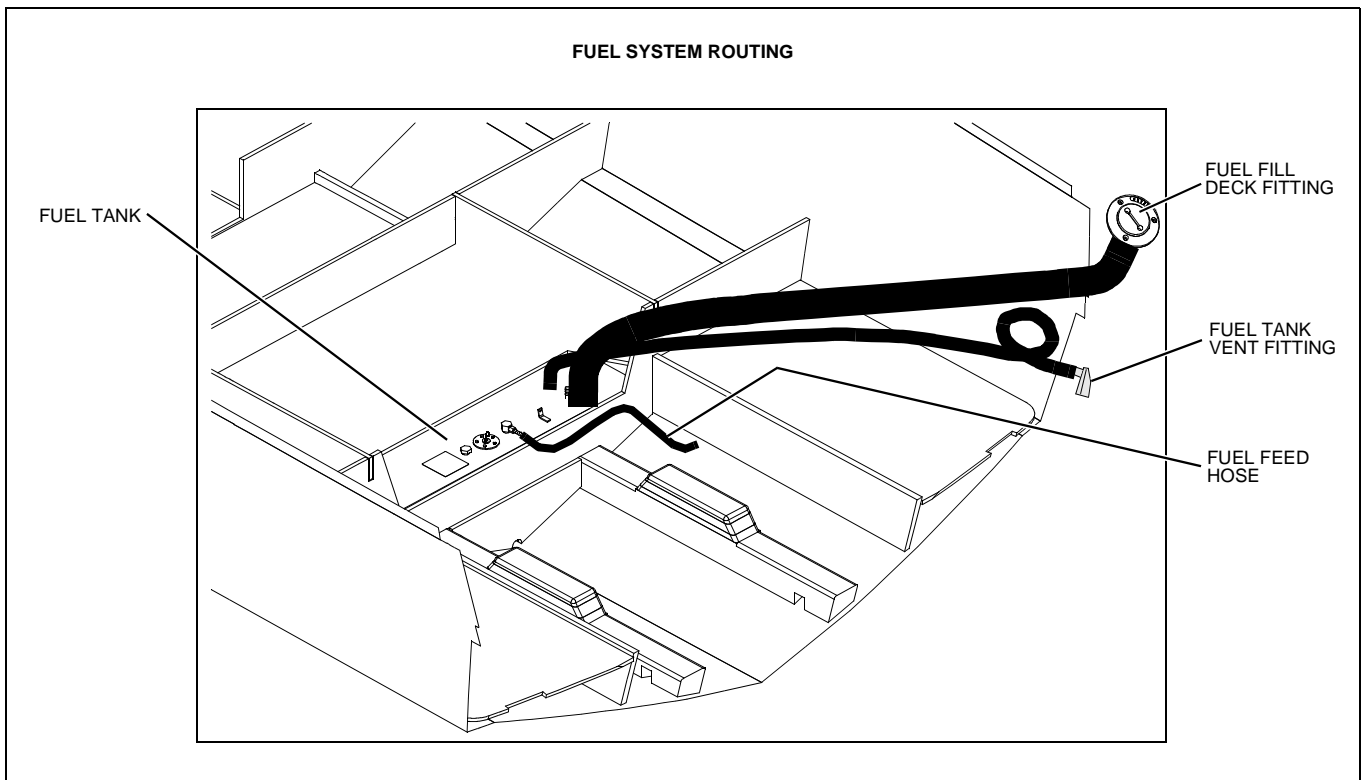

Fuel Fill and Vent

- The fuel fill fitting is marked “GAS”.
- The fuel tank vent is located below the fuel fill.
- If you experience difficulty filling the fuel tank, check to see if the fuel fill hose or vent hose is kinked or collapsed. If there are no visible signs of a problem, contact your local dealer.

Fuel Filters

- The fuel pickup tube (located inside the fuel tank) is equipped with a fine mesh screen filter.
- Also, when supplied by the engine manufacturer, a fuel filter is installed on the engine.
- Periodically replace the fuel filters to make sure they remain clean and free of debris.
- Ask your dealer about fuel additives that help prevent fungus or other buildup in your fuel tank.

Anti-siphon Valve

NOTICE

- **If an engine running problem is diagnosed as fuel starvation, check the anti-siphon valve. If the valve is stuck or clogged, change or replace it while the engine is shut down.**
- **NEVER** run the engine with the anti-siphon valve removed, except in an emergency.

- Your boat is equipped with an anti-siphon valve, which is an integral part of fuel system.
- The valve is located at the point where the fuel feed line attaches to the fuel tank.
- The valve is spring loaded and is opened by fuel pump vacuum.
- This valve will prevent fuel from siphoning from the tank in the event of a fuel line rupture.

Quick Oil Drain System

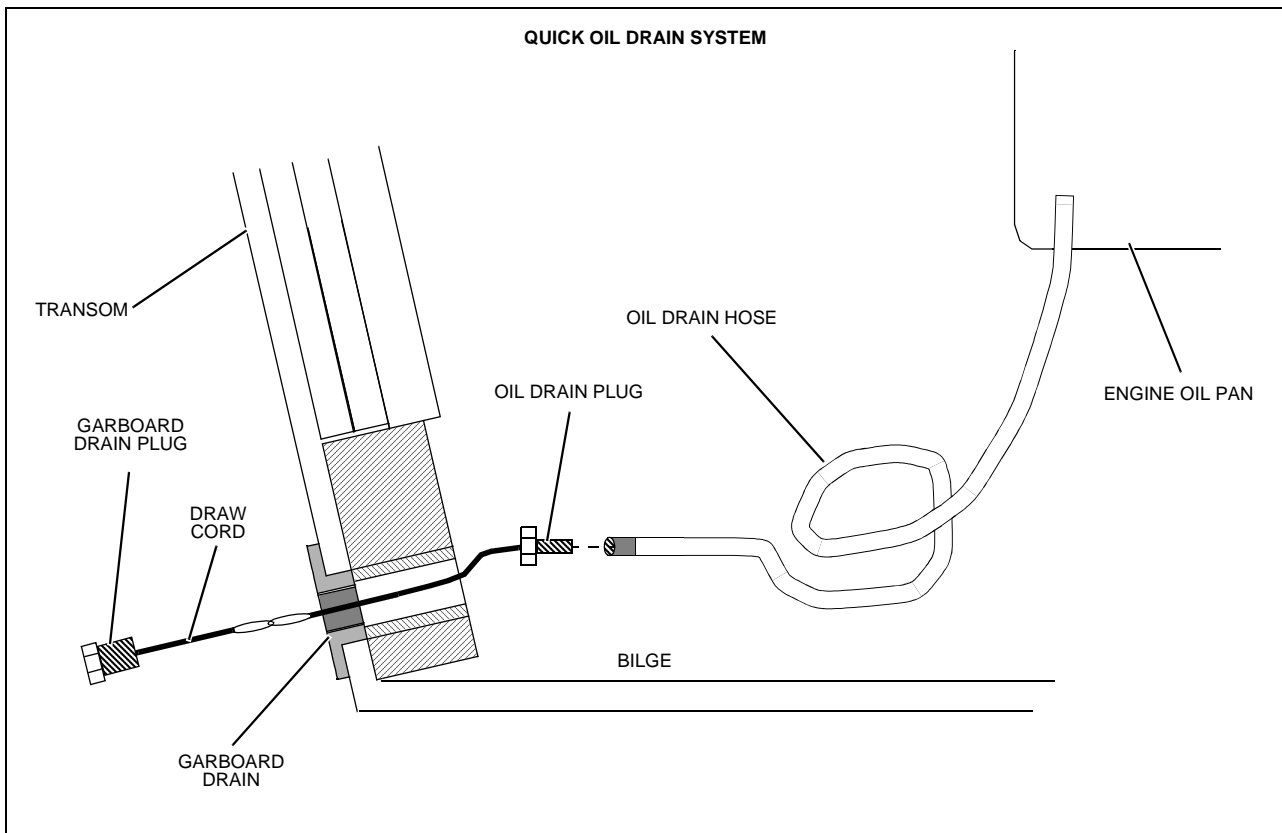

To drain the engine oil:

1. Remove the boat from the water.
2. Unscrew the garboard drain plug.
3. Pull the draw cord until the oil drain plug and the oil drain hose slide out of the garboard drain.
4. Place the end of the oil drain hose into a suitable container.
5. Unscrew the oil drain plug and drain the engine oil.
6. Replace the oil drain plug.
7. Push the drain hose back into the bilge.
8. Replace the garboard drain plug.

Always dispose of waste oil in accordance with local regulations.

Chapter 4: Controls

Steering

- This boat features a power assisted rack-and-pinion steering system.
- Check the fluid level in the power steering reservoir *every time you use your boat*.
- Boat steering is *not* self-centering.

Shift/Throttle

 WARNING!
<i>LOSS OF CONTROL HAZARD!</i>
Improper maintenance of shift/throttle hardware may cause a sudden loss of control!

- Carefully read and understand *all* of the information about the shift/throttle in the *Cruiser & Yacht Owner's Manual*.
- Also, read and understand the shifter/throttle and engine manuals included in your owner's packet.

Power Trim and Tilt

- The stern drive on your boat is equipped with power trim and tilt.
- Trim and tilt instructions are provided in the engine operation manual and the shifter/throttle manual is included in your owner's packet.

Trim Tabs (If Equipped)

⚠ **WARNING!**

LOSS OF CONTROL HAZARD!

Improper use of trim tabs will cause loss of control!

- *Do not* allow anyone unfamiliar with trim tabs to use them.
- *Do not* use trim tabs in a following sea as they will cause broaching or other unsafe handling characteristics.
- *Do not* use trim tabs to compensate for excessive unequal weight distribution.

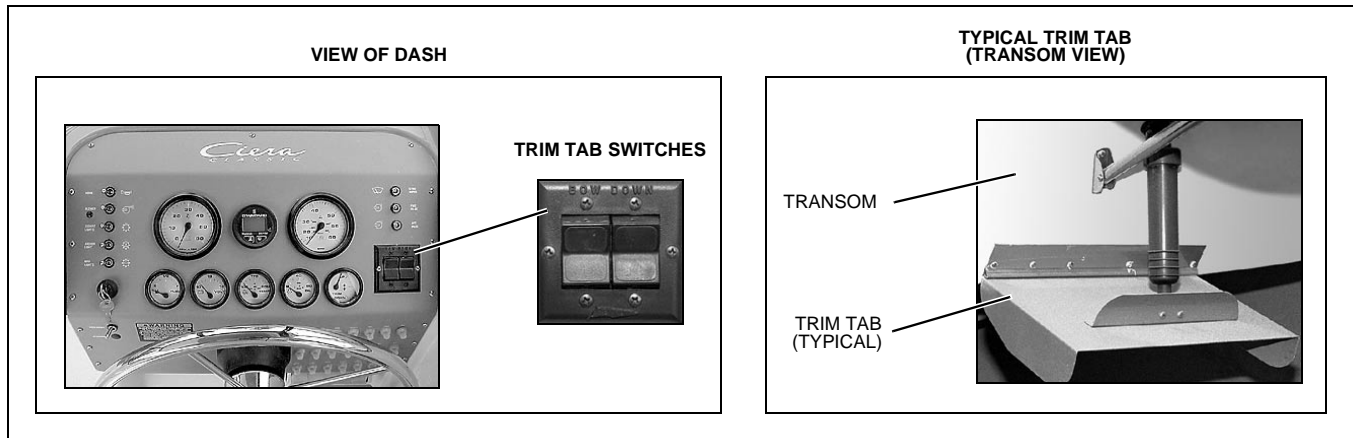

- The trim tabs may be used to help keep your boat level at cruising speeds.
- The trim tabs are controlled by two rocker switches at the helm.
- **Before** using the trim tabs read and understand the trim tab operation manual included in your boat's owner's packet.

Observe the following:

- Once cruising speed is reached, the port or starboard trim switch may be used (one at a time) to level the boat.
- Perform trim tab adjustment with several short touches to the switch rather than one long one.
- After each short touch allow several seconds for the hull to react.
- The trim tab hydraulic fluid reservoir is located in the engine compartment. The fluid level must be checked periodically (at least once a year) and refilled as necessary.

Chapter 5: Navigation & Communication Equipment

Before using these systems for the first time, read and understand the instruction manuals and observe the following:

VHF Radio (If Equipped)

Your boat may include a VHF (Very High Frequency) radio at the helm. The VHF radio can be used to access weather reports, summon assistance or contact other vessels as permitted by the FCC (Federal Communications Commission). Be sure to contact the FCC for licensing, rules and regulations concerning VHF radio usage.

Compass (If Equipped)

NOTICE

Compass accuracy can be affected by many factors. Have a qualified technician calibrate your compass. Make sure the technician gives you a deviation card which shows the corrections to apply in navigational calculations. Keep a copy of the deviation card at the helm.

Your boat may come equipped with a compass. Carefully read and follow the manufacturer's calibration and operating instructions provided in the boat's owner's packet.

Chapter 6: Plumbing

Bilge Pumps

NOTICE

Discharge of oil, oil waste or fuel into navigable waters is prohibited by law. Violators are subject to legal action by the local authorities.

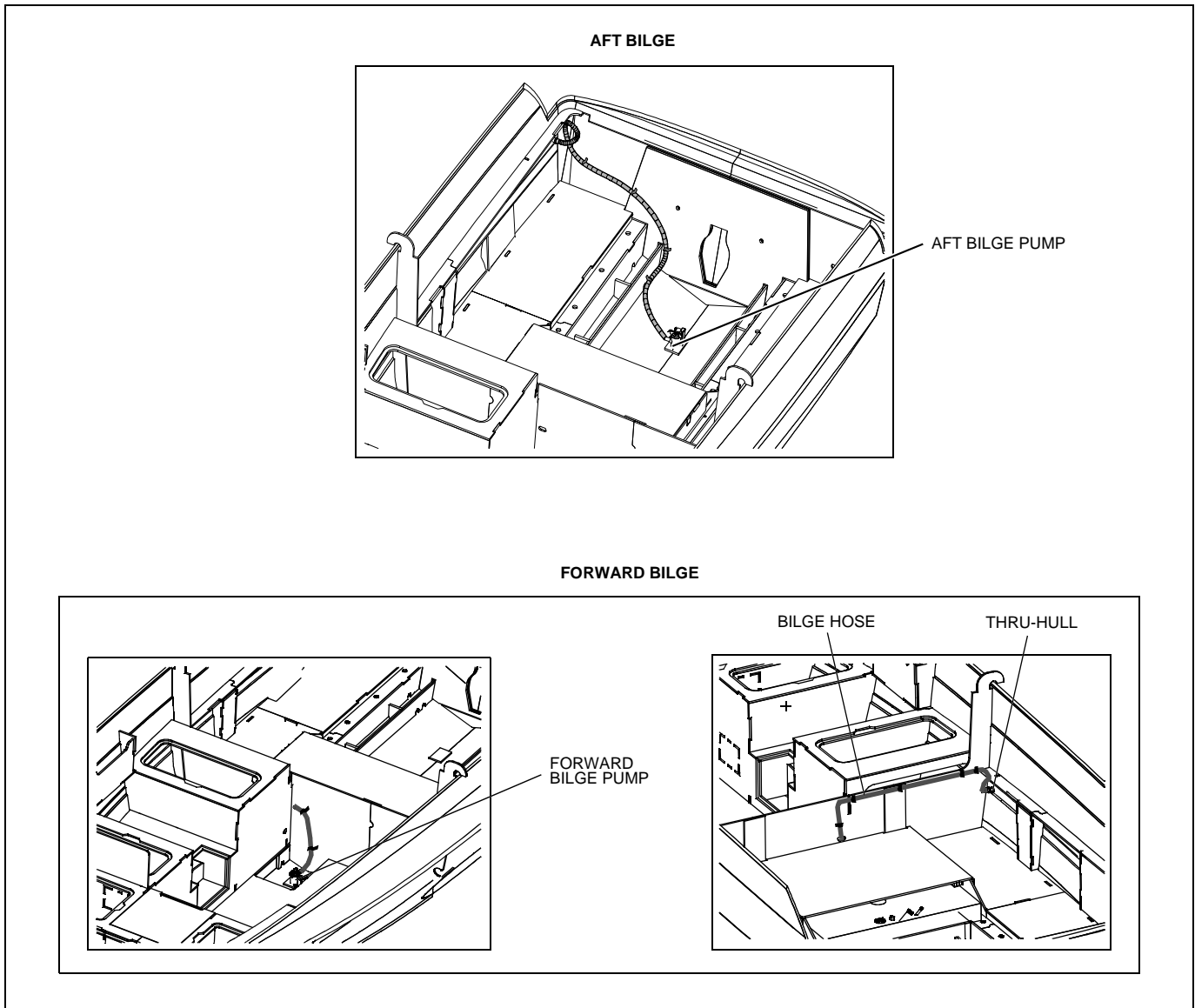

- Your boat is equipped with two automatic impeller-type bilge pumps which are used to pump water out of the bilge.
- The bilge pumps are controlled by automatic bilge pump float switches (autofloat switches) and/or switches at the helm.
- The bilge pumps are wired directly to the battery so they will normally function even when the boat is completely shut down and left unattended.

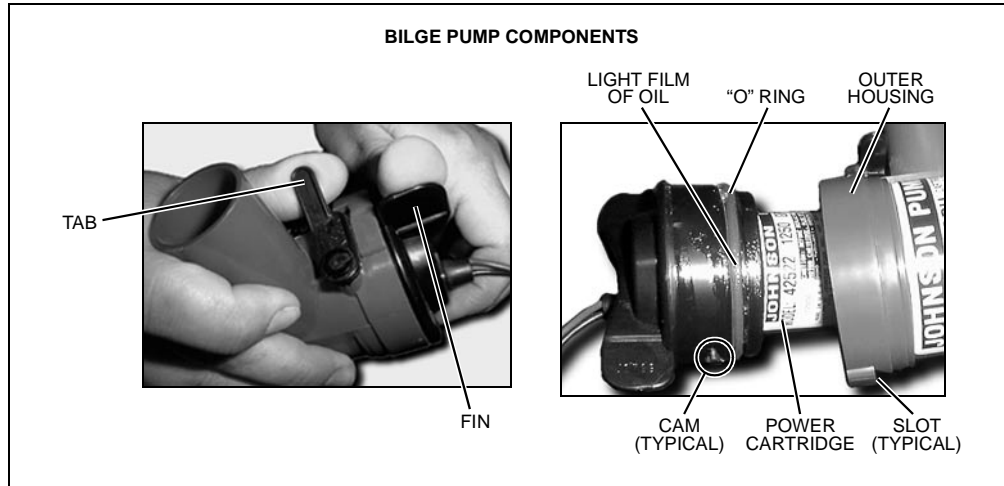
Bilge Pump Testing

- The bilge pumps are critical to the safety of your boat.
- Check the bilge pumps often to make sure they are working.

Test each pump often as follows:

1. Turn **On** the bilge pump switch at the helm.
 2. Any water in the bilge should pump overboard.
- If the pump motor is running but **not** pumping inspect the discharge hose for a kink or collapsed area.
 - If no problems are found, check the bilge pump housing for clogging debris as follows:
 1. Remove the power cartridge:
 - a. Lift the tab while rotating the fins counter-clockwise.
 - b. Lift out the power cartridge.
 - c. Clear the outer housing of debris.
 2. Reinstall the power cartridge:
 - a. Make sure the "O" ring is properly seated.
 - b. Coat the "O" ring with a light film of vegetable or mineral oil.
 - c. Align the cams on either side of the power cartridge with the two slots on the outer housing
 - d. Press the power cartridge into the housing while twisting clockwise.
 3. Check the reinstallation by trying to twist the fins counter-clockwise without lifting the tab; the cartridge should stay in place.

Autofloat Switches

- The automatic bilge pumps use electromagnetic float switches (autofloat) to turn **On** the pumps whenever water rises above a preset level in the bilge.
- One autofloat switch is mounted next to each automatic bilge pump.
- The autofloat switches are wired directly to the battery and **will** normally function even when the boat is completely shut down and left unattended.

Test the autofloat switches often as follows:

1. Push the float switch test button **up** to turn **On** the bilge pump.
 - If the pump does **not** turn **On**, check the inline fuse.
 - If the fuse is good but the switch still doesn't work, it may mean the switch is bad or possibly the battery is low.
2. Push test button all the way **down** to return the float switch to auto mode.

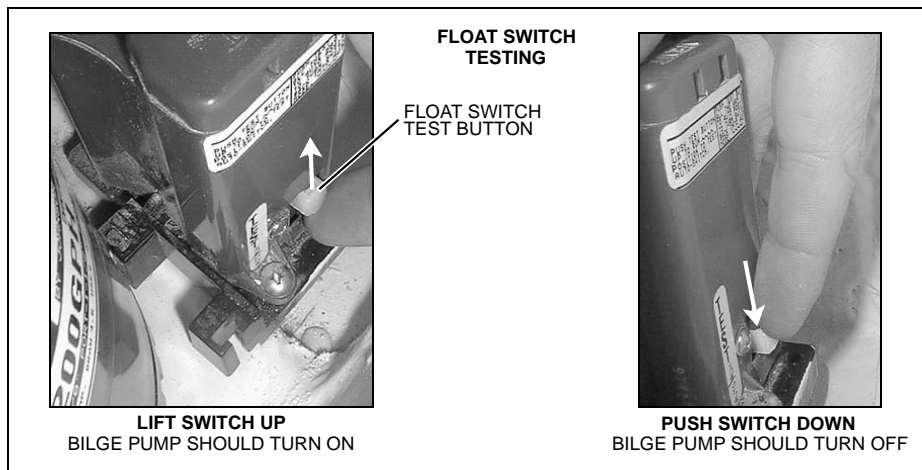

CAUTION!

When the test is completed on each float switch, you **MUST** push the test button *all the way down* to the auto position to return the switch to auto mode!

Seawater Systems

Seacocks



CAUTION!

SYSTEM DAMAGE HAZARD!

- Before using a seawater intake system, make sure that the system's seacock is in the **OPEN** position before the system is started and keep the seacock **Open** until the system is shut **Off**.
- Close the seacocks whenever the systems will **not** be used for long periods of time.

A seacock is a valve, controlled by a 90° lever, used to manage the intake of seawater through the hull and below the water line. Seacocks are typically used on your boat in the following seawater intake systems:

- Marine head (toilet)
- Air conditioning system (if equipped)

Before using any of these systems, make sure that the system's seacock is **Open** and remains **Open** until the system is shut **Off**.

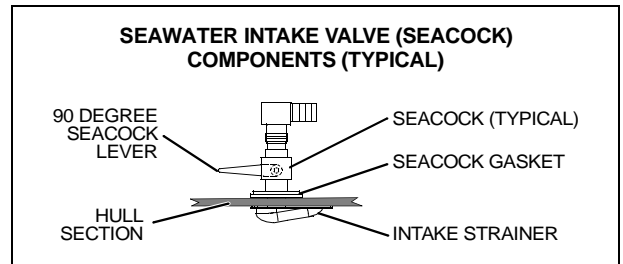

Seawater Strainers

- Seawater strainers are used in water pickup systems to filter incoming seawater.
- A seawater strainer is located near each system's seacock.
- Check the strainers for leaks and/or debris *every time you use your boat*.
- If debris is found, clean the seawater strainer as follows:



CAUTION!

FLOODING HAZARD!

- The seacock that sends seawater to the strainer must be **CLOSED** before disassembling the seawater strainer to prevent the boat from taking on water through the seawater strainer assembly.
- Keep the seacock **CLOSED** until the seawater strainer is completely reassembled.

SYSTEM DAMAGE HAZARD!

- After reassembling the seawater strainer, make sure that the seacock valve is **OPEN** before using the component/system.

1. Turn **Off** the component or system (marine head, air conditioning system, etc.) that the strainer is connected to.
2. **Close** the seacock that sends seawater to the strainer you are about to clean. The seacock must remain **Closed** until the strainer is completely reassembled.
3. Take apart the seawater strainer.
4. Remove the debris.
5. Flush the strainer with water.
6. Reassemble the seawater strainer.
7. **Open** the seacock and check for leaks around the strainer.
8. If no leaks are found, you may use the component or system.

Freshwater System



WARNING!

- Only use safe drinking (potable) water in your boat's freshwater system.
- Only use a sanitary drinking water hose to fill the water tank or connect to city water.
- Never use a common garden hose for drinking water.

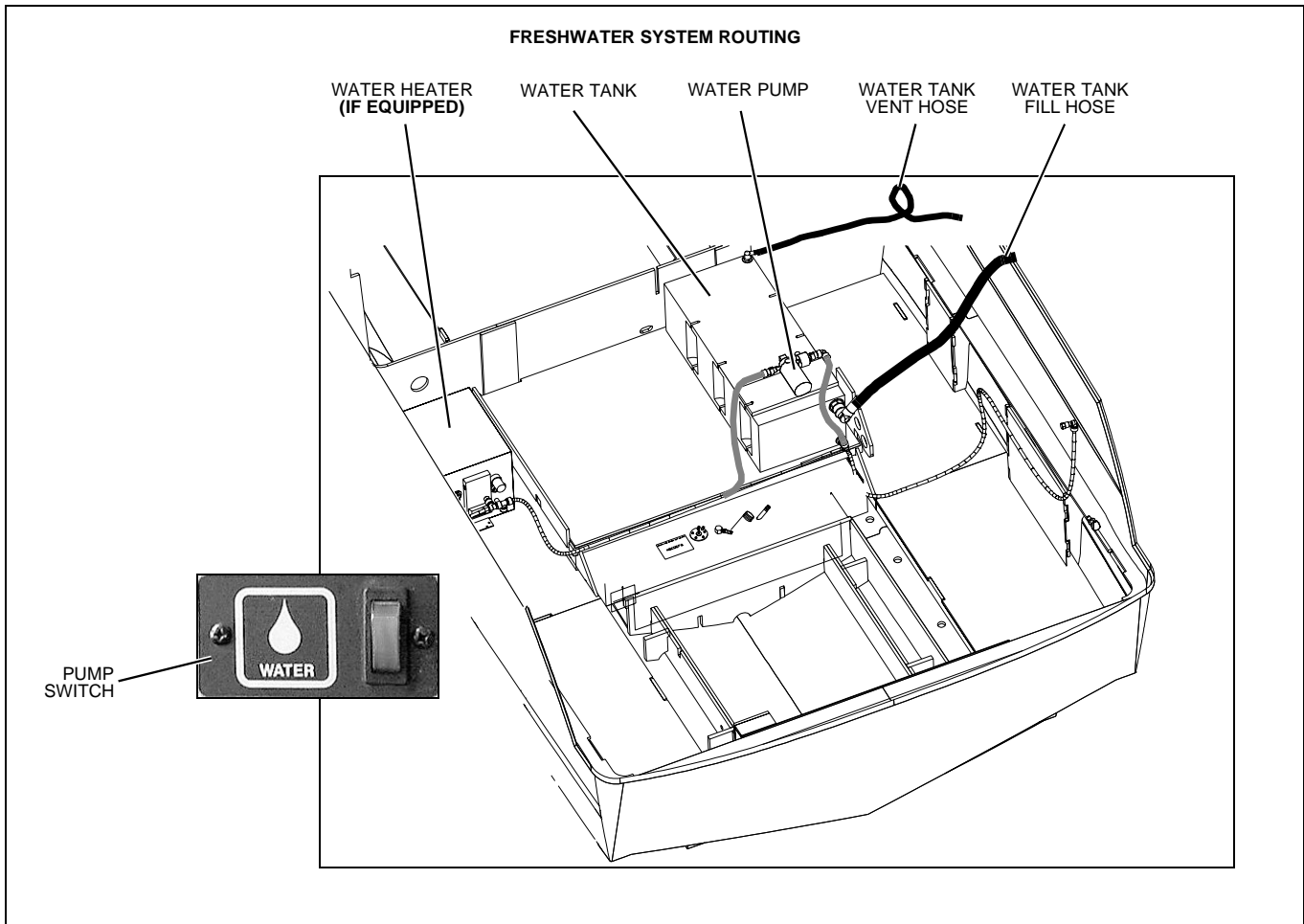

- Read the *Freshwater System* section in the *Cruiser & Yacht Owner's Manual*.
- Your boat is equipped with a pressure type (demand) freshwater (potable) system.
- This system can be pressurized by turning **On** the water pump.
- See the *Component Location* section of this *Supplement* for the location of the water pump switch.
- Since the water pump requires DC power, the battery switch **must** be in the "1", "2" or "BOTH" position for the pump to work.

Observe the following about the freshwater system:

- Turn **Off** the water pump when the boat is **not** in use or the water tank is empty.
- Inspect and clean the water filter often (located on the water pump).
- When your boat is to be left unattended for long periods of time, pump the water tank dry to prevent stored water from becoming stagnant and distasteful.
- If the freshwater system needs to be disinfected, ask your dealer about treatments available for your boat's system.

Freshwater System Winterization

CAUTION!

WATER SYSTEM DAMAGE HAZARD!

Never blow compressed air through the water system when all of the faucets are Closed.

1. Turn **On** the water system switch.
2. **Open all** of the faucets and showers and let the water system drain completely.
3. Turn **Off** the water system switch.

Any remaining water **must** be removed from the water lines. There are two ways to remove the remaining water from the lines:

- Compressed Air
- Gravity Draining

Compressed Air

You **must** have an air compressor with an air hose and an air nozzle.

1. Remove the water line from the outlet side of the water pump (opposite side from filter).
2. **Open** the faucet that is furthest away from the water pump.
3. Place the air nozzle against the end of the just removed water line and blow air through the system.
4. When water stops coming out of the **Open** faucet, stop the air and **Close** the faucet.
5. One at a time, repeat this process on **all** faucets and showers.

Gravity Draining

1. **Open all** faucets and showers.
2. Remove the drain plug from the tee fitting on the freshwater tank.
3. When the water has stopped draining from the freshwater tank, replace the drain plug.

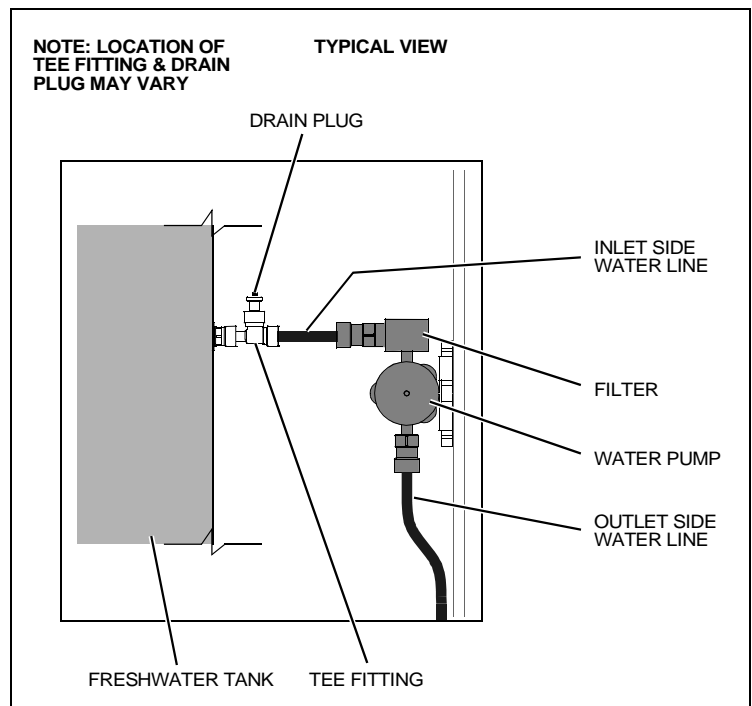

Transom Shower (If Equipped)

- The water pump switch **must** be turned **On** before using the transom shower.
- Be sure to read the manufacturer's instructions, provided in your owner's packet.

Water Heater

! WARNING!

! HOT HAZARD!
Water heated by the water heater can reach temperatures hot enough to scald the skin.

! CAUTION!

WATER HEATER DAMAGE HAZARD!

- **DO NOT** turn on the water heater electrical circuit on the AC panel until the water heater tank is **COMPLETELY** filled with water.
- Even momentary operation in a dry tank will damage the heating elements.
- Warranty replacements **WILL NOT** be made on elements damaged in this manner.
- The tank is full if water flows from the tap when the hot water is turned *On* in the galley.
- The water heater should be drained and the power turned *OFF* when the possibility of freezing exists.

NOTICE

If your boat is connected to shore power but the water heater is *not* working:

- Make sure the water heater circuit breaker on the AC panel is switched *On*.

If the circuit breaker on the AC panel is *On*, but the water heater is still *not* working:

- Consult with your dealer about checking the "push to reset" circuit breaker located on the water heater.

- The water heater is connected to the AC power system, therefore, you must make sure that the water heater breaker on the AC panel is turned *On* before water will be heated.
- Read the manufacturer's instruction manual supplied in your boat's owner's packet and observe the warnings above.

Winterizing the Water Heater

1. Turn *Off* the water heater breaker.
 2. Disconnect the hose (A) attached to the pressure relief valve (B).
 3. If there is any water in this hose, drain it into the bilge or into a bucket.
 4. *Open* the pressure relief valve (B).
 5. *Open* the drain valve (C).
- Leave the pressure relief and drain valves *Open* until you fit out the boat after storage.



Drain Systems

Sink Drains

Gray water (water from the sinks) is gravity drained overboard.

Deck Drains

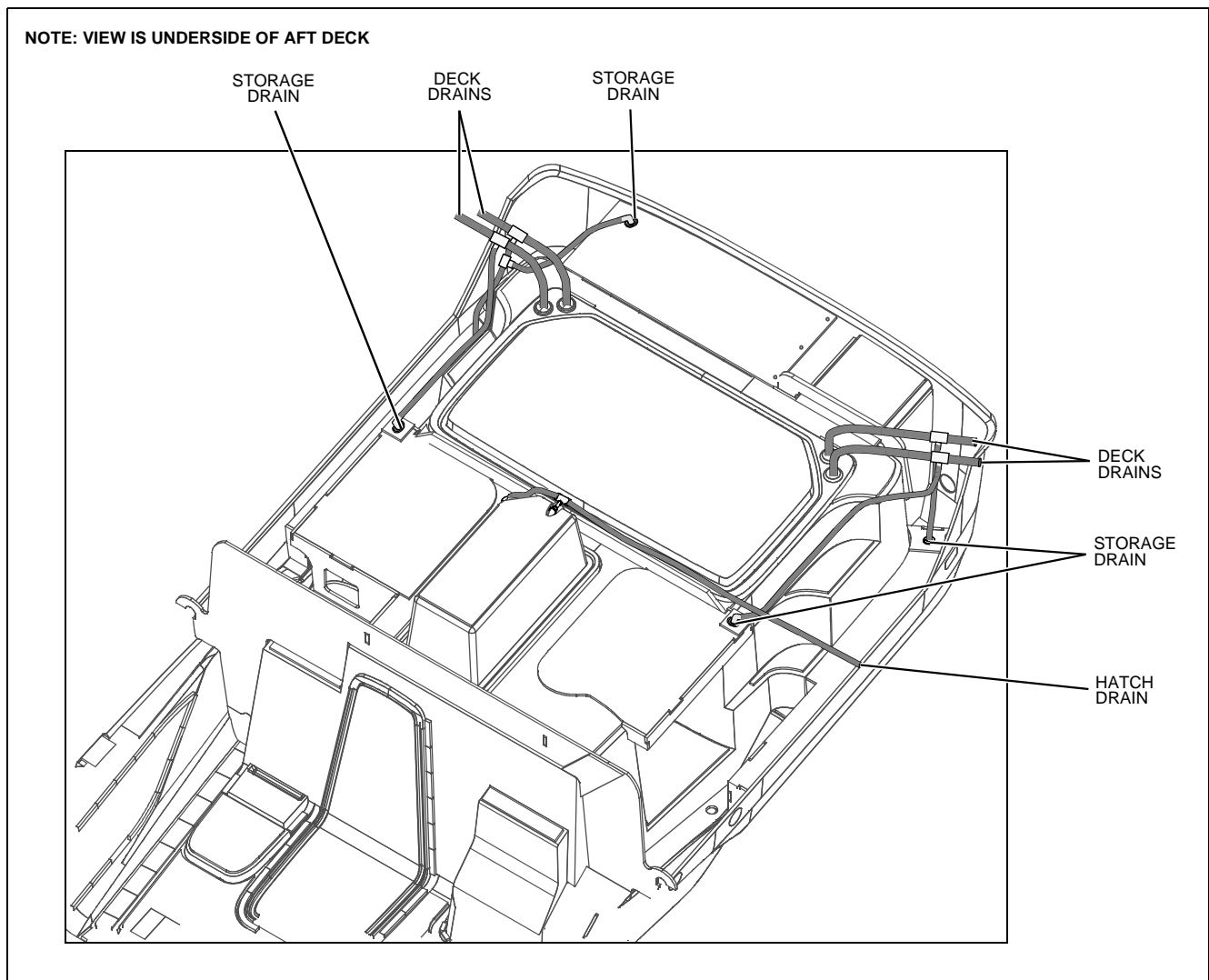

Water on the deck is drained overboard through the deck drains. Keep the deck drains free of debris.

Portable Toilet (If Equipped)

Read the manufacturer's operating instructions supplied in your owner's packet before using the portable toilet.

Marine Head with Holding Tank (If Equipped)

NOTICE

Check with local authorities for regulations regarding the legal use of marine head systems.

- Read the marine head operation and maintenance manual (included in your boat's owner's packet).
- The holding tank is plumbed to a waste fitting on the deck for dockside pump-out.
- Check the content level of the holding tank by looking at the side of the tank.
- Empty the holding tank often.

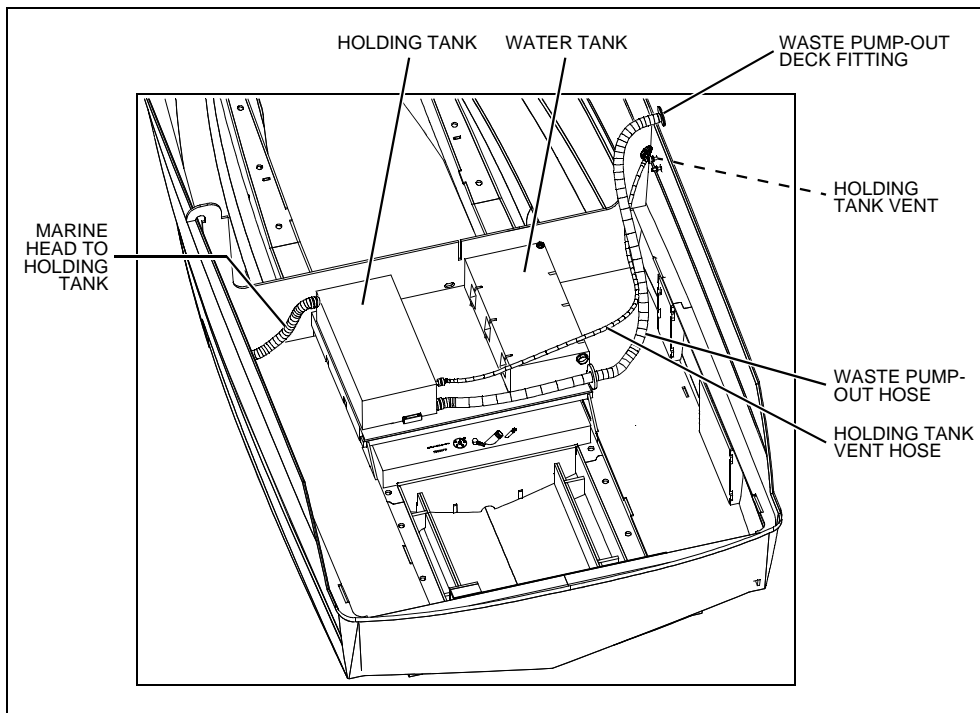

Using the marine head:

1. **Open** the head's seawater intake valve (seacock).
2. **Before** using the head, pump enough water into the bowl to wet the sides.
3. After use, pump until the bowl is thoroughly cleaned. Continue pumping a few more times to clean the lines.
4. If excess waste causes the water to rise in the bowl, stop pumping until the water recedes.

Winterizing The Marine Head

1. Shut **Off** the intake seacock, and pump the head until the bowl is dry.
2. Remove the drain plug in the base and pump again to remove **all** of the water.
- **Do not** fill the bowl with anti-freeze.
- **Close** the intake seacock while the boat is underway or whenever the boat is left moored in the water.

Macerator (If Equipped)**NOTICE**

Check with local authorities for regulations regarding the legal use of marine head systems.

To use the macerator to pump waste directly into the water (where regulations permit):

1. **Open** the underwater discharge seacock.
2. Press both macerator switches at the same time to run the pump. **Do not** continue running the macerator if the waste holding tank is empty.
3. **Close** the underwater discharge seacock when you are done pumping.

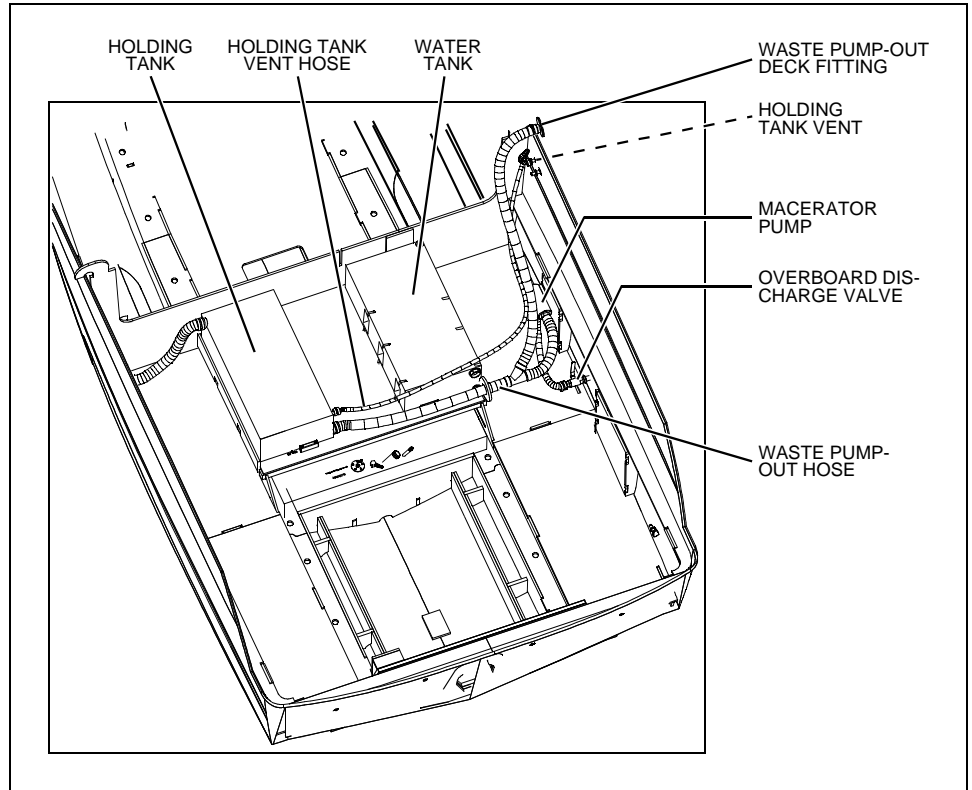

Chapter 7: Deck Equipment

Cleats and Tow Eyes



WARNING!

PERSONAL INJURY and /or PRODUCT or PROPERTY DAMAGE HAZARD!

- ***NEVER*** lift the boat using the bow and stern eyes or the cleats.

Carefully read the section on towing in the *Cruiser & Yacht Owner's Manual* **before**:

- Towing anything behind the boat.
- Being towed by another vessel.

Chapter 8: Appliances & Entertainment Systems

NOTICE

Always keep an approved ABC-type fire extinguisher in galley area.

All appliances installed on your boat come with their own manuals. These manuals contain detailed instructions and important safeguards. Thoroughly read and understand these manuals *before* using your boat's appliances.

- Make sure the AC breaker is turned *On* for the appliance you wish to use.

Refrigerator (If Equipped)

Your boat features a dual voltage, 120-volt AC/12-volt DC, refrigerator. The refrigerator runs on 12-volt DC power unless 120-volt AC power is being supplied by shore power and the AC refrigerator breaker is *On*.

Microwave Oven (If Equipped)

Before attempting to use the microwave oven, make sure the breaker switch on the AC master panel is *On*.

Electric Stove (If Equipped)





WARNING!





BURN/SCALDING and/or FIRE HAZARD!

- Read the stove's instruction manual *before* using.
- *Always* keep an approved ABC-type fire extinguisher in galley area.
- *Do not* use the stove while underway.
- Any non-cooking devices on or near your stove during use are potential fire hazards!
- *DO NOT* touch burners, grates or nearby surfaces as they may be hot even when they are dark in color. Areas near burners and grates may become hot enough to cause burns.
- During and after use, *do not* touch or let clothing or other flammable material come in contact with heated units or areas near the units (burner tops, main frame sides and back, sea rails and pot holders) until they have had sufficient time to cool.

Alcohol/Electric Stove (If Equipped)

 DANGER!	
 DANGER CARBON MONOXIDE	<p><i>CARBON MONOXIDE POISONING HAZARD!</i></p> <ul style="list-style-type: none"> • The alcohol stove is a source of dangerous carbon monoxide gas (CO). • <i>BEFORE</i> using the alcohol stove, <i>Open</i> doors and windows to make sure there is enough fresh air for ventilation.

 WARNING!	
<ul style="list-style-type: none"> • Open flame cooking appliances consume oxygen, this can cause asphyxiation or death. • Maintain open ventilation. 	

 WARNING!	
 <p><i>BURN/SCALDING and/or FIRE HAZARD!</i></p> <ul style="list-style-type: none"> • Read the stove's instruction manual <i>before</i> using. • <i>Always</i> keep an approved ABC-type fire extinguisher in galley area. • <i>Do not</i> use the stove while underway. • Any non-cooking devices on or near your stove during use are potential fire hazards! • <i>DO NOT</i> touch burners, grates or nearby surfaces as they may be hot even when they are dark in color. Areas near burners and grates may become hot enough to cause burns. • During and after use, <i>do not</i> touch or let clothing or other flammable material come in contact with heated units or areas near the units (burner tops, main frame sides and back, sea rails and pot holders) until they have had sufficient time to cool. 	

 CAUTION!	
<p><i>PRODUCT DAMAGE HAZARD!</i></p> <p>To prevent overheating which can destroy the electric burner elements, <i>NEVER</i> attempt to use both alcohol and electric burners simultaneously.</p>	

Audio & Visual Equipment

NOTICE	
AM radio reception may be impaired anytime the engine is running.	

Chapter 9: Convertible Seats, Beds, & Tables

Dinette/Berth

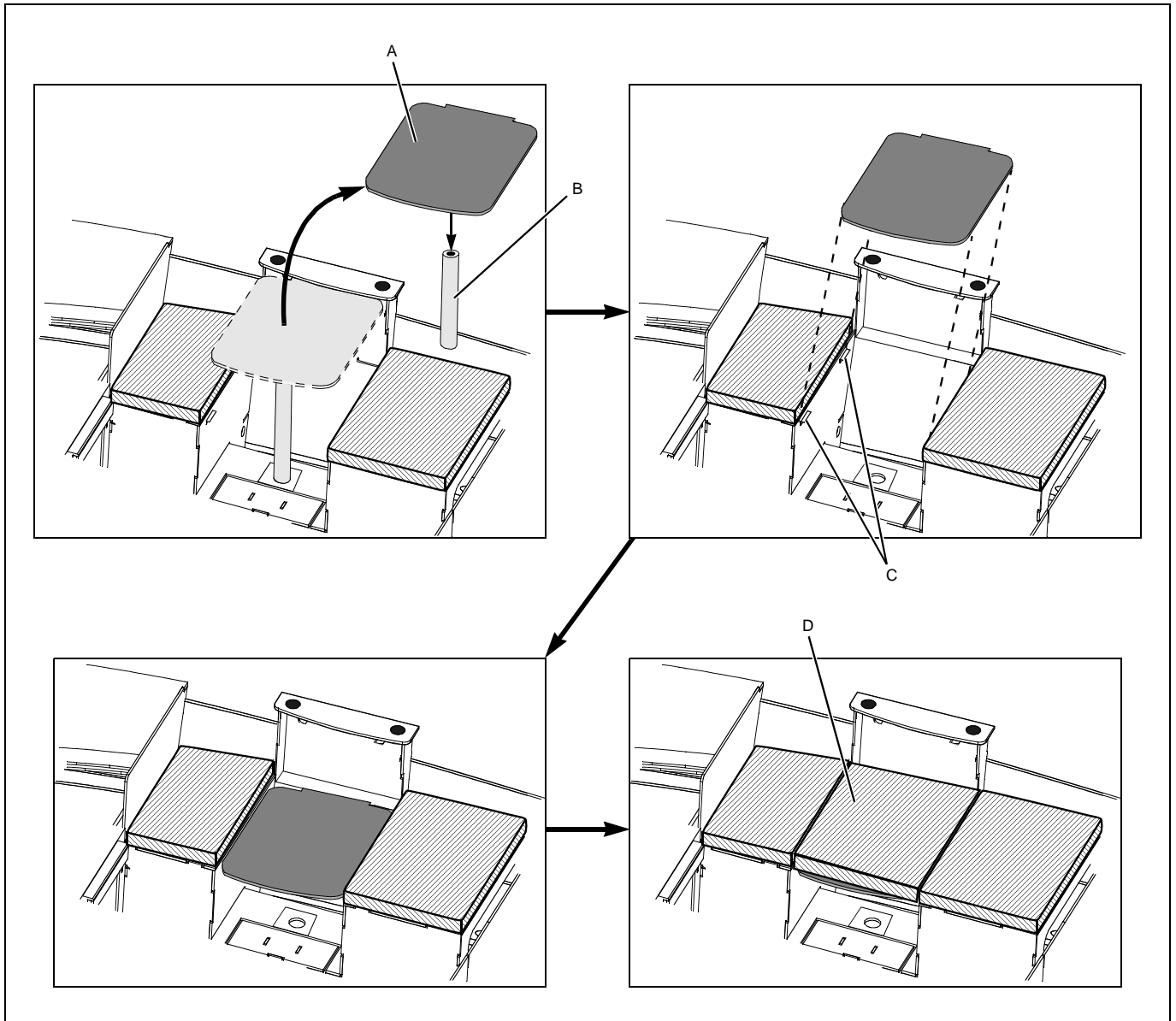

The dinette table can be removed and the dinette area can be converted into a berth.

1. Lift the table (A) and remove the table leg (B).
2. Place the table so that it fits securely on the support brackets (C) at the front of the dinette seats.
3. Place the filler cushion (D) on top of the table.

Chapter 10: Lights

Care and Maintenance

All of the lights installed on your boat are of top quality, but you should be aware that failure may periodically occur for a variety of reasons:

1. There may be a blown fuse - *replace the fuse.*
2. The bulb may be burned out - *carry spare bulbs for replacement.*
3. A wire may be damaged or may have come loose - *repair as required.*
4. The bulb base may be corroded - *clean the base and coat it with non-conductive electrical lubricant.*

Navigation Lights

 CAUTION!
Avoid the storage of gear where it would block navigation lights from view.

Read and understand the navigation light section of *Cruiser & Yacht Owner's Manual*.

Interior & Exterior Lights

 CAUTION!
<ul style="list-style-type: none"> • Be conservative in the use of battery power. • Prolonged use of cabin interior lights (overnight) <i>will</i> result in a drained battery.

- The lights are powered by the boat's 12-volt DC system.
- The battery switch ***must*** be in the 1, 2 or BOTH position for the lights to work.
- There are ***On/Off*** light switches for different sets of lights on the cabin wall.
- Some individual lights also have a switch on the light.

Chapter 11: Air Conditioning (If Equipped)

Air Conditioning System (If Equipped)

⚠ DANGER!



DANGER
CARBON MONOXIDE

CARBON MONOXIDE POISONING HAZARD!

Dangerous carbon monoxide gas (CO) can be brought into the boat through the air conditioning system.

⚠ CAUTION!

SYSTEM DAMAGE HAZARD!

The air conditioning system's seacock *must* be **OPENED** before turning on the air conditioner and *must* remain **OPEN** during use.

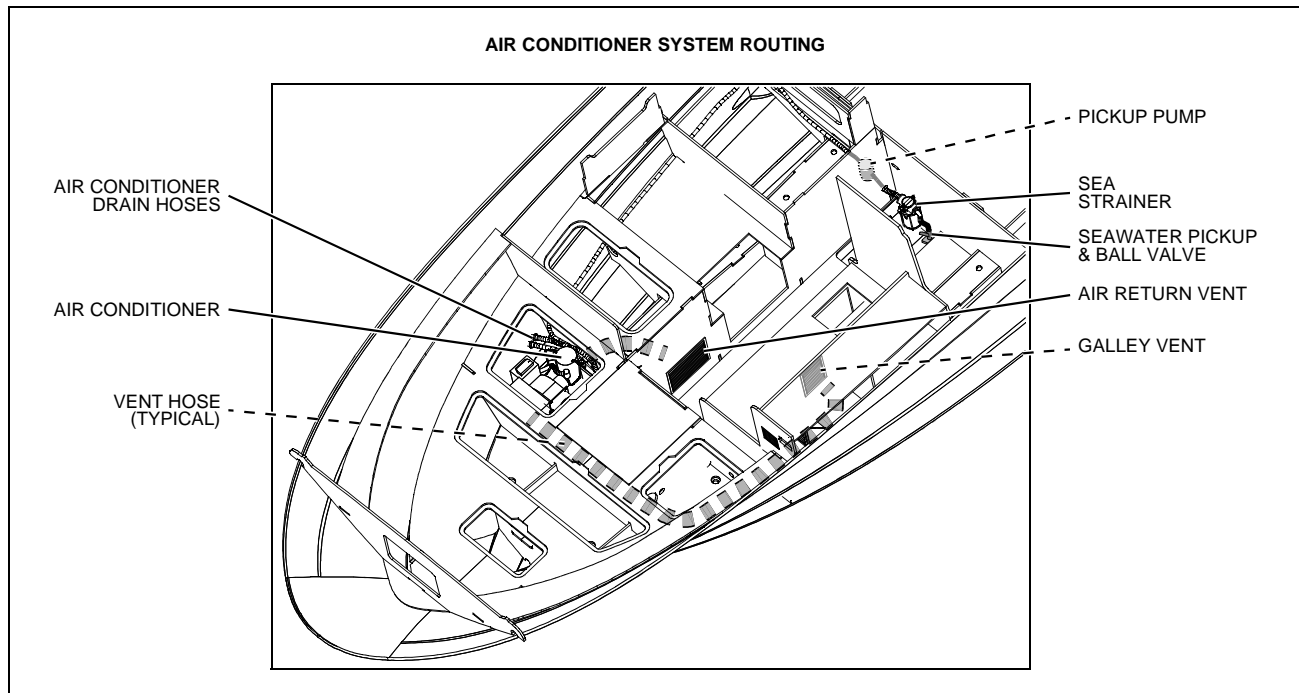

Read the air conditioner manual, included in your owner's packet, **before** using the air conditioning system.

- **Before** using the air conditioning system, make sure the breakers on the AC main distribution panel are turned **On** and make sure the system's seawater pickup seacock is **Open**. The seacock **must** remain **Open** anytime the air conditioner is in use.
- Check the seawater pickup strainer for debris according to the directions given in the *Seawater Strainer* section of this *Supplement*.

Chapter 12: Electrical System

DANGER!



EXTREME FIRE, SHOCK & EXPLOSION HAZARD!

- To minimize the risks of fire and explosion, **NEVER** install knife switches or other arcing devices in the fuel compartments.
- **NEVER** substitute automotive parts for marine parts. Electrical, ignition and fuel system parts were designed and manufactured to comply with rules and regulations that minimize risks of fire and explosion.
- **DO NOT** modify the electrical systems or relevant drawings.
- Have qualified personnel install batteries and/or perform electrical system maintenance.
- Turn **OFF** the battery switch **BEFORE** doing any work in the engine spaces.

WARNING!



FIRE & EXPLOSION HAZARD!

- Fuel fumes are heavier than air and *will* collect in the bilge areas where they can be accidentally ignited.
- Visually and by smell (sniff test), check the engine and fuel compartments for fumes or accumulation of fuel.
- **ALWAYS** run the bilge blowers for at least four minutes *before* turning on electrical devices, starting the engine, or electrical system maintenance.
- Minimize the danger of fire and explosion by not exposing the batteries to open flame or sparks. **NEVER** smoke anywhere near the batteries.

CAUTION!



SHOCK & ELECTRICAL SYSTEM DAMAGE HAZARD!

NEVER disconnect the battery cables while the engine is running since it can cause damage to your boat's electrical system components.

NOTICE

Electrical connections are prone to corrosion. To reduce corrosion caused electrical problems, keep *all* electrical connections clean and apply a spray-on protectant that is designed to protect connections from corrosion.

12-Volt DC System

Batteries

The batteries supply electricity for lights, accessories, and engine starting.

The Electrical section of Chapter 8, in the *Cruiser & Yacht Owner's Manual*, provides battery care and maintenance instructions.

Fuses and Circuit Breakers

- Fuses and circuit breakers for engines and main accessory power are on the DC main distribution panel and on the battery switch panel.
- Some equipment may have secondary fuse protection at the unit, behind the battery switch panel or at the batteries.
- Electronics power is provided at the helm station.

Battery Switch

- The battery switch has four (4) positions.
- Some "Standby Loads", such as the CO monitor, the automatic bilge pumps, and the stereo memory, are *not* affected by the battery switch since they are wired directly to the battery (see the *Wiring Diagrams* in this Supplement for more details).

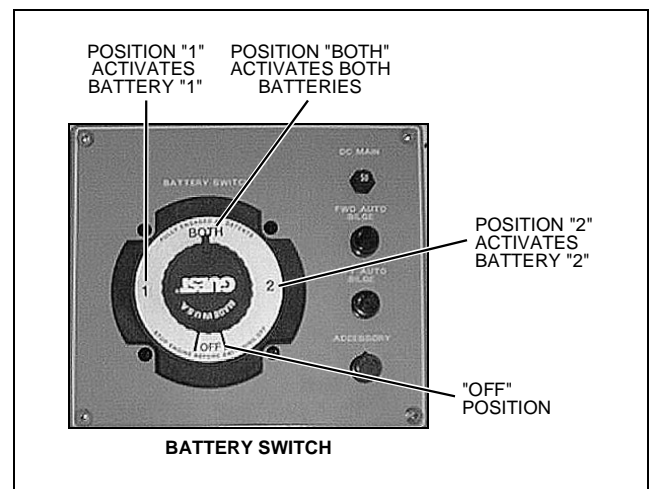

Battery Switch Positions

NOTICE

Since the batteries on your boat were dealer-installed, the battery switch positions listed below may vary. Make sure you get a full explanation of battery switch use from your selling dealer.

Battery Switch Position	Engine Starting	Accessories and Lights	Engine Alternator	Battery Charger
POSITION <u>1</u>	Battery <u>1</u> Provides Starting Power	Battery <u>1</u> Provides Power for Accessories and Lights	Charges Battery <u>1</u>	Charges BOTH Batteries
POSITION <u>2</u>	Battery <u>2</u> Provides Starting Power	Battery <u>2</u> Provides Power for Accessories and Lights	Charges Battery <u>2</u>	Charges BOTH Batteries
POSITION <u>BOTH</u>	BOTH Batteries Provide Starting Power	BOTH Batteries Provide Power for Accessories and Lights (not advised unless engine is running)	Charges BOTH Batteries	Batteries will NOT Charge Properly

Alternator

The engine alternator will keep the batteries properly charged when running at cruising speeds.

Battery Charger (If Equipped)

 CAUTION!
<p><i>ENGINE & ELECTRICAL SYSTEM DAMAGE HAZARD!</i></p> <p><i>NEVER</i> run the boat's engine and the battery charger at the same time.</p>

 CAUTION!
<p>The battery charging systems (alternator and battery charger) installed on your boat are designed to charge conventional lead-acid batteries. Before installing gel-cell or other new technology batteries, consult with the battery manufacturer about charging system requirements.</p>

Thoroughly read and understand the battery charger manual (provided in your owner's packet) *before* using the battery charger for the first time.

- The battery charger will charge the boat's batteries whenever the boat is plugged into 120V/60Hz shore power and the "BATTERY CHARGER" AC breaker is *On*.
- The battery switch can be in any position during charging.
- You may use DC powered electrical systems, such as the lights and stereo when the battery charger is *On*, but there *will* be a corresponding drop in charger performance.

12-Volt Accessory Outlet

 CAUTION!
<p><i>DO NOT</i> use the 12-volt accessory outlet with a cigarette or cigar lighter. High temperatures may melt the outlet.</p>

- Your boat is equipped with a 12-volt accessory outlet at the helm.
- The outlet can be used with any 12-volt device which draws 15 amps or less.
- The 12-volt accessory outlet is protected by a 15 amp circuit breaker on the main circuit breaker panel.

120-Volt AC System (If Equipped)



CAUTION!

WATER HEATER DAMAGE HAZARD!

- **DO NOT** turn on the water heater AC panel electrical circuit until the water heater tank is **COMPLETELY** filled with water.
- The tank is full if water flows from the tap when the hot water is turned *On* in the galley.
- Even momentary operation in a dry tank will damage the heating elements.
- Warranty replacements **WILL NOT** be made on elements damaged in this manner.

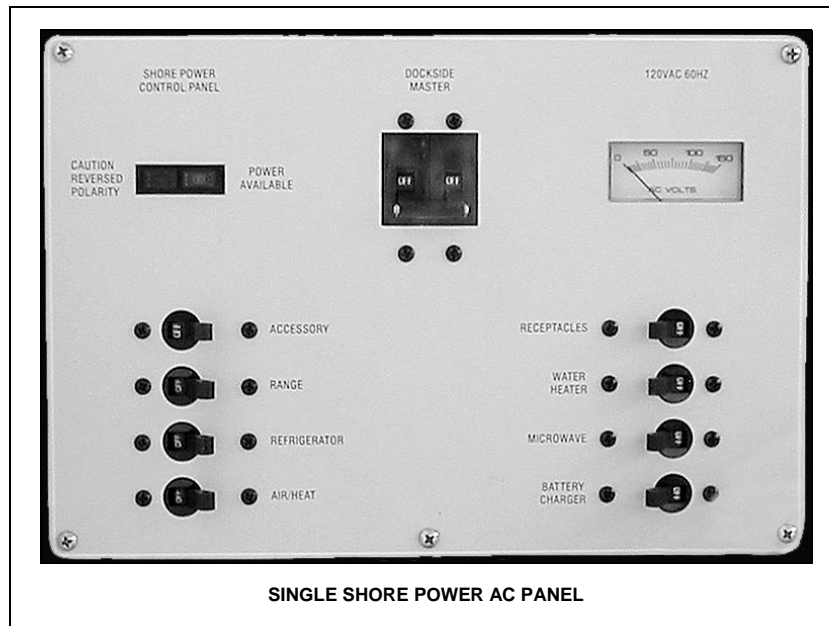





NOTICE

When using shore power the simultaneous use of several AC components can result in an overloaded circuit. It may be necessary to turn *Off* one or more accessories in order to use another accessory.

- The 120V/60Hz AC system can be energized by shore power.
- The master circuit breakers, located on the AC panel, provide power source selections to AC powered accessories. Individual breakers **must** be turned *On* to supply power to the accessories you wish to use.
- The AC panel may contain inactive circuit breakers for accessories that are **not** available for this model boat.

Shore Power

DANGER!





FIRE, EXPLOSION & SHOCK HAZARD!

- **DO NOT** alter shore power connectors and use only compatible connectors.
- Before plugging in or unplugging the shore power cord to your boat, make sure *all* breakers and switches on the AC master panel are turned **OFF**.
- To prevent shock or injury from an accidental dropping of the “hot” cord into the water, **ALWAYS** plug the shore power cord to the boat inlet first; then to the dockside outlet. When unplugging from shore power, unplug the shore power cord from the dockside outlet first.
- **NEVER** leave a shore power cord plugged in to the dockside outlet only.
- Only use shore power cords approved for marine use. **NEVER** use ordinary indoor or outdoor extension cords that are *not* rated for marine use.

WARNING!

SHOCK & ELECTRICAL SYSTEM DAMAGE HAZARD!

- Monitor the polarity indicator lights **EVERY TIME** you connect to shore power.
- If a red reversed polarity light turns *On* when you are connecting to shore power, **DO NOT** turn on the main breaker switches.
- Instead, **IMMEDIATELY** unplug the shore power cord (**ALWAYS** from the dockside outlet first) and alert marina management.

WARNING!

SHOCK & ELECTRICAL SYSTEM DAMAGE HAZARD!

- Periodically check the shore power cord(s) for deterioration or damage.
- **NEVER** use damaged or faulty cords since the danger of fire and electrical shock exists.
- **DO NOT** pinch shore power cords in doors or hatches, or coil the shore power cord too tightly since these situations can generate enough heat to result in a fire.
- If a shore power cord accidentally becomes immersed in water, **THOROUGHLY** dry the blades and contact slots before reusing.

**CAUTION!*****ELECTRICAL SYSTEM DAMAGE HAZARD!***

- **NEVER** connect to dockside power outside of North America unless you have purchased the international electrical conversion option.
- Using several AC components at the same time can result in an overloaded circuit. You may have to turn *Off* one or more components in order to use another accessory.
- Use double insulated or three-wire protected electrical appliances whenever possible.

NOTICE

- Some dockside installations may be rated less than 30 amps, therefore, you may need to purchase lower amp adapters.
- Whenever a lower amp adapter is used, however, there *will* be a corresponding drop in supplied power from the dockside system.

- The single shore power 120V/60Hz, AC system (if equipped) features one, 120V/30 amp, shore power receptacle.
- If your boat is equipped with an air conditioning system, a second (dual) 30 amp inlet has been installed.
- The dual shore power inlets are labeled "LINE 1" and "LINE 2", which corresponds to the "LINE 1" and "LINE 2" master breakers on the AC panel.
- The dual shore power system is designed so that each line is independent of the other except when the AC power transfer switch is used.

1. Review **all** hazard information at the beginning of this section, *Shore Power*.
2. Turn **Off all** breakers and switches on the AC master panel.
3. Attach the shore power cord to the boat inlet first then to the dockside outlet.
4. Monitor the AC panel's polarity indicator lights, located below the line master breaker(s), as follows:
 - A **green** light illuminating after the power cord is plugged into the dockside outlet indicates acceptable electrical power. You may turn **On** the master breaker switch.
 - A **red** light, however, indicates reversed polarity, which could cause electrical system damage and possibly electrical shock injuries. In this case, **do not** turn **On** the master breaker switch.
5. Switch the "LINE 1 DOCKSIDE MASTER" **On**.
6. If equipped with dual dockside, switch the "LINE 2 DOCKSIDE MASTER" **On**.
7. Turn **On** the individual component breakers as required.

Transfer Switch (If Equipped with Dual Shore Power)

NOTICE

- **When using the "Transfer Switch" do not exceed 30 total amps.**
- **The amperage of each component breaker is shown in figure 1.**
- **The voltage on each line can be read by setting the voltmeter selector switch.**

When only one dockside outlet is available, you can use the "Transfer Switch" to provide power to both lines.

1. Connect to shore power as described in steps 1 through 4 above.
2. Switch the "LINE 1 TRANSFER SWITCH" (transfers power from line 1 to line 2) **On** instead of the "LINE 2 DOCKSIDE MASTER.
3. Turn **On** the individual component breakers as required.

Electrical Routings

Hull Electrical Harness

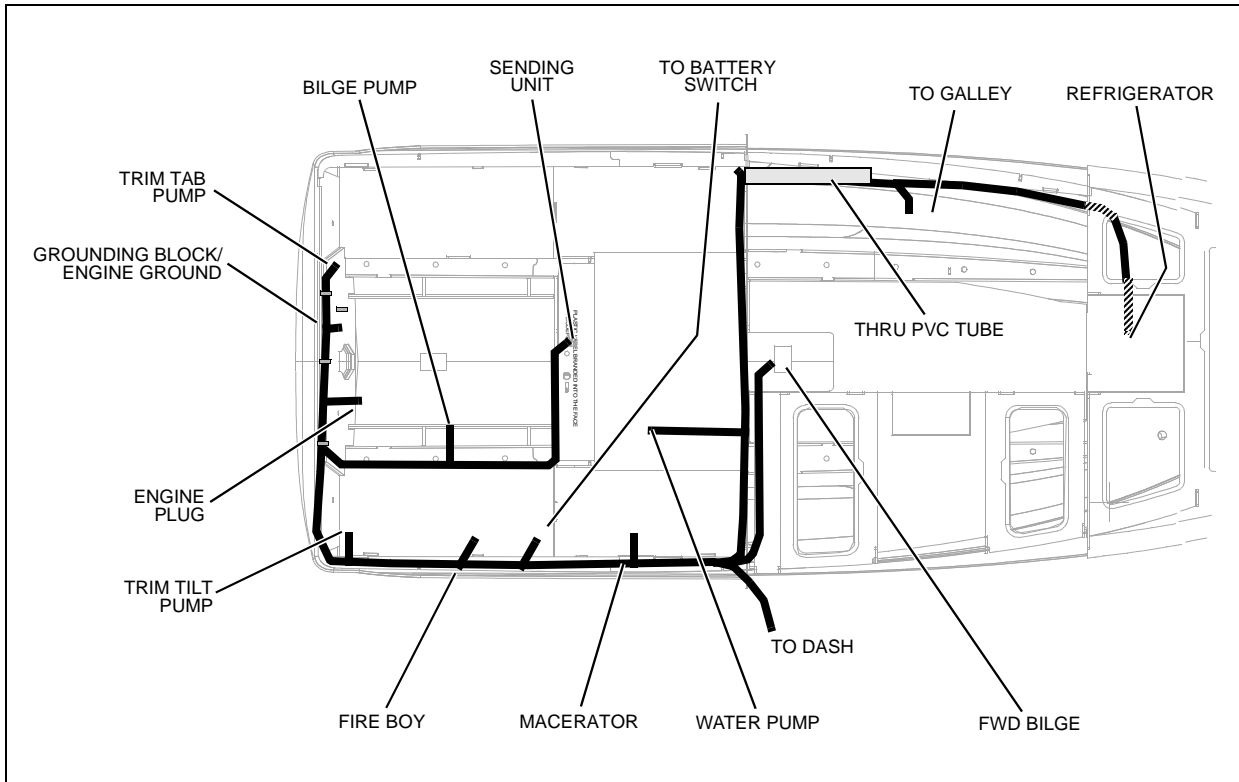

Deck Electrical Harness.

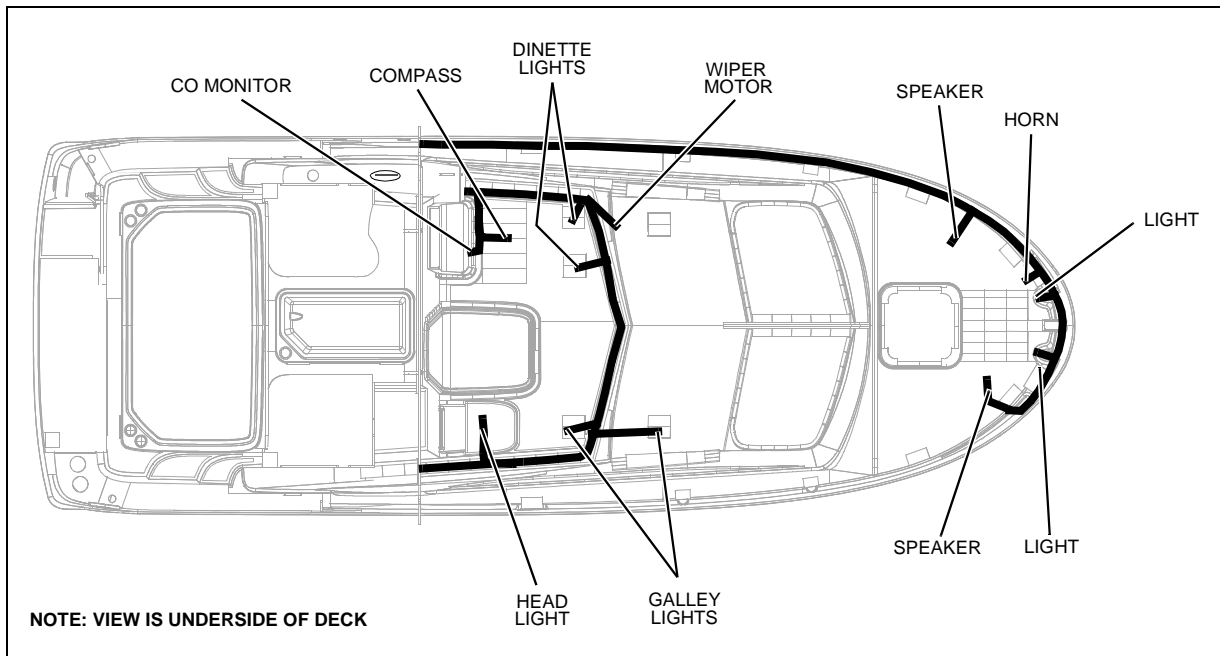

120 Volt AC System (If Equipped)

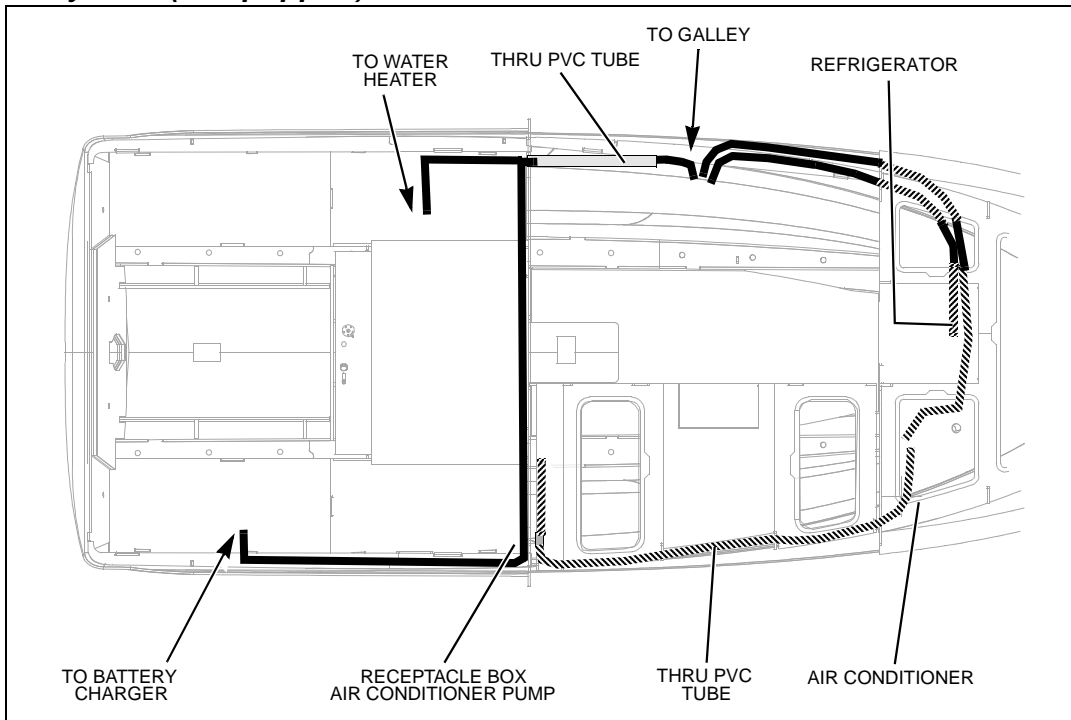

Battery System

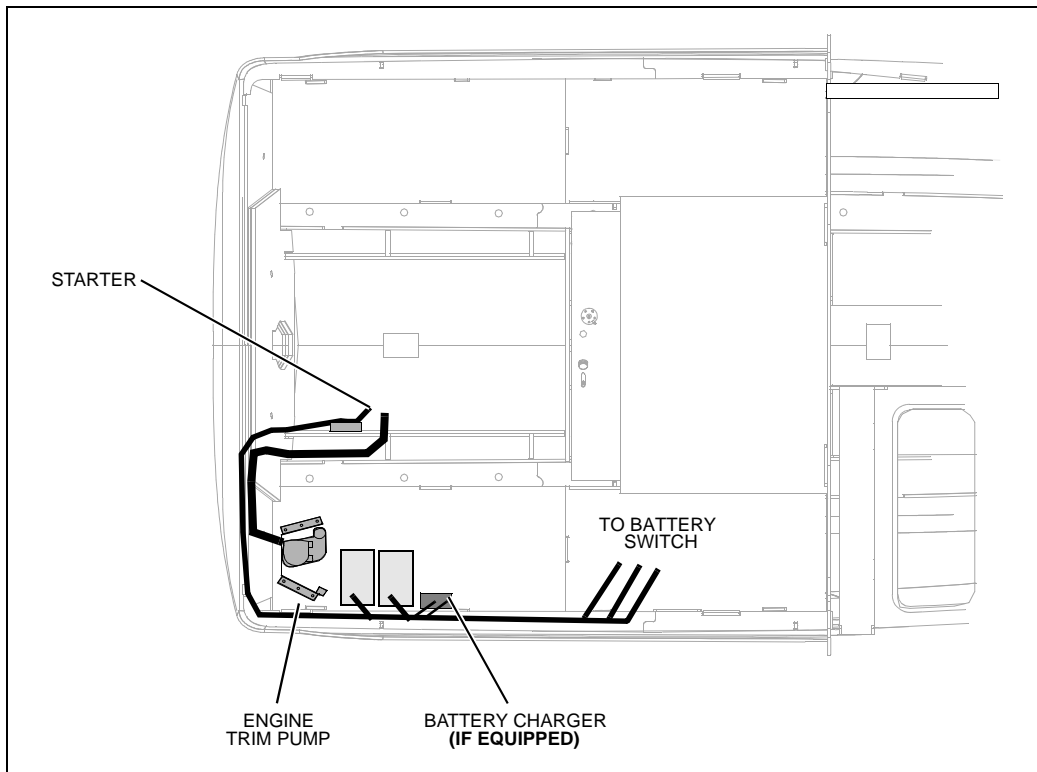

Bonding Harness

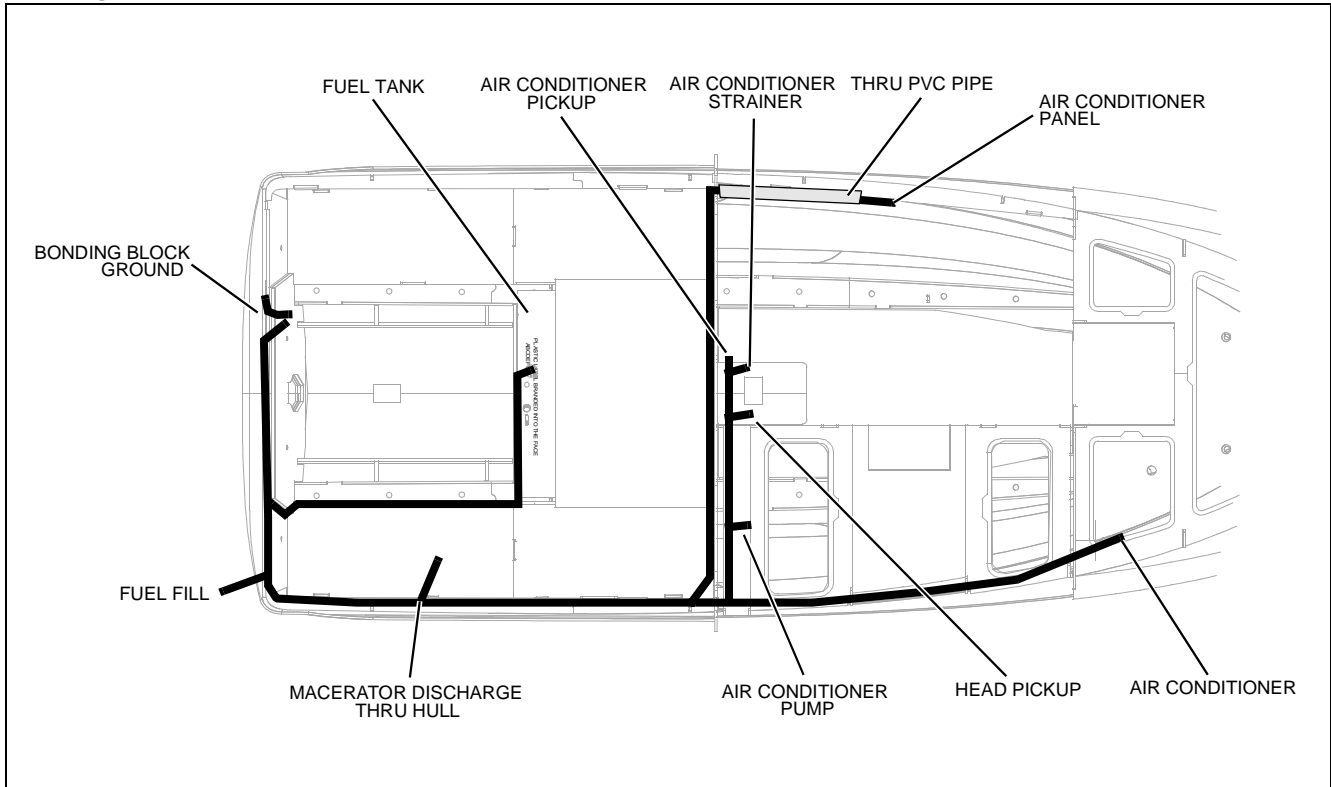

Wire Diagrams

Engine Electrical System

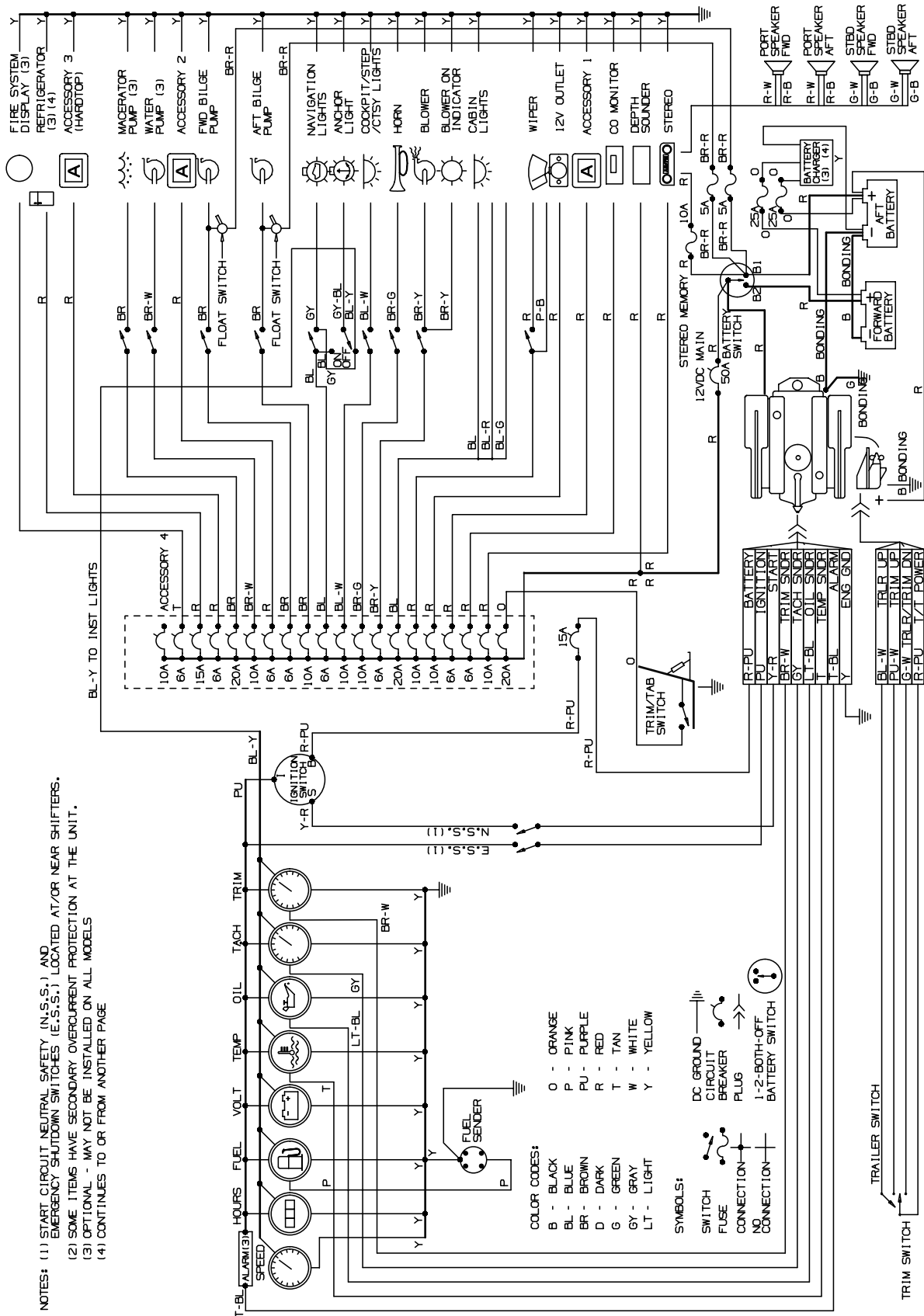

Single Dockside

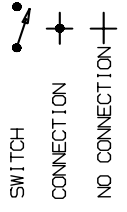
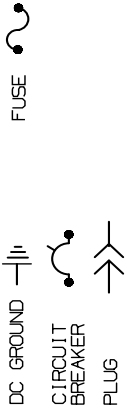

Y - YELLOW
LT - LIGHT
DK - DARK

PU - PURPLE
R - RED
T - TAN
W - WHITE

COLOR CODES:
B - BLACK
BL - BLUE
G - GREEN
O - ORANGE

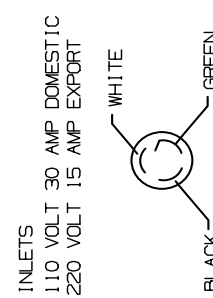

- REFERENCES:
- (1) CONTINUES TO OR FROM ANOTHER PAGE.
 - (2) EXPORT OPTION ONLY.
 - (3) OPTIONAL EQUIPMENT ON SOME MODELS.
 - (4) GREEN GROUNDING CONDUCTORS FROM LINE APPLIANCES CONNECT TO AC GROUND BUSS. (5) WHITE NEUTRAL CONDUCTORS FROM LINE APPLIANCES CONNECT TO NEUTRAL BUSS.
 - (6) LINE MASTER BREAKER SIZES:
110 STANDARD - 30A
220 STANDARD - 15A

Dual Dockside

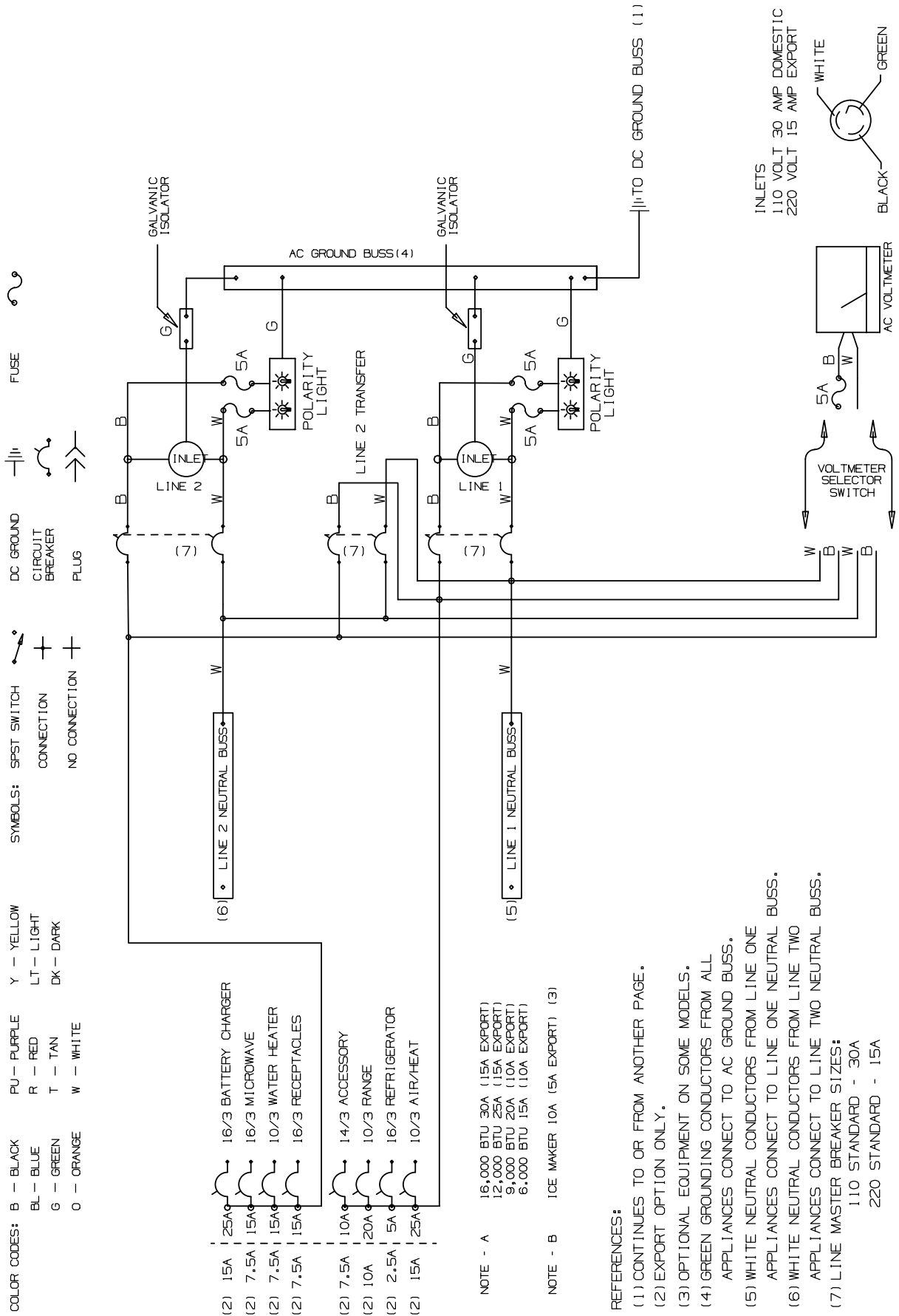

Important Records

Selling Dealer

Name Of Dealership

Address

Phone/FAX/E-mail

Sales Manager

Service Manager

Engine

Manufacturer

Model Name/Number

Engine Serial Number

Oil Type/SAE

Quarts per Engine

Filter Type

Propeller

Manufacturer

Pitch

Model Number

Key Numbers

Ignition

Other

Electronics

Manufacturer

Model Name/Number

Serial Number

Manufacturer

Model Name/Number

Serial Number

Manufacturer

Model Name/Number

Serial Number

Manufacturer

Model Name/Number

Serial Number

Float Plan

Before going boating, fill out a copy of this float plan (or similar) and leave it with a **reliable** person whom you can depend on to contact the Coast Guard or other rescue organization, if you do not return as scheduled.

Description of Boat

Registration/Documentation Number		
Length	Make	Type
Hull Color		Trim Color
Fuel Capacity	Engine Type	Number of Engines
Distinguishing Features		
Distinguishing Features		

Operator of Boat

Full Name		
Male or Female	Age	Health
Address		
Address		
Phone/FAX/E-mail		
Operator's Experience		

Persons on Board

Full Name		
Age	Health	Phone Number
Full Name		
Age	Health	Phone Number
Full Name		
Age	Health	Phone Number
Full Name		
Age	Health	Phone Number
Full Name		
Age	Health	Phone Number
Full Name		
Age	Health	Phone Number

Survival Equipment

Marine Radio (Yes/No)	Type	Frequencies
Number of PFDs	Flares (Yes/No)	Mirror (yes or no)
Smoke Signals (Yes/No)	Flashlight (Yes/No)	Food (Yes/No)
Water (Yes/No)	Anchor (Yes/No)	Raft/Dinghy (Yes/No)
Paddles (Yes/No)	EPIRB (Yes/No)	Other
Other	Other	Other

Vehicle Description

Make	Model
Color	License Number
Where is the Vehicle Parked?	

Trip Expectations

Departing From	
Departure Date	Departure Time
Stopover 1	
Arrive No Later Than: Date	Arrive No Later Than: Time
Stopover 2	
Arrive No Later Than: Date	Arrive No Later Than: Time
Stopover 3	
Arrive No Later Than: Date	Arrive No Later Than: Time
Stopover 4	
Arrive No Later Than: Date	Arrive No Later Than: Time
Stopover 5	
Arrive No Later Than: Date	Arrive No Later Than: Time
Stopover 6	
Arrive No Later Than: Date	Arrive No Later Than: Time
Final Destination Port (If Different Than Home Port)	
Arrive No Later Than: Date	Arrive No Later Than: Time

If not returned by the date and time listed above, call the Coast Guard or other local authority.

Coast Guard Phone Number

Local Authority Phone Number

Part Number 1718021

Bayliner • P.O. Box 9029 • Everett, WA 98206 • 360-435-5571