

# BAYLINER®

*5288 Pilothouse  
Motoryacht*

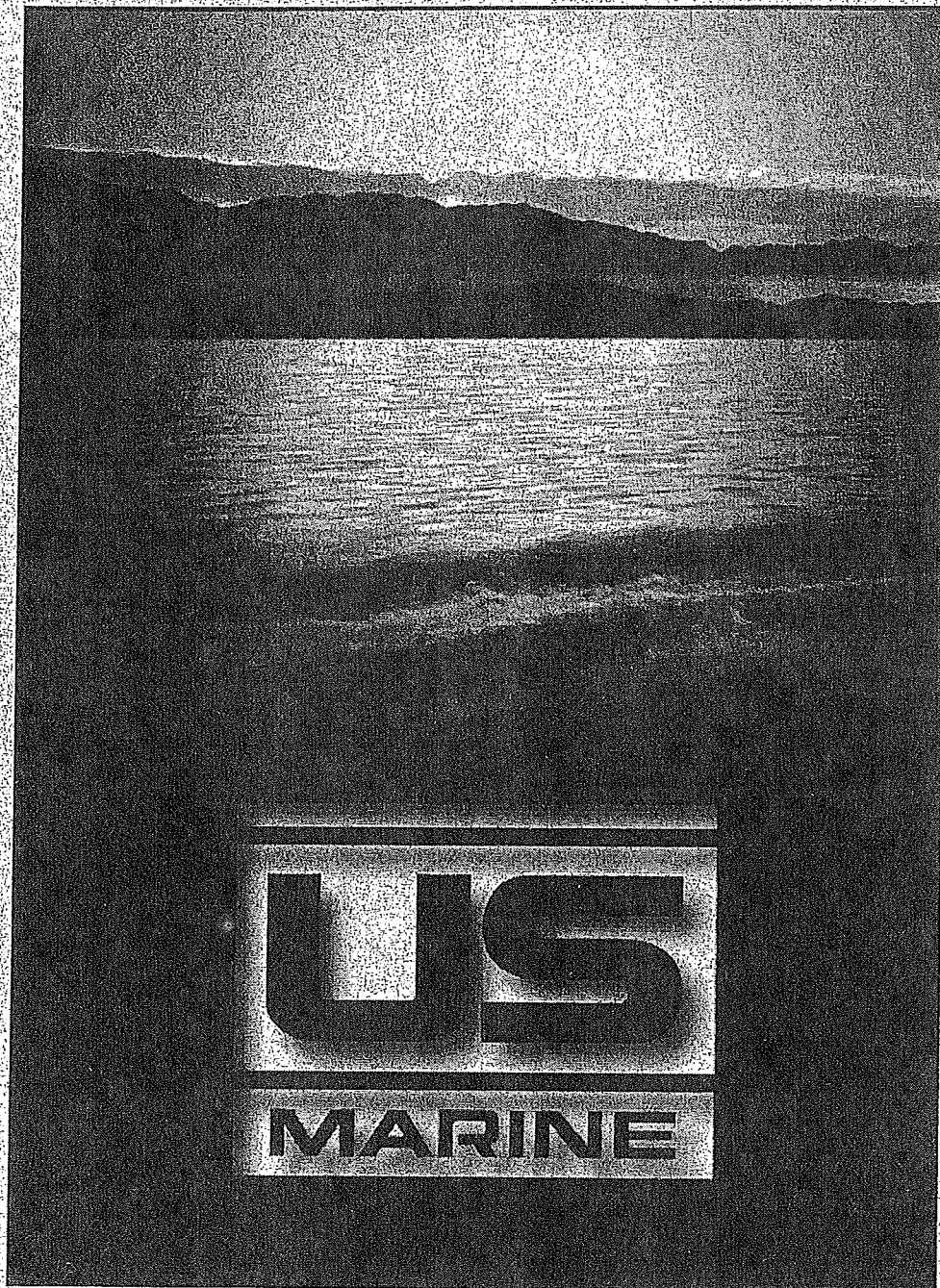

*Owner's Manual Supplement*



## To Be The Best For Total Customer Satisfaction

---

**Congratulations and welcome aboard your new Bayliner Motoryacht!**

Thank you for choosing our product. Bayliner, a division of US Marine, is committed to the goal of building the highest quality products in the marine industry and to providing the finest after-the-sale support in the world.

To keep our respected status as the number one boat builder in the world, US Marine has instituted an ongoing **Total Customer Satisfaction Program**. The guiding principles of this program are:

- Design, build and support the finest marine products in the world, in every market we serve.
- Be personally and individually responsible for the customer's total satisfaction.
- Remember that every customer has a choice, and we want them to choose US Marine!

**Welcome to the US Marine family. We are looking forward to serving your boating needs, now and in the future!**

**BAYLINER** *A division of US Marine, a Brunswick Company*

Hull Identification Number: \_\_\_\_\_

Port Engine Serial Number: \_\_\_\_\_

Stbd. Engine Serial Number: \_\_\_\_\_

### **Hull Identification Number**

The Hull Identification Number (HIN) is located on the starboard side of the transom.

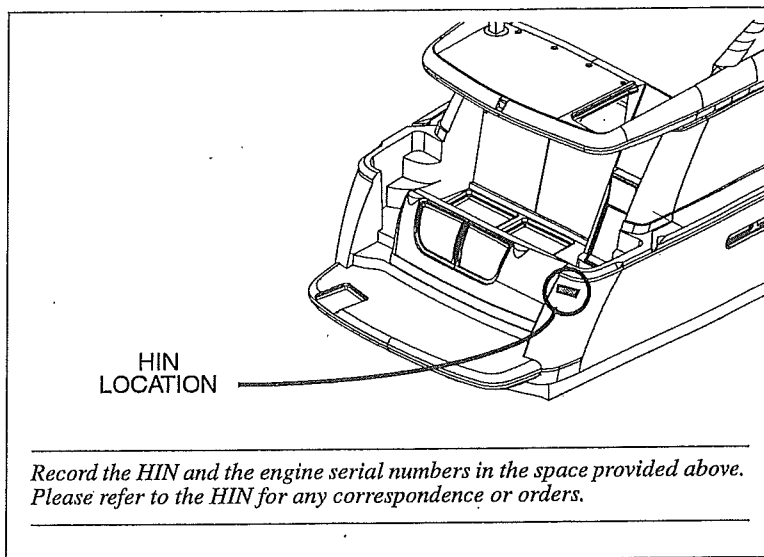

© 1998 Bayliner Technical Publications. All rights reserved.

No part of this publication may be reproduced, stored in any retrieval system, or transmitted in any form by any means, electronic, mechanical, photocopying, recording or otherwise, without prior written permission of Bayliner. Printed in the United States of America.

#### **General Notes**

The material in this document is for information only and is subject to change without notice. While reasonable efforts have been made in the preparation of this document to assure its accuracy, Bayliner assumes no liability resulting from errors or omissions in this document, or from the use of information contained herein.

Due to our commitment to product improvement, Bayliner reserves the right to make changes in the product design, specifications, and equipment at any time without notice or obligation. Illustrations and/or photos may show optional equipment.

All Bayliner products meet or exceed USCG and/or NMMA construction standards. Manufactured with 1,1,1 Trichloroethane, a substance which harms public health and environment during the manufacturing process by destroying ozone in the upper atmosphere.

#### **Proprietary Rights**

This document discloses subject matter in which Bayliner has proprietary rights. The information and design disclosed herein were originated by and are the property of Bayliner. Neither receipt nor possession thereof confers or transfers any right to reproduce, copy, alter or disclose the document or any part thereof, any information contained therein, or to construct boats or any item from it, except by written permission from or written agreement with Bayliner. This document is to be returned upon request to Bayliner.

# CONTENTS

---

## CHAPTER 1: ABOUT THIS MANUAL

- 1 Dealer Service
- 1 Boating Experience
- 1 Engines/Accessories Guidelines
- 1 Structural Limitations
- 1 Safety Standards
- 2 Qualified Maintenance
- 2 Hazard Warning Symbols

## CHAPTER 2: COMPONENTS / SYSTEMS

- 3 Dimensions & Tank Capacities
- 3 Hull Exterior Hardware
- 4 Lifting Sling Locations
- 4 Deck Fill & Pump-out Locations
- 5 Deck Equipment
  - 5 *Windshield Wipers*
  - 5 *Anchor Windlass*
  - 5 *Davit*
- 6 Instruments
  - 6 *Pilothouse Helm*
  - 7 *Command Bridge Helm*
- 7 Audio & Visual Equipment
- 7 Navigation & Communication Equipment
  - 7 *Depth Finder (Option)*
  - 8 *Compass*
  - 8 *Autopilot (Option)*
  - 8 *Radar (Option)*
  - 8 *VHF Radio (Option)*
- 8 Dockside Television & Telephone Inlet
  - 8 *Television & TV Routing*
- 9 Appliances
- 9 Lights
  - 9 *Navigation & Interior Lights*
  - 9 *Spotlight*
- 10 Salon Table Conversion
- 10 Propulsion
  - 10 *Engines*
  - 10 *Engine Room Ventilation System*
  - 11 *Engine Cooling System*
  - 11 *Exhaust System*
  - 12 *Shaft-Transmission Alignment*
  - 12 *Shaft Log Packless Sealing System*

- 12 Oil Change System (Option)
- 13 Fire Extinguishing System (Option)
- 13 Controls
  - 13 *Steering & Shift/Throttle System*
  - 13 *Steering & Shift/Throttle Routing*
  - 14 *Shifter/Throttle Reservoir Routing*
  - 14 *Trim Tabs*
  - 15 *Bow Thruster*
  - 15 *Rudder Stuffing Gland*
- 15 Bilge
  - 15 *Bilge Pumps*
  - 17 *Autofloat Switches*
- 17 Fuel System
  - 17 *Fuel Fills & Vents*
  - 18 *Fuel Tank Routing*
  - 18 *Fuel Quality*
  - 18 *Fuel Transfer Pump*
  - 19 *Fuel System Routing*
  - 19 *Fuel Filters & Separators*
- 20 Freshwater System
  - 20 *Water Heater*
  - 21 *Shower Sump Pump*
  - 21 *Hot & Cold Water Routing*
  - 22 *Freshwater Washdown*
- 22 Seawater System
  - 22 *Seawater Strainers*
  - 23 *Water Maker (Option)*
  - 23 *Raw Water Washdown*
- 23 Air Conditioner & Heater (Option)
- 25 Diesel Heater & Defroster (Option)
- 26 Marine Head System with Holding Tank
- 26 Vacuum System
- 27 Electrical System
- 28 DC Electrical System
  - 28 *Circuit Breakers*
  - 28 *Batteries*
  - 28 *Battery Maintenance*
  - 28 *Battery Monitor Selector*
  - 28 *Battery Switches*
  - 28 *Battery Charger*
  - 28 *Engine Alternators*
- 29 AC Electrical System
  - 29 *Shore Power*
  - 31 *Inverter Power (Option)*
  - 31 *Generator Power*
  - 32 *Main Generator*
  - 33 *Auxiliary Generator (Option)*

---

**34 Electrical Routing**

- 34 Routing Key*
- 34 Drawing 1: Bonding Harness*
- 35 Drawing 2: Battery Cable Routing*
- 35 Drawing 3: Engine Harness*
- 36 Drawing 4: Aft Engine Room Bulkhead*
- 36 Drawing 5: Main Generator Harness*
- 37 Drawing 6: Hull Harness*
- 37 Drawing 7: Diesel Heater Harness (Option)*
- 38 Drawing 8: Winch Harness*
- 38 Drawing 9: Deck Harness*

**39 Wiring Schematics**

- 39 Electrical Symbol Key*
- 39 Wire Color Key*
- 40 Engine Harness*
- 41 Hull Harness*
- 42 Dockside AC Harness*
- 43 Pilothouse Harness*
- 44 Pilothouse Connector*
- 44 Salon Harness*
- 44 Arch Harness*
- 45 V-Berth Harness*
- 45 Diesel Heater (Option)*
- 45 Command Bridge Harness*
- 45 Generator Harness*

**APPENDIX A: ISO SYMBOLS**

**APPENDIX B: LIMITED WARRANTY**

## CHAPTER 1: ABOUT THIS MANUAL

This Owner's Manual Supplement was prepared to provide specific information about your yacht. Please study this supplement and the Owner's Manual carefully, paying particular attention to the LIMITED WARRANTY section. Keep this supplement in a secure, yet readily available place.

### Dealer Service

Make certain that you receive a full explanation of all systems from the selling dealer before taking delivery of your yacht. Your selling dealer is your key to service. If you experience any problems with your new yacht, immediately contact the selling dealer. If for any reason your selling dealer is unable to help, you can call us direct on our customer service hotline: 360-435-8957 or send us a FAX: 360-403-4235

### Boating Experience

If this is your first boat or if you are changing to a type of boat you are not familiar with, for your own comfort and safety, please ensure that you obtain handling and operating experience before assuming command of the yacht.

We strongly recommend that you take one of the boating safety classes offered by the U.S. Power Squadrons or the U.S. Coast Guard Auxiliary. For more course information, including dates and locations of upcoming classes, contact the organizations directly:

- U.S. Power Squadrons: 1-888-FOR-USPS (1-888-367-8777) or on the web at: <http://www.usps.org>
- U.S. Coast Guard Auxiliary: 1-800-368-5647 or on the web at: <http://www.cgaux.org>

Outside the United States, your selling dealer, national sailing federation or local yacht club can advise you of local sea schools or competent instructors.

### **WARNING!**

**CONTROL HAZARD!** A qualified operator must be in control of the yacht at all times. *Do not* operate your yacht while under the influence of alcohol or drugs.

### Engines/Accessories Guidelines

Your yacht's engines and accessories were selected to provide optimum performance and service. Installing different engines or other accessories may cause unwanted handling characteristics. Should you choose to install different engines or to add accessories that will affect the boat's running trim, have an experienced marine technician perform a safety inspection and handling test before operating your yacht again.

The engines and accessories installed on your yacht come with their own operation and maintenance manuals. We strongly urge you to read and understand these manuals before operating the engines/accessories.

### Structural Limitations

The command bridge, transom platform and bow platform are designed to be lightweight for proper boat balance. The load limit for these platforms and the command bridge is 30 pounds per square foot, evenly distributed.

### Safety Standards

Your yacht's mechanical and electrical systems were designed to meet safety standards in effect at the time it was built. Some of these standards were mandated by law. All of them were designed to insure your safety, and the safety of other people, vessels and property.

Please read the Owner's Manual for important safety standards and hazard information.

### **DANGER!**



**PERSONAL SAFETY HAZARD!** *Do not* allow anyone to ride on parts of the yacht not designated for such use. Sitting on seat backs, lounging on the forward deck, bow riding, gunwale riding or occupying transom platform while underway is especially hazardous and will cause personal injury or death.

## Qualified Maintenance

### **WARNING!**

To maintain the integrity and safety of your yacht, only qualified personnel should perform maintenance on, or in any way modify: The steering system, propulsion system, engine control system, fuel system, environmental control system, electrical system or navigational system.

Failure to maintain these systems (listed in the warning above) as designed could violate the laws in your jurisdiction and could expose you and other people to the danger of bodily injury or accidental death. We recommend that you follow the instructions provided in this supplement, the Owner's Manual, the engine owner's manual and the accessory instruction sheets included with your boat.

## Hazard Warning Symbols

The hazard warning symbols shown below are used throughout this supplement to call attention to potentially dangerous situations which could lead to either personal injury or product damage. We urge you to read these warnings carefully and follow all safety recommendations.

### **DANGER!**

This symbol alerts you to immediate hazards which WILL cause severe personal injury or death if the warning is ignored.

### **WARNING!**

This symbol alerts you to hazards or unsafe practices which COULD result in severe personal injury or death if the warning is ignored.

### **CAUTION!**

This symbol alerts you to hazards or unsafe practices which COULD result in minor personal injury or cause product or property damage if the warning is ignored.

### **NOTICE**

This symbol calls attention to installation, operation or maintenance information, which is important to proper operation but is not hazard-related.



**Fire and/or  
Explosion Hazard!**



**Open Flame  
Hazard!**



**Rotating Propeller  
Hazard!**



**Personal Injury &  
Falling Hazard!**

## CHAPTER 2: COMPONENTS / SYSTEMS

### Dimensions & Tank Capacities

Overall Length	Bridge Clearance	Beam	Draft	Fuel Capacity (gal)	Freshwater Capacity (gal)	Holding Tank Capacity (gal)
56' 0"	19' 3"	16' 1"	4' 7"	700	200	76

### Hull Exterior Hardware

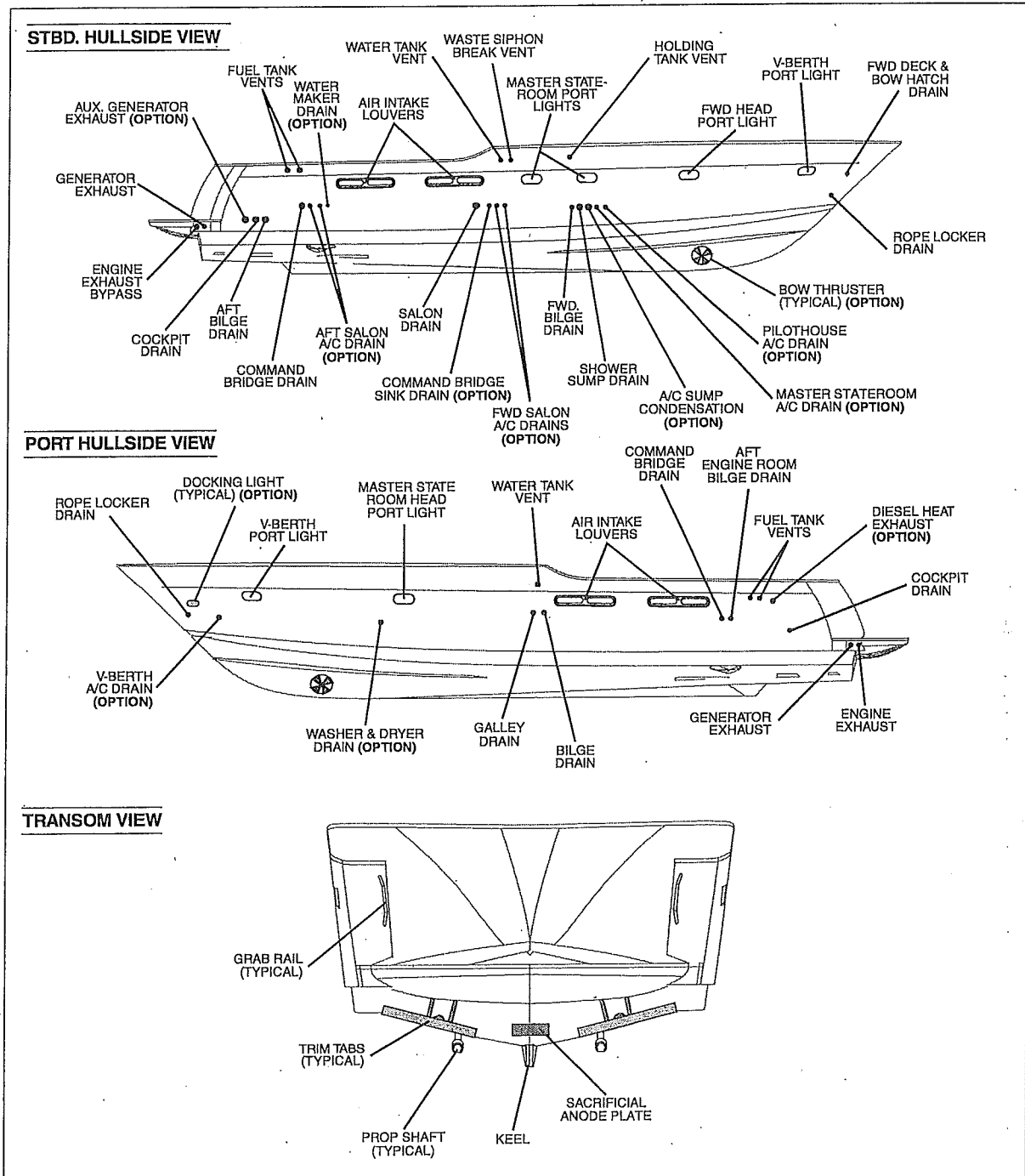



### Lifting Sling Locations

Use the following lifting sling locations when raising or lowering your yacht in and out of the water:

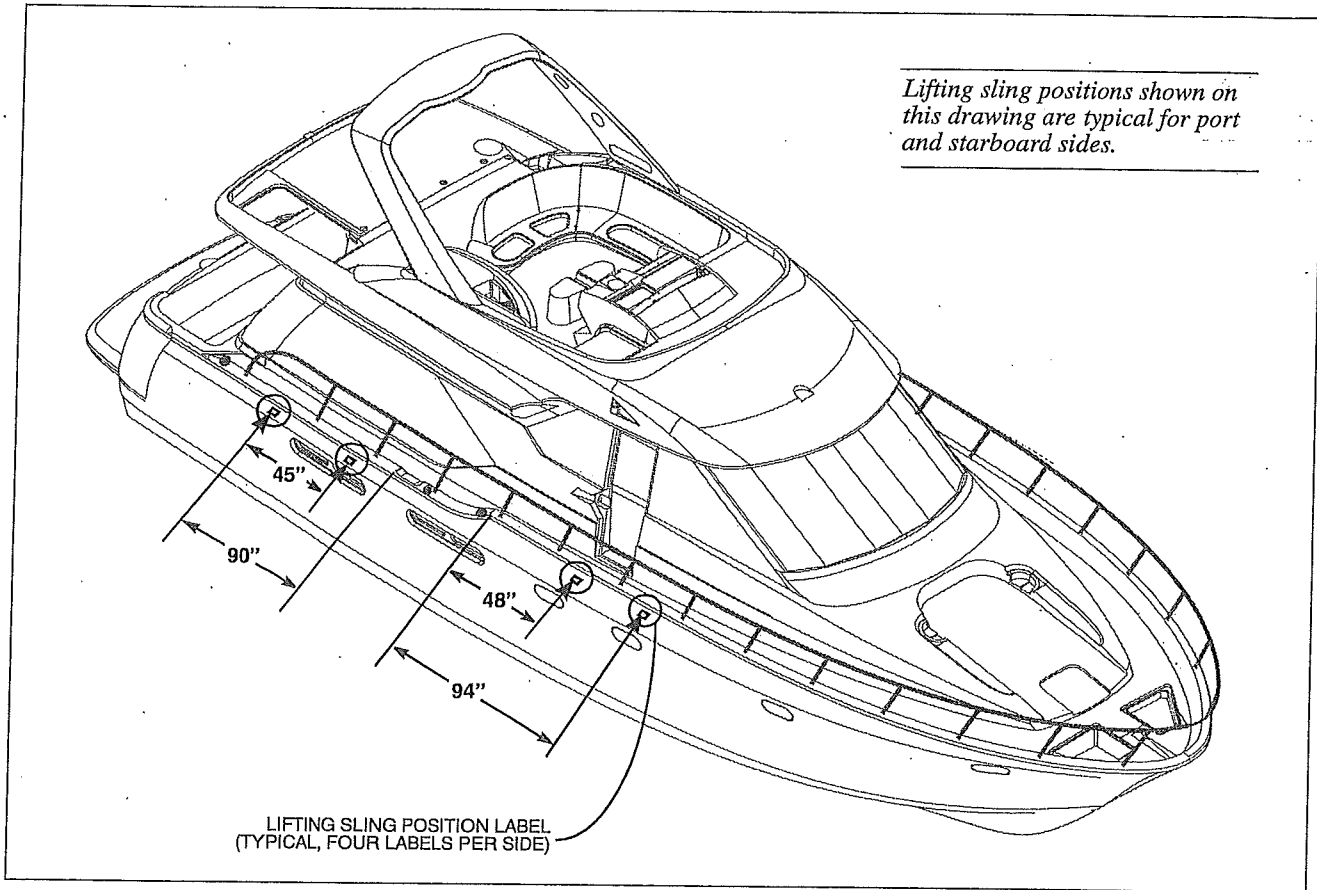

### Deck Fill & Pump-out Locations

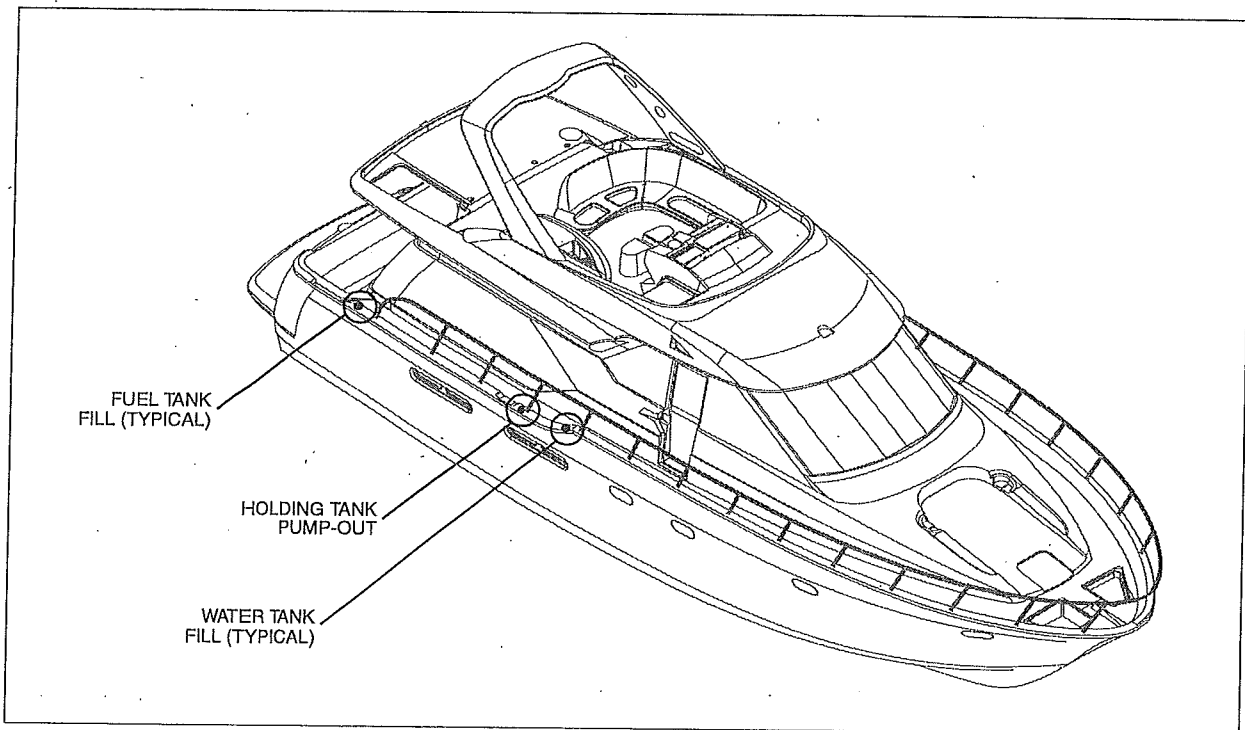

## Deck Equipment

### Windshield Wipers

- Windshield wiper and washer switches are located on the pilothouse helm's upper accessory panel.
- Periodically, due to wear and environmental exposure, you will need to replace wiper blades using 28" blade refills. Instructions for replacing the wipers can be found on the wiper replacement package.
- The windshield wiper fluid level should be checked occasionally and refilled as necessary. The windshield wiper fluid bottle is located in the pilothouse and can be accessed from underneath the port forward L-shaped lounge.

### Anchor Windlass

Before using the anchor windlass, read the windlass manual included in your yacht's owner's packet and observe the following:

- To haul the anchor, use engine power (*not* the windlass) to move the boat to, and directly over the anchor.
- Disengage the anchor from the bottom by pulling it *straight up* with the windlass. *Do not* pull the boat to the anchor using the windlass or continue to operate the anchor windlass if it stalls or is overloaded.

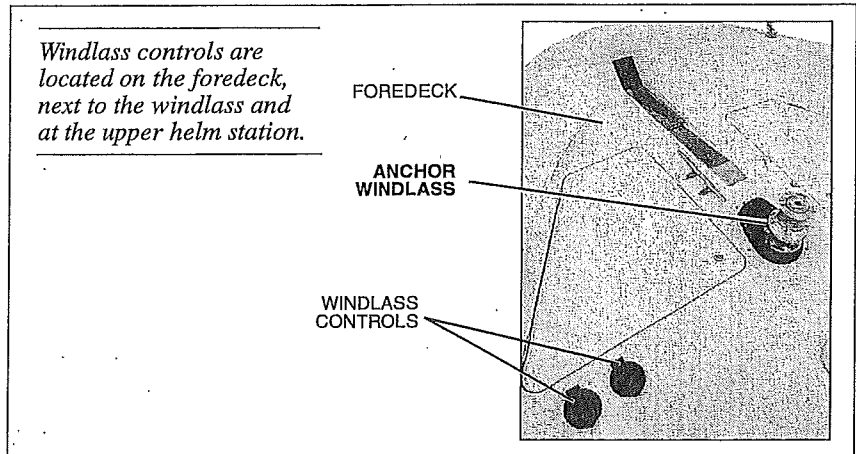

### Davit

Your yacht is equipped with a standard-equipped manual davit (winch) or an **optional** hydraulic davit. Please read the davit's manual which explains detailed operating instructions and safety hazards. The davit controls are typically located on the back side of the davit, just above the davit base.

Observe the following:

- Inspect the davit's cable often for wear and replace if frayed.
- The cable should be kept tight and even on the spool and when under tension during winch operation.
- Disconnect the davit's cables from the quick-disconnect fittings (mounted on the bulkhead) when the davit is not in use.
- After lifting a load onto the yacht, remove the davit cables and secure the load to the deck.

**WARNING!**

**FALLING/PERSONAL INJURY HAZARD!**

- Do not allow passengers inside a suspended boat
- Falling from a suspended boat may cause injury or death
- Davit load not to exceed 1,000 lbs.
- Only operate the davit when it is securely locked in the upright position

DAVIT EYE

DAVIT (TYPICAL)

*Always secure the davit to the davit eye when the davit is not in use.*

**WARNING!**

- Since water is heavy, lifting the dinghy to drain its bilge may exceed the davit's load limit (1,000 lbs.)
- Use extreme care when using the davit in rough weather or rough sea conditions as the load may start swinging

# Instruments

## Pilothouse Helm

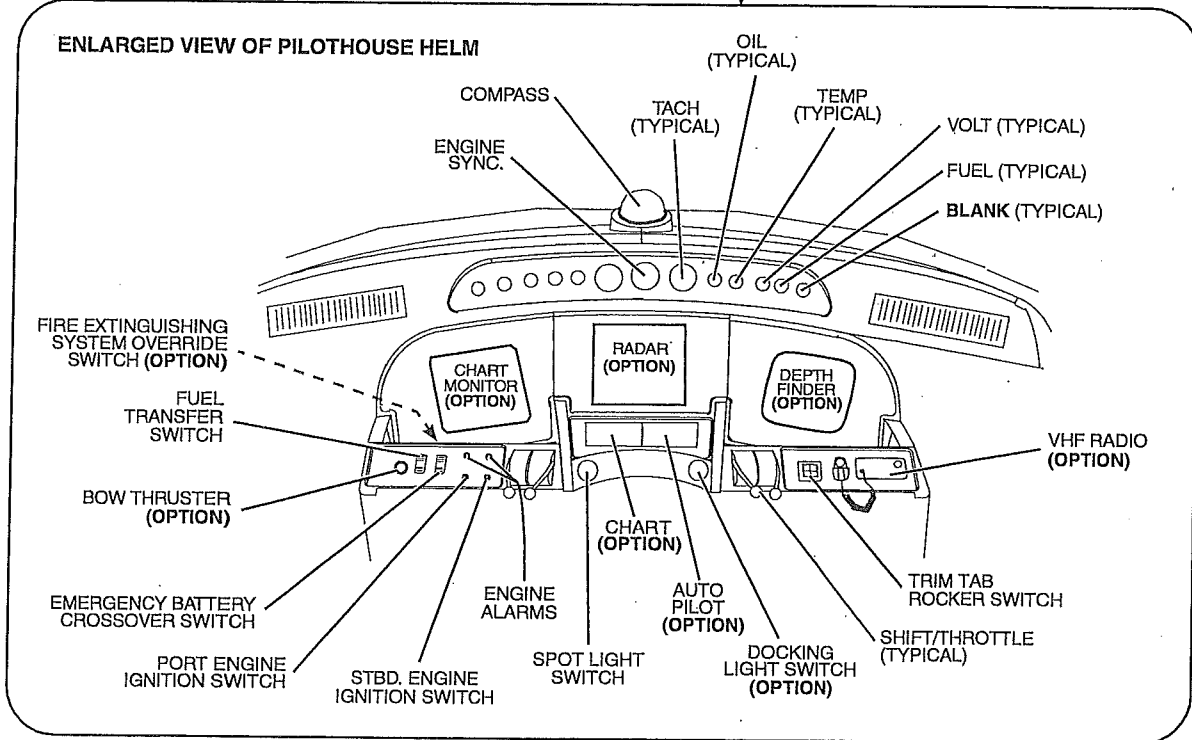
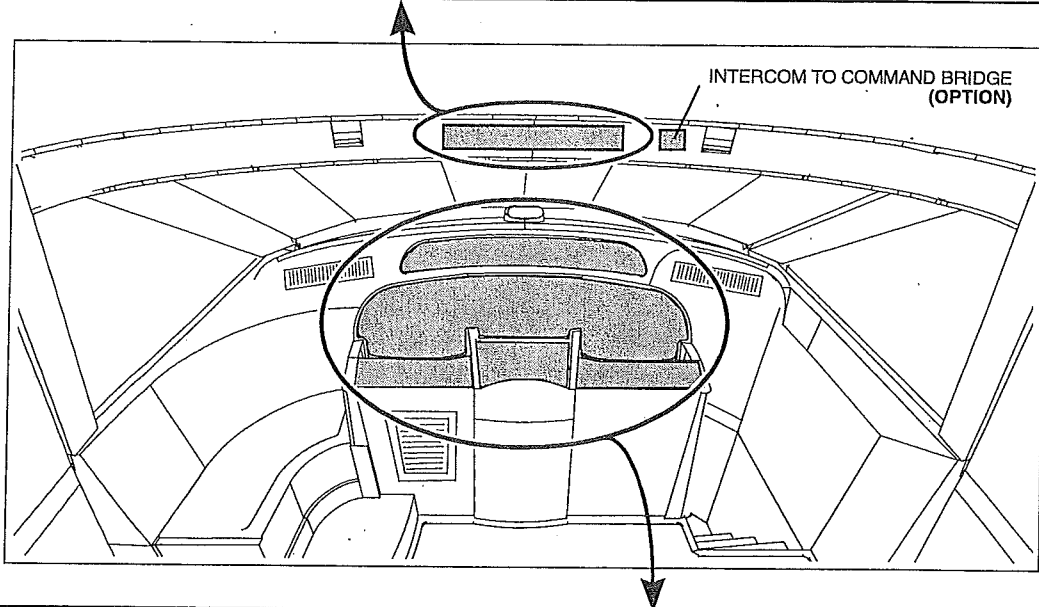
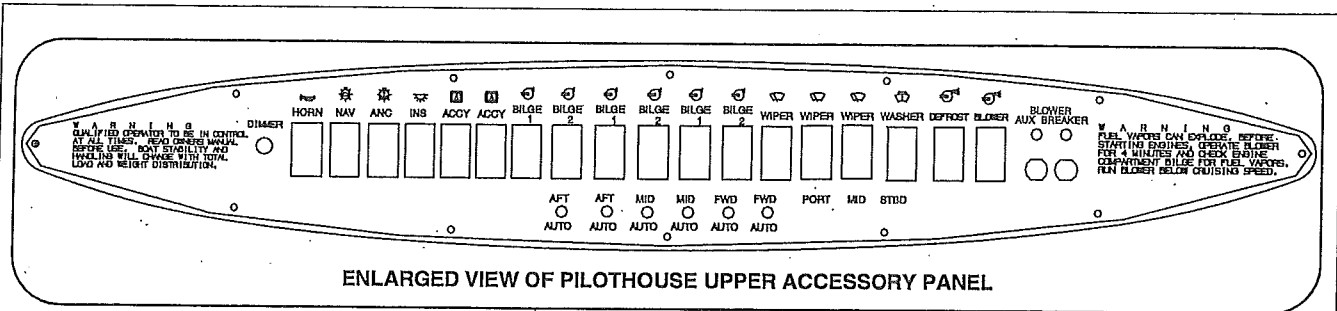

**Command Bridge Helm**

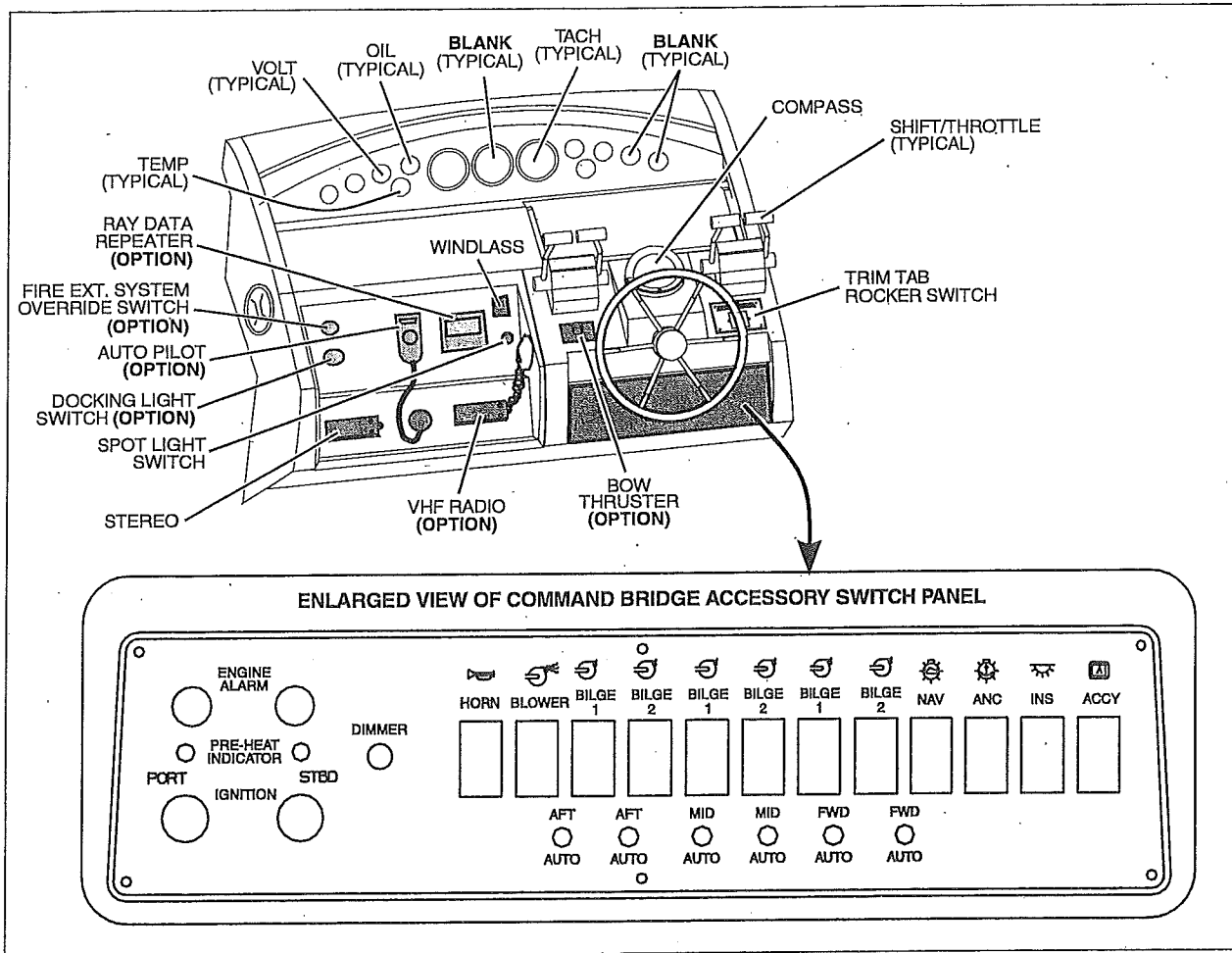

**Audio & Visual Equipment**

All audio and visual equipment installed on your yacht have separate manuals explaining their operating instructions.

**NOTICE**  
 AM radio reception may be impaired anytime the engines are running.

**Navigation & Communication Equipment**

The owner's packet contains operation manuals for all navigation & communication equipment installed on your yacht. We *strongly* recommend that you thoroughly read and understand these manuals before using these systems for the first time.

**Depth Finder (Option)**

Your motoryacht may feature an **optional** depth finder (depth sounder) at the pilothouse helm station. The depth finder will provide you with measurements of water depth beneath the boat.

**⚠ WARNING!**

**Do not use the depth finder as a navigational aid to prevent collision, grounding, boat damage or personal injury. When the boat is moving, submerged objects will not be seen until they are already under the boat. Bottom depths may change too quickly to allow time for the boat operator to react. If you suspect shallow water or submerged objects, operate the boat at very slow speeds.**

**Compass**

Your yacht is equipped with two compasses, one at each helm station. Carefully read and follow the manufacturer's calibration and operating instructions provided in the boat's owner's packet

**Autopilot (Option)**

Your yacht may feature an **optional** autopilot system which can be activated from either helm. The autopilot will aid you in maintaining the chosen heading of your yacht automatically.

**⚠ WARNING!**

*Never leave the helm while the autopilot system is on! Someone should always stay at the helm as a lookout in case a dangerous situation suddenly develops.*

**NOTICE**

**The autopilot system is only an aid to navigation. It's accuracy can be affected by many factors, including equipment failure or defects, environmental conditions & improper handling or use.**

**Radar (Option)**

Your yacht may be equipped with an **optional** marine radar system. Radar provides you with a complete and accurate 360° radar picture of other vessels, buoys, and landfall surrounding your vessel. Radar can be activated at the pilot-house helm station.

**VHF Radio (Option)**

Your yacht may include an **optional** VHF (Very High Frequency) radio. The VHF radio can be used to access weather reports, summon assistance or contact other vessels as permitted by the FCC (Federal Communications Commission). We urge you to contact the FCC for information on licensing, rules and regulations concerning VHF radio usage.

**Dockside Television & Telephone Inlet**

Your yacht is equipped with a dockside television and telephone inlet.

- The TV/telephone dockside inlet is located on the aft transom bulkhead, next to the shore power inlet.
- To use a telephone or receive television transmission, the yacht must be hooked up to a dockside source.

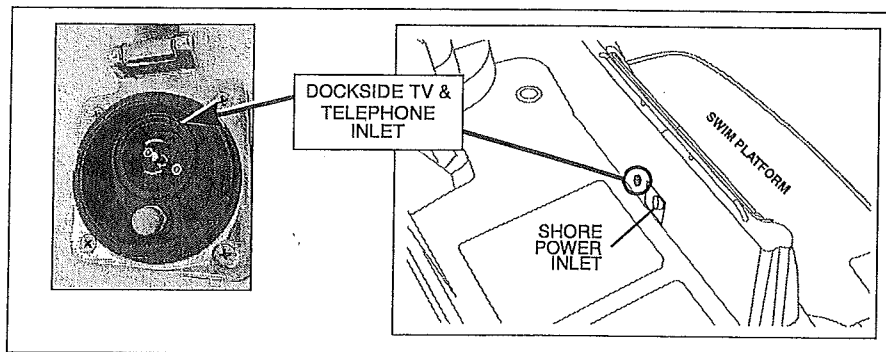

**Television & TV Routing**

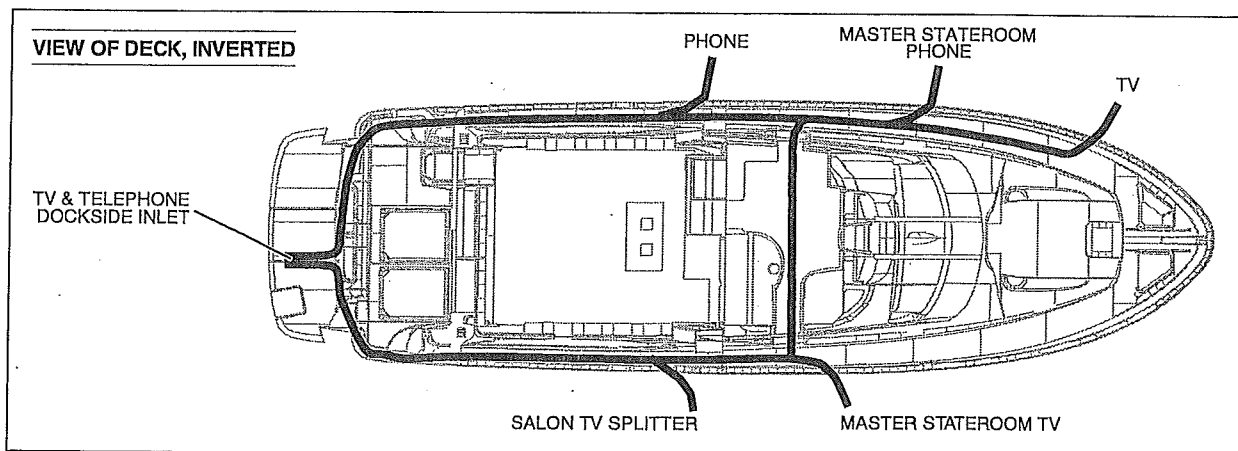

## Appliances

The owner's packet includes operating and maintenance manuals for all appliances installed in your yacht. Carefully read and understand these manuals before attempting to operate or perform maintenance on any appliance.

Appliances operate on 120v AC power, which may be supplied from shore power, generator power or inverter power (the inverter supplies power to the blender, ice maker, refrigerator and receptacles only). Make sure the AC breaker is activated for the appliance you wish to turn on.

### WARNING!

#### Electric Stove:

- **Do not touch stove burners, grates or areas near the stove units as they may be hot even when they are dark in color. Areas near burners and grates may become hot enough to cause burns.**
- **During and after use, do not touch or let clothing or other flammable material come in contact with heated units or areas near the units (burner tops, main frame sides and back, sea rails and pot holders) until they have had sufficient time to cool.**

## Lights

### Navigation & Interior Lights

We strongly recommend that you understand navigation light usage by reading the navigation section of the Owner's Manual. The navigation and interior lights supplied with your yacht are of top quality, but you should be aware that failure may periodically occur for a variety of reasons:

- There may be a blown fuse (Replace the fuse in the switch panel)
- The bulb may be burned out (Carry spare bulbs for replacement)
- The bulb base may be corroded (Clean the base and coat it with non-conductive electrical lubricant)
- A wire may be damaged or may have come loose (Repair as required)

### CAUTION!

- **Avoid the storage of gear where it would block navigation lights from view.**
- **Prolonged operation of cabin interior lights (overnight) will result in a drained battery. Be conservative in the use of battery power.**

### Spotlight

Your yacht is equipped with a spotlight, located on the command bridge of your yacht. The spotlight can be controlled from either helm station. Please read the operating instructions included in your yacht's owner's packet.

## Salon Table Conversion

To convert the salon table to a dinette table:

1. Remove the cushion from the salon table top (step 1).
2. Raise the salon table by pushing down on the salon table support beam lever (step 2) to the desired height.
3. Remove the dinette table halves from their protective pouches and slide them, one at a time, over the salon table until the seat brackets are fitted flush against the salon table top (step 3).
4. Push the dinette table halves together until the biscuit spines are joined (step 4).
5. Fasten the table latches to lock the table top in place (step 5).

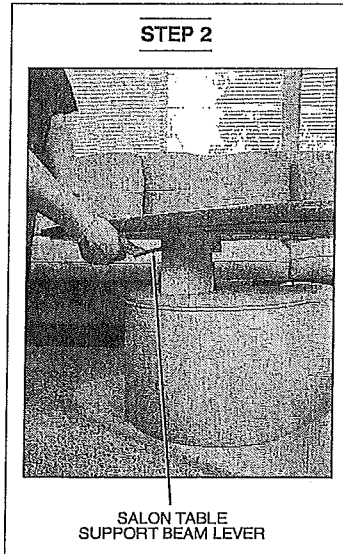
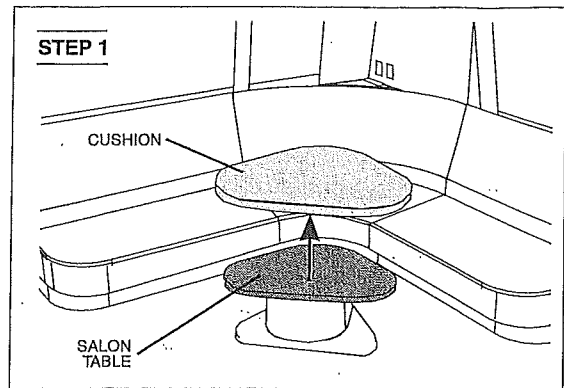

- To raise the salon/dinette table, push the support beam lever down until table is raised to the desired height.
- To lower the table, push downwards on the table top while depressing the support beam lever.

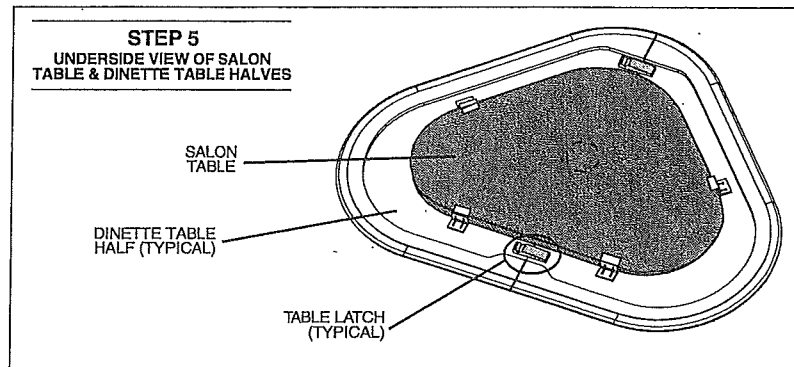
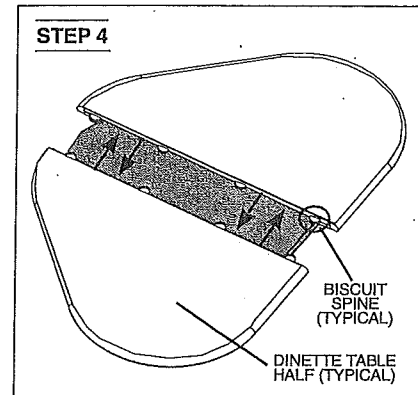
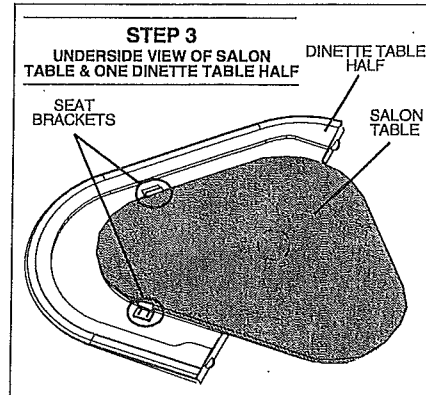

## Propulsion

### Engines

The owner's packet contains detailed engine operation and maintenance manuals. Read and understand these manuals *before* operating or performing maintenance to the engines.

### Engine Room Ventilation System

The bilge blowers remove fumes from the engine room and draws fresh air into the compartment through the deck vents. To ensure fresh air circulation, operate the bilge blowers for at least four minutes before starting the engines or generator(s) and while operating the yacht below cruising speed.

## ⚠ WARNING!



Operation of the blower system is not a guarantee that explosive fumes have been removed. If you smell any fuel, *do not* start the engines. If the engines are already running, immediately shut off the engines and all electrical accessories and investigate immediately. *Do not* obstruct or modify the ventilation system.

### Engine Cooling System

The engine cooling system circulates raw water around components and through a (freshwater) heat exchanger on the engine to reduce engine temperature.

- Make sure both engine seawater intake valves (seacocks) are *open* before starting the engines and keep the seacocks *open* while the engines are running.
- The cooling system's seawater strainers should be checked for leaks and debris every time you use your yacht. For instructions on how to clean the seawater strainers, see the *Seawater Strainer* section of this supplement.

**! CAUTION!**

**SYSTEM DAMAGE HAZARD!** The engine cooling system's seacocks must be *opened* before engines are started and during engine operation.

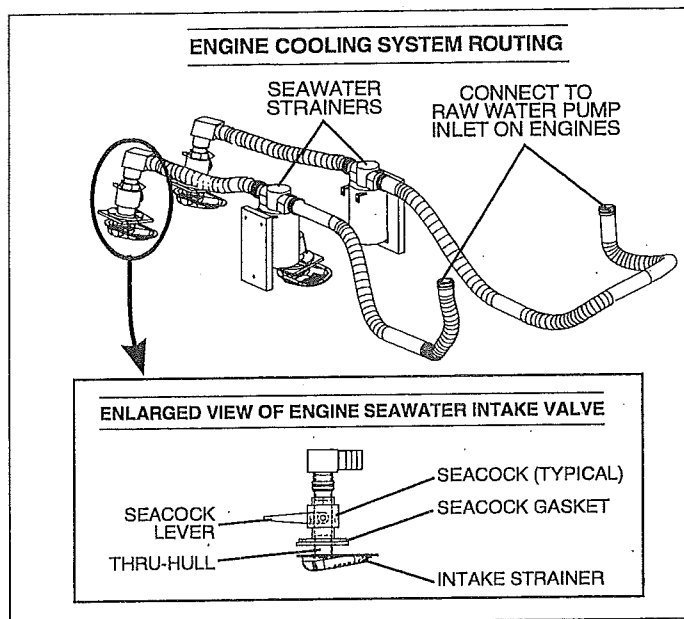

### Exhaust System

The exhaust system is designed to keep water out of the engines in most sea conditions, however, *do not* anchor stern to sea, and *do not* shut off the engines if the seas are too high. Check all of the hose clamps after the first 20 hours of engine operation and periodically after that.

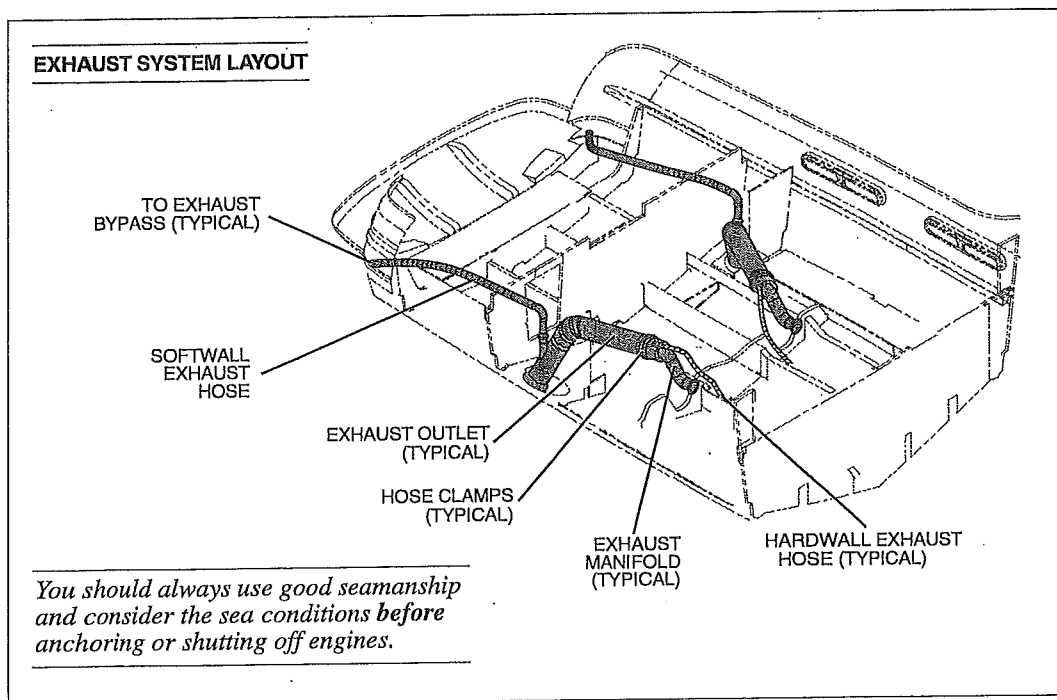



**Shaft-Transmission Alignment**

Alignment between the engine transmission output shaft and the propeller is very critical. The alignment has been performed at the factory and was rechecked by the dealer after the boat had been in the water for 48 hours.

- Shaft-transmission alignment should be performed by a marine mechanic since it requires moving the engine and prop shaft.
- An alignment inspection should be performed by a marine mechanic as part of the routine maintenance program after the initial 30 hours of operation, then every 60 hours and whenever unusual noise or vibration is noticed.
- To insure proper alignment after a haulout or dry storage, wait 48 hours after launching before final alignment adjustments by a marine mechanic are made.

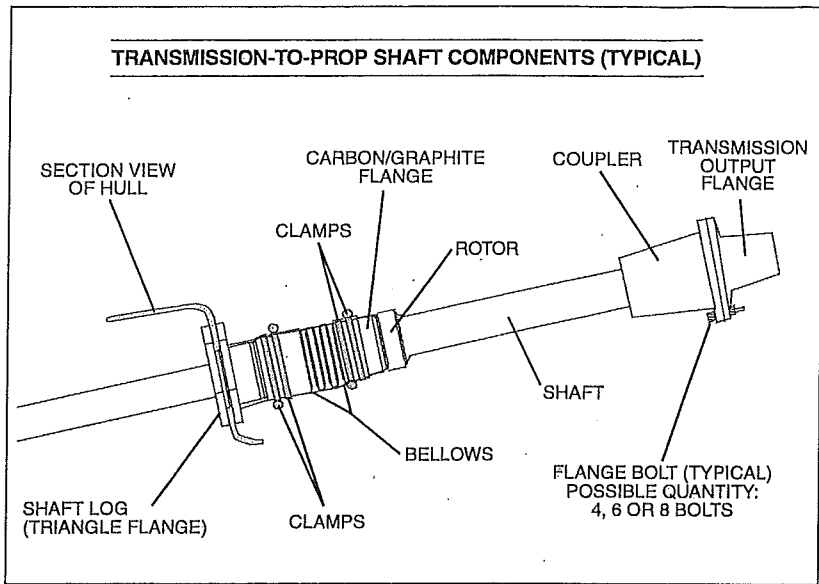

**! CAUTION!**

**SYSTEM DAMAGE HAZARD!** If you suspect a shaft-transmission misalignment, have a qualified mechanic perform an alignment as soon as possible. Continued use may lead to premature engine, transmission, shaft, shaft seal and/or hull damage.

**Shaft Log Packless Sealing System**

The shaft log packless sealing system's shaft seal is a maintenance-free, watertight seal that doesn't require packing or adjustments.

**Oil Change System (Option)**

Your yacht may be equipped with an optional oil change system.

This system allows you to easily change the oil in your yacht's engines and generator without the use of tools.

- The oil change system lets you to pump out (some or all) old oil, or pump in fresh oil to the engines or generator.
- Before using this system, we suggest that you read the manufacturer's operating instruction manual supplied in your yacht's owner's packet.

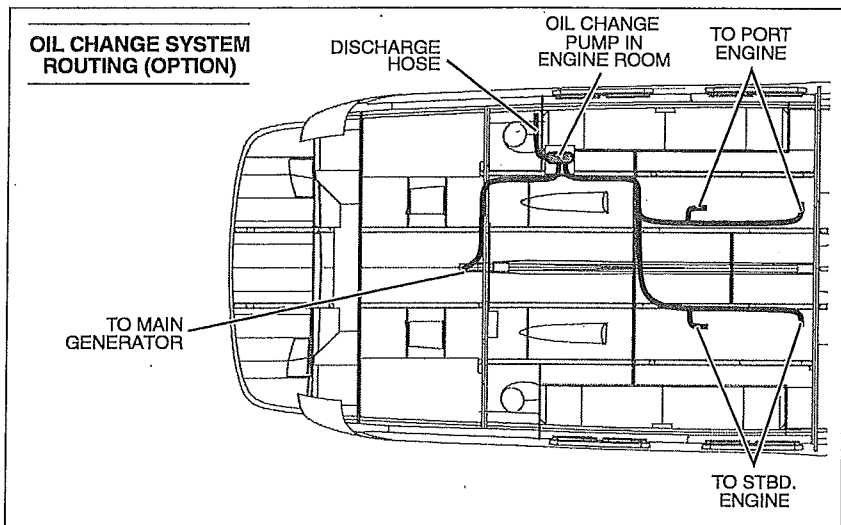

## Fire Extinguishing System (Option)

Your yacht may feature an **optional** fire extinguishing system. This system is designed to automatically activate whenever direct heat from a fire is detected in the engine room or generator compartment.

We *strongly* recommend that you read and understand the fire extinguisher system's instruction and maintenance manual *before* using your yacht for the first time and observe the following:

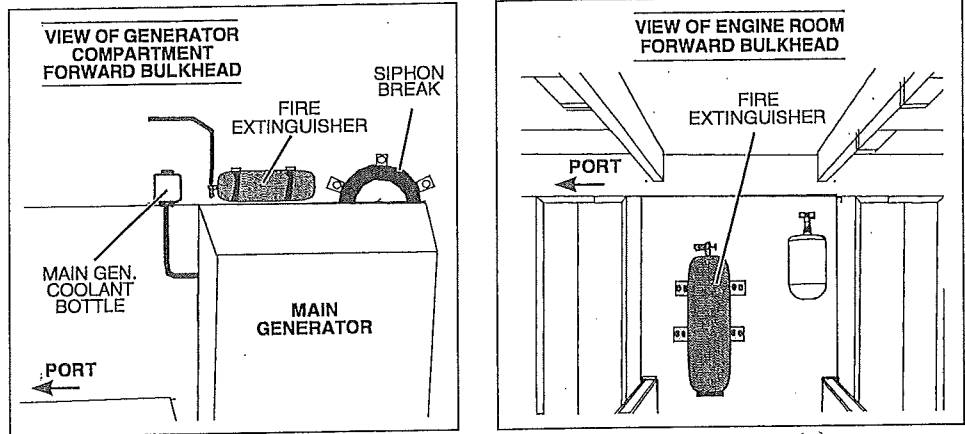

- When the fire extinguishing system is activated, both engines will automatically shut down.
- Since the extinguishing agent is completely non-residual, it is often possible to restart the engines after an extinguisher has discharged in the engine room. Before attempting to restart the engines, however, you must activate the fire extinguisher system's override switch, located at each helm station.
- Extinguishers should be removed semiannually and inspected according to the manufacturer's manual.

## Controls

### Steering & Shift/Throttle System

Your yacht is equipped with a manual hydraulic steering system, therefore the system will not operate as easily as a car's power steering.

- A rhythmic pulsing when turning the wheel is a characteristic of the pump and is *not* a malfunction. Also, when coming off a hard-over position, resistances may be felt, followed by a distinct sound. This is a normal situation resulting from the release of the check valve.
- The fluid reservoir for the hydraulic steering system is located behind the command bridge helm. The shifter/throttle fluid reservoir is located on the forward engine room bulkhead. Follow the instructions and maintenance suggestions in the steering manual and on the reservoir. Check the fluid level and pressure regularly.

### Steering & Shift/Throttle Routing

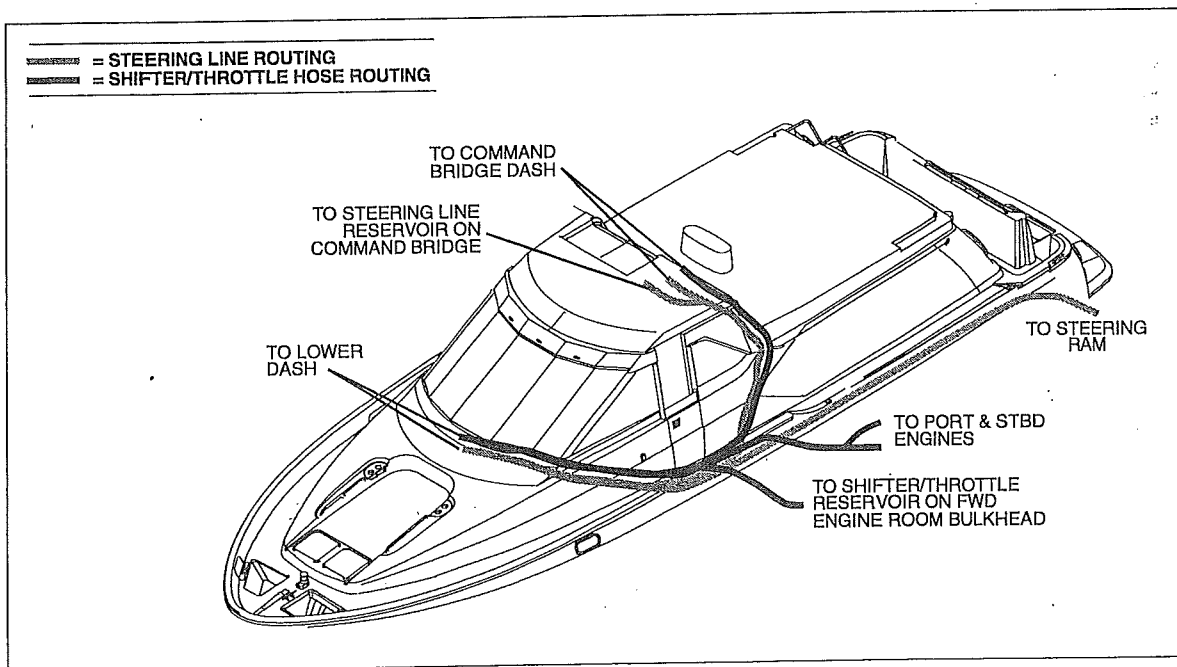

## Shifter/Throttle Reservoir Routing

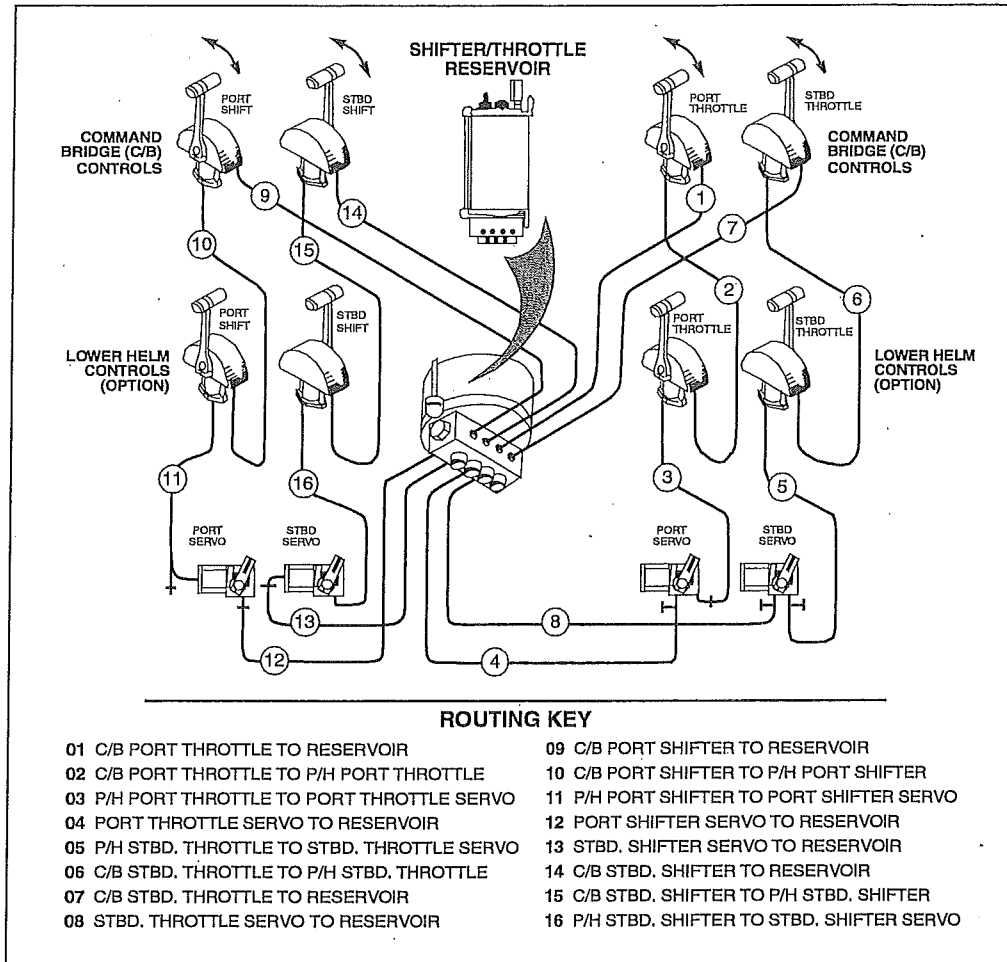

### Trim Tabs

Trim tabs control the longitudinal and lateral trim of your boat at cruising speeds and are controlled by two rocker switches. Rocker switches that control trim tab operation are located at each helm station.

Before using the trim tab rocker switches, we strongly urge you to read and understand the trim tab operation manual included in your yacht's owner's packet. Always observe the following:

- Once the best bow cruising trim is reached, use the port or starboard trim switches (one at a time) to correct unequal lateral loading. *Do not* use trim tabs to compensate for excessive unequal weight distribution.
- Trim tab adjustment should be performed by several short touches to the switch rather than one long one. After each short touch allow about five seconds for the hull to react.
- The trim tab hydraulic fluid reservoir is located in the aft cockpit compartment. The fluid level should be checked periodically (at least once a year) and refilled as necessary.

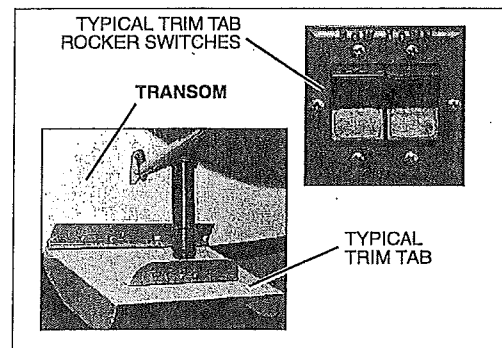

## ⚠ WARNING!

**Improper use of trim tabs may cause loss of control:**

- *Do not* use trim tabs in a following sea as they may cause broaching or other unsafe handling characteristics.
- *Do not* allow anyone unfamiliar with trim tabs to operate them.

**Bow Thruster**

Your yacht may feature an **optional** bow thruster which can be controlled from either helm. The bow thruster allows you to maneuver the yacht into close quarters when docking. Access to the bow thruster motor is through the carpeted cutout in the forward stateroom floor.

Please refer to the bow thruster's operation manual included in the yacht's owner's packet before operating the bow thruster for the first time.

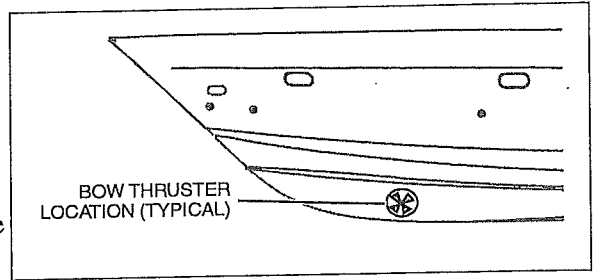

**Rudder Stuffing Gland**

The rudder stuffing gland is part of the assembly where the rudders emerge from the bottom of the boat. The shaft stuffing gland should *not* leak any water.

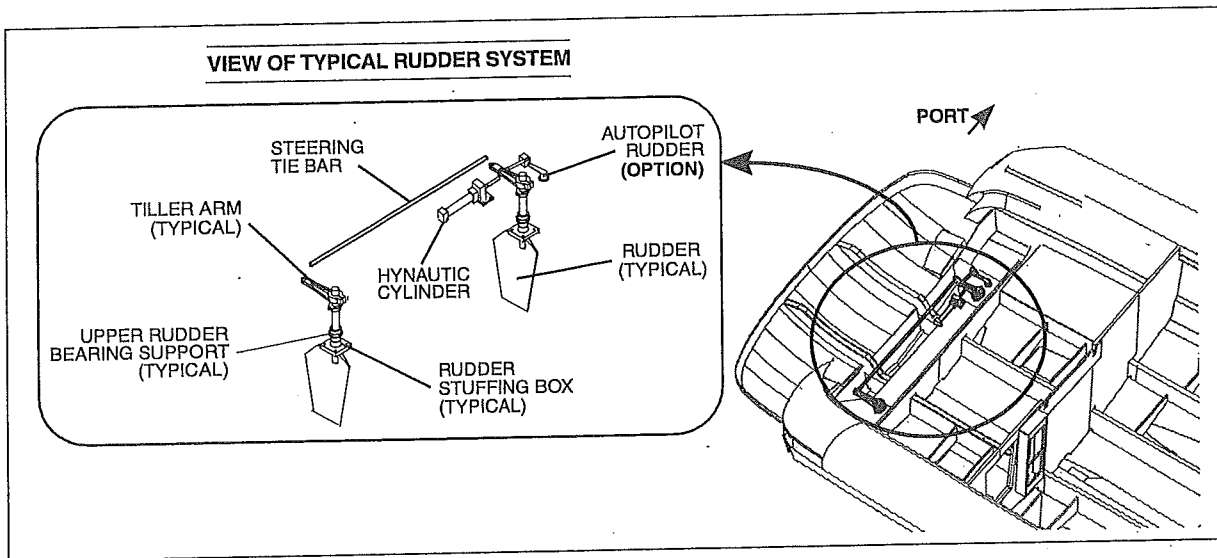

**Bilge**

**Bilge Pumps**

Your yacht is equipped with four impeller-type bilge pumps, which are used to pump out water in the bilge. Bilge pumps are controlled by automatic bilge pump float switches (autofloat switches) and/or switches on the dash panel.

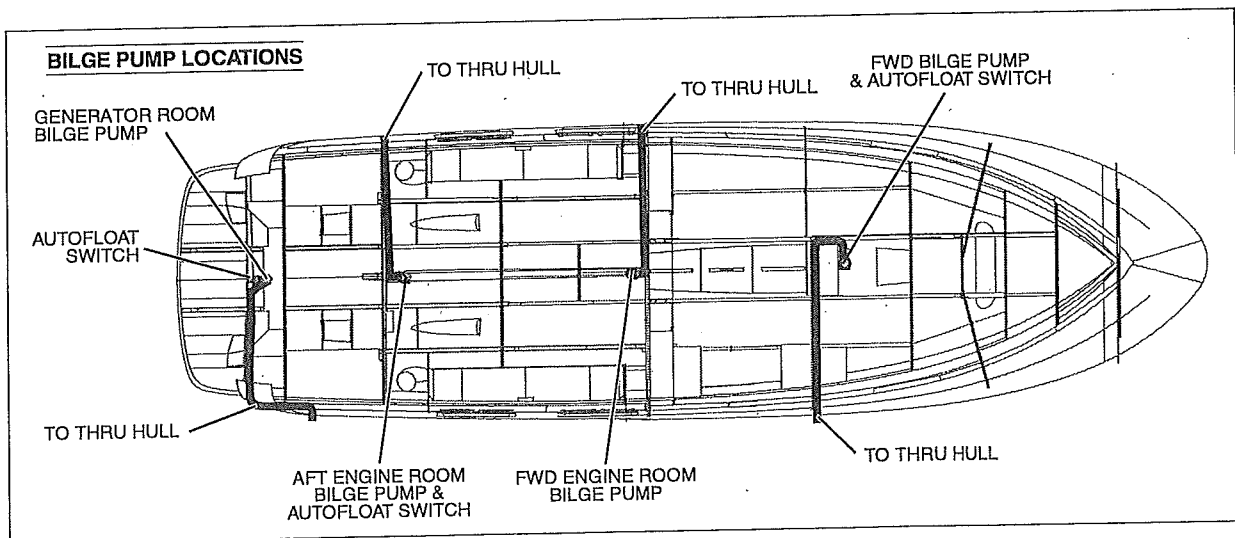

There are two types of bilge pumps (type A and B) installed on your yacht. These pumps should be tested often to verify they are working properly. To test a bilge pump, activate the dash-mounted switch and verify that water in the bilge is being pumped overboard. If bilge water is present and the pump motor is running but *not* pumping, inspect the discharge hose for a kink or collapsed area. If no problems are found, check the bilge pump housing for clogging debris as follows:

**To check for clogging debris in type "A" pumps:**

1. Remove the power cartridge:
  - a. Lift the tab while rotating the fins counterclockwise.
  - b. Lift out the power cartridge.
  - c. Clear the outer housing of debris.
2. Reinstall the power cartridge:
  - a. Make sure the "O" ring is properly seated.
  - b. Coat the "O" ring with a light film of vegetable or mineral oil.
  - c. Align the two cams on either side of the power cartridge with the two slots on the outer housing and press the power cartridge into the housing while twisting clockwise.
  - d. To ensure proper reinstallation, attempt to twist the fins counterclockwise without lifting the tab: The cartridge should stay in place.

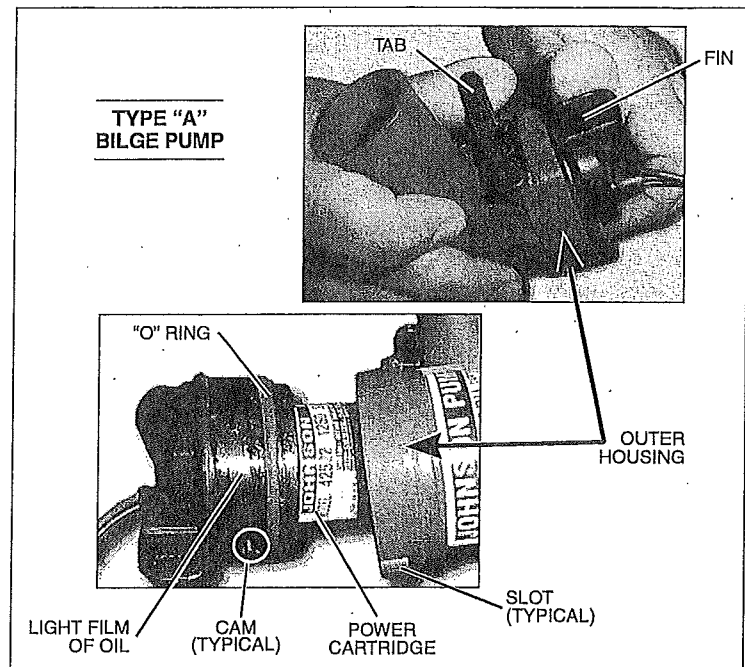

**To check for clogging debris in type "B" pumps:**

1. Locate the two black tabs on opposite sides of the bilge pump. Push the tabs in simultaneously and pull the pump away from the base.
2. Clean debris from the base and the bottom opening of the pump.
3. Reattach the pump to the base by aligning the tabs on the base to the tab holes on the bottom of the pump. Once aligned, push the pump down onto the base until secured.

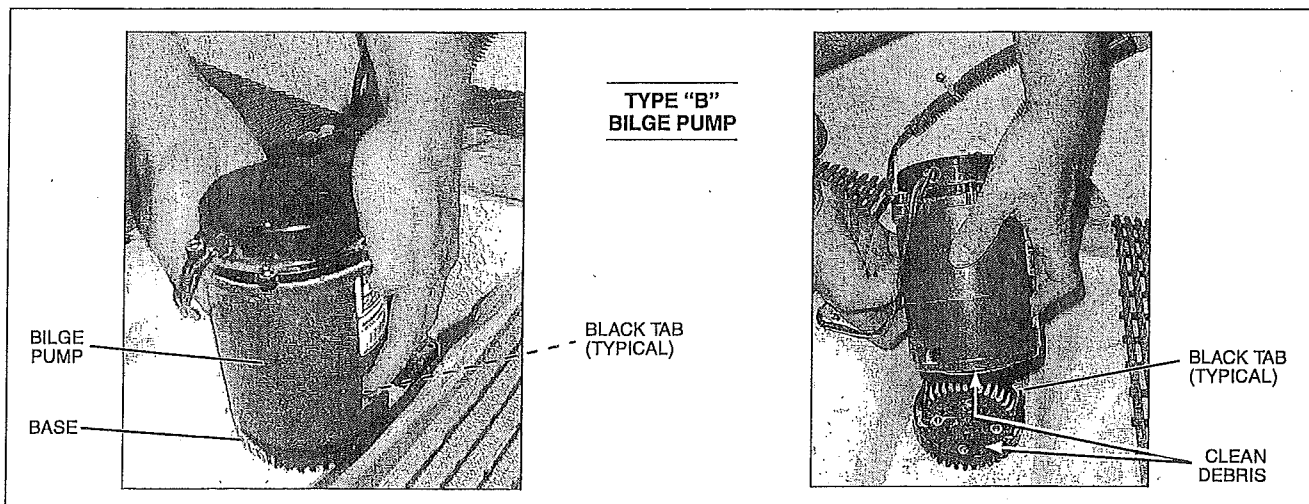

## NOTICE

Discharge of oil, oil waste or fuel into navigable waters is prohibited by law. Violators are subject to legal action by the local authorities.

**Autofloat Switches**

Automatic bilge pumps use an electromagnetic float (autofloat) switch to automatically activate the pump whenever water accumulates above a preset level in the bilge. Autofloat switches are mounted next to the bilge pump it activates, and are wired directly to the battery so they will normally function even when the yacht is completely shut down and left unattended.

Autofloat switches should be tested often for proper operation:

To test a *type "A"* float switch:

1. Lift the float *up* by turning the plastic float switch insert (where the wires enter the housing) 1/4 turn counterclockwise. As the float is lifted, the bilge pump should turn on.  
If lifting the float does not turn the pump on, check the inline fuse. If the fuse is good but the switch does not work, it may indicate a bad switch or possibly a low battery.
2. Release the plastic insert to automatically lower the float and return the float switch to auto mode.

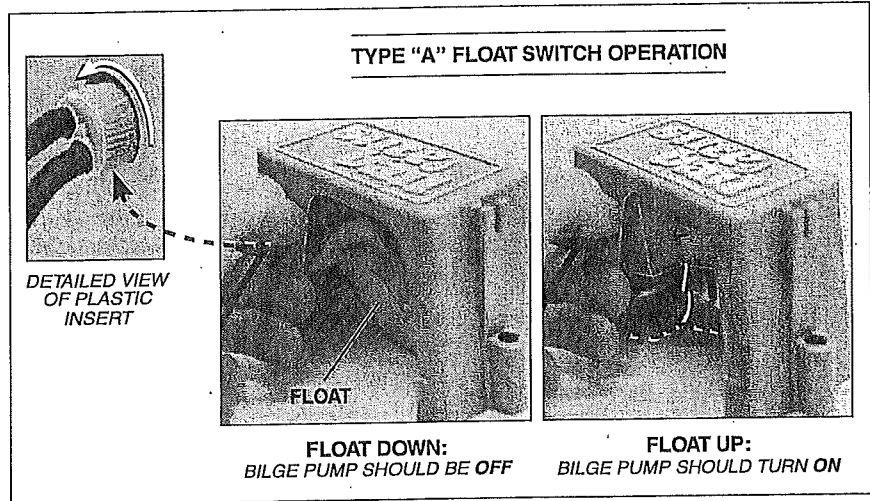

To test a *type "B"* float switch:

1. Push the float switch test button *up* to activate the bilge pump.  
If the pump does not turn on, check the inline fuse. If the fuse is good but the switch doesn't work, it may indicate a bad switch or possibly a low battery.
2. Push the test button all the way *down* to return the float switch back into the auto mode.

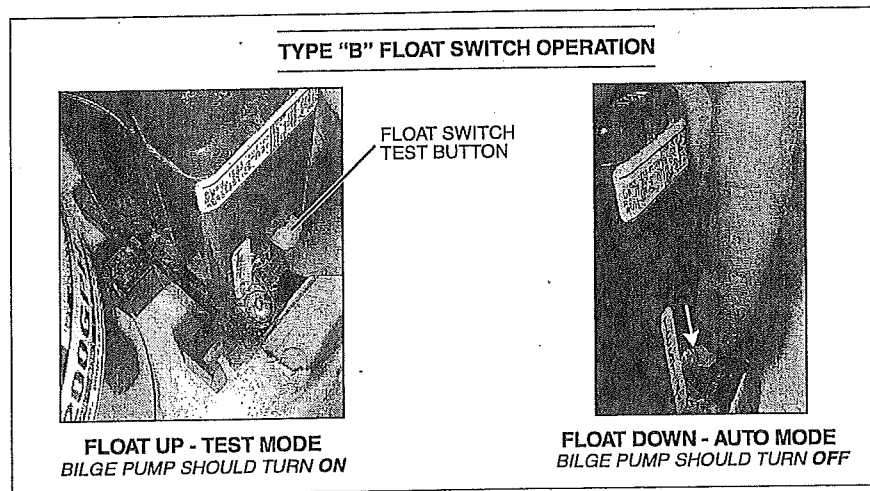

**CAUTION!**

When test is completed on a type "B" float switch, you **MUST** push the test button *all the way down* to the auto position to turn the switch back into auto mode!

**Fuel System**

Carefully read the fuel section of the Owner's Manual and the engine operation manual, paying special attention to the subject of *fuel recommendations*. These manuals can be found in your yacht's owner's packet.

**Fuel Fills & Vents**

- Fuel fills are located on the port and starboard side decks, just aft of the bow rail. Fuel receptacle caps are marked "Diesel". If you experience difficulty filling a fuel tank, check to see that the fuel fill and vent lines are free of obstructions and kinks.
- Fuel vents are located in the hull below the same general area as the fill.

## ⚠ WARNING!



### **FIRE & EXPLOSION HAZARD!**

- It is very important that the fuel system be inspected thoroughly the first time it is filled and at each subsequent filling.
- The fueling instructions in the Owner's Manual and the fuel recommendations in the engine operation manual *must* be followed.

## ⚠ CAUTION!

- Air in the diesel supply system can stop an engine or severely restrict performance. If you suspect air in the fuel lines, refer to your engine operation manual for detailed instructions on how to *bleed* the system.
- Avoid the storage or handling of gear near the fuel lines, fittings and tank.

### Fuel Tank Routing

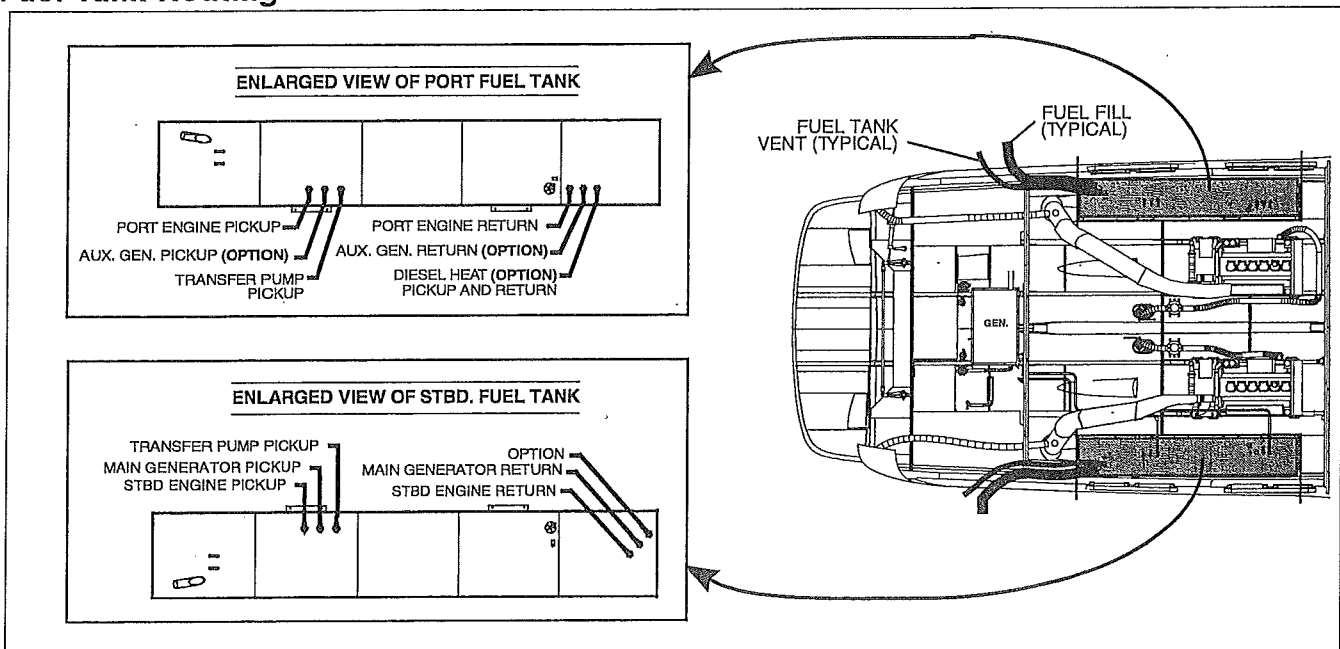

### Fuel Quality

- Make sure your diesel fuel suppliers are reputable and can be relied upon to furnish clean, high quality fuel. Once you have found such suppliers, keep your tank as full as possible with their fuel, allowing for expansion due to temperature variations. Then, if you are forced to add to the tank with a potentially poor quality supply, the portion of poor quality fuel will be minimized.
- Ask your dealer or local marina about fuel additives that help prevent fungus growth or buildup in your tanks.

### Fuel Transfer Pump

Fuel transfer pumps are used to draw fuel from a full tank to a nearly empty tank. The transfer pump is activated by the fuel transfer switch, located at the pilothouse helm station.

## ⚠ CAUTION

**ENVIRONMENTAL HAZARD!** NEVER transfer fuel into a full (or nearly full) fuel tank. Fuel transferred into a full tank may spill overboard through the tank venting system.

**Fuel System Routing**

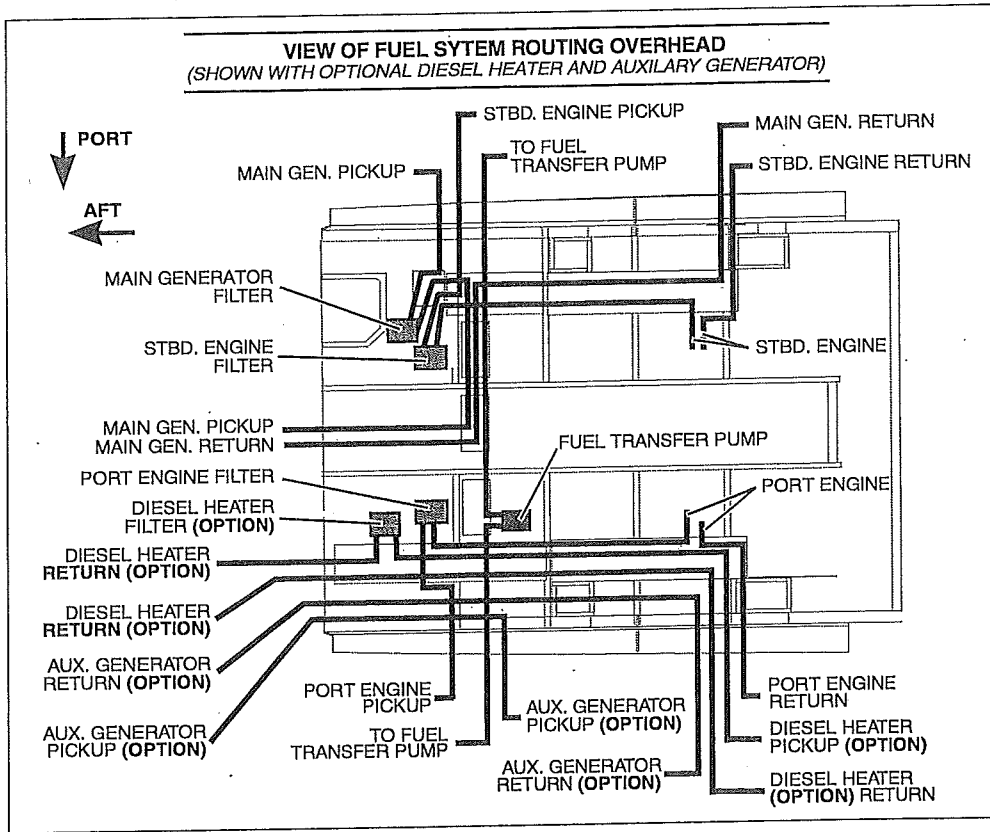

**Fuel Filters & Separators**

Fuel filters and separators should be inspected periodically for debris and replaced as needed (according to the instructions detailed in your engine manual, generator manual and in the filter literature).

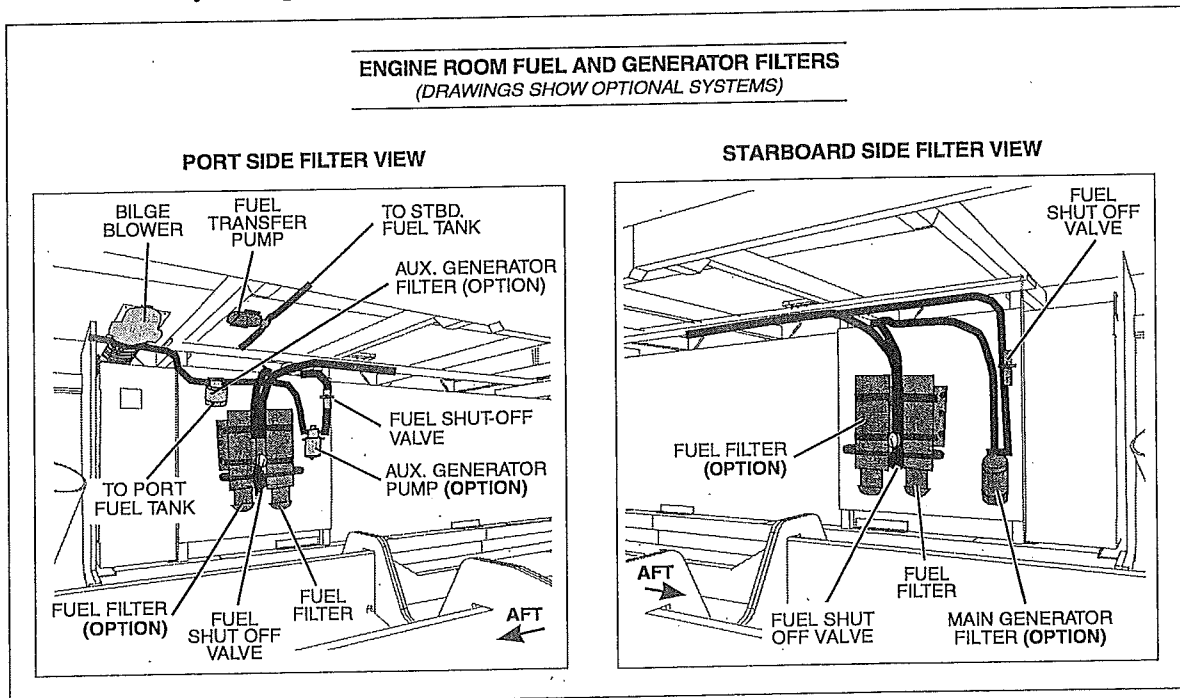



## Freshwater System

- The water tank fill fittings are located on the port and starboard side decks. The city water inlet is located on the port side of the aft cockpit.
- A pressure accumulator tank is installed in the freshwater system. The pressure accumulator tank assists the pressure pump by reducing on/off cycling and distributing an even flow of water.
- The *water pressure breaker* (on the DC panel) controls the water pump and should be turned **off** when any of the following occurs:
  - a. When the boat is not in use.
  - b. Before pumping one or both water tanks dry.
  - c. When one of both water tanks are empty.
  - d. When connected to a dockside water supply (the switch can be activated when *not* connected to a dockside water supply).
- When your boat is to be left unattended for long periods of time, pump the water tanks dry to prevent stored water from becoming stagnant and distasteful. Should it become necessary to disinfect the freshwater system, ask your dealer about treatments available for your yacht's system.
- The water filter, located in the engine room near the water pump, should be inspected and cleaned often.
- The water level monitor, located on the DC panel, displays the amount of water in both of the water tanks simultaneously. To check water level, on the DC panel: Make sure the *water tank monitor breaker* is activated then press the *water tank momentary switch*.

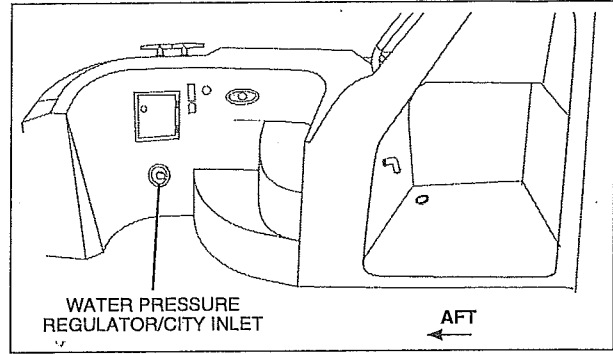

## NOTICE

The water level monitor may not be 100% accurate, so you should fill the water tanks at every opportunity to avoid running short of freshwater.

## Water Heater

Your yacht is equipped with a water heater, which can be accessed through the master stateroom's forward bulk-head wall cutout.

Since the water heater is connected to the AC power system, you must verify that the water heater breaker on the AC panel is turned *on* before the water will be heated.

Please read the manufacturer's instruction manual supplied in your yacht's owner's packet and observe the following warnings:

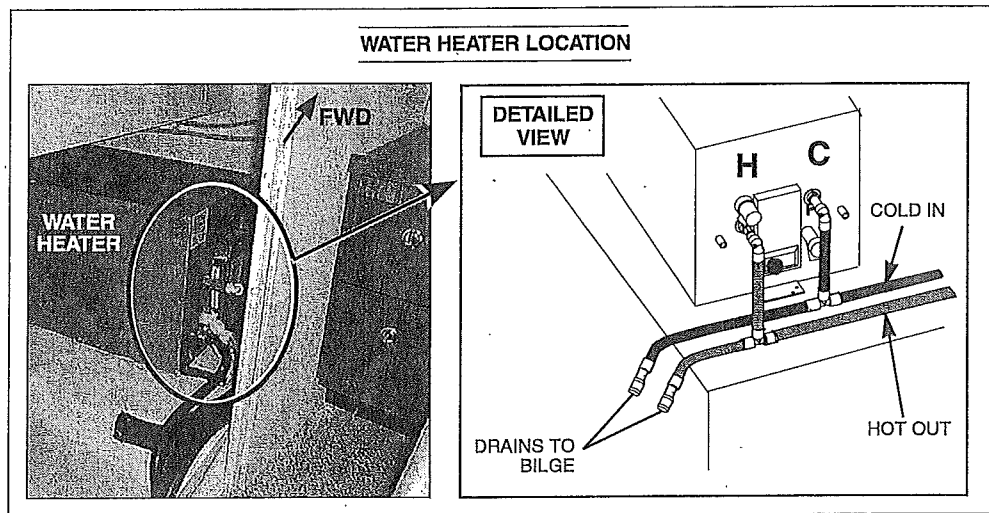

## ⚠ WARNING!

**SCALDING HAZARD!** Water heated by the water heater can reach temperatures high enough to scald the skin.

## ⚠ CAUTION!

**COMPONENT DAMAGE HAZARD!** Water heaters must be kept full of water to avoid damage to the 120v heating elements. They should also be drained (power turned *off*) when the possibility of freezing exists.

**Shower Sump Pump**

- Sinks above the waterline are gravity drained overboard (gray water), while heads, sinks and showers below the waterline are pump-drained into a holding tank using a shower sump pump.
- The shower sump pump can be accessed through the cutout in the hallway at the bottom of the stairs leading to the stateroom.

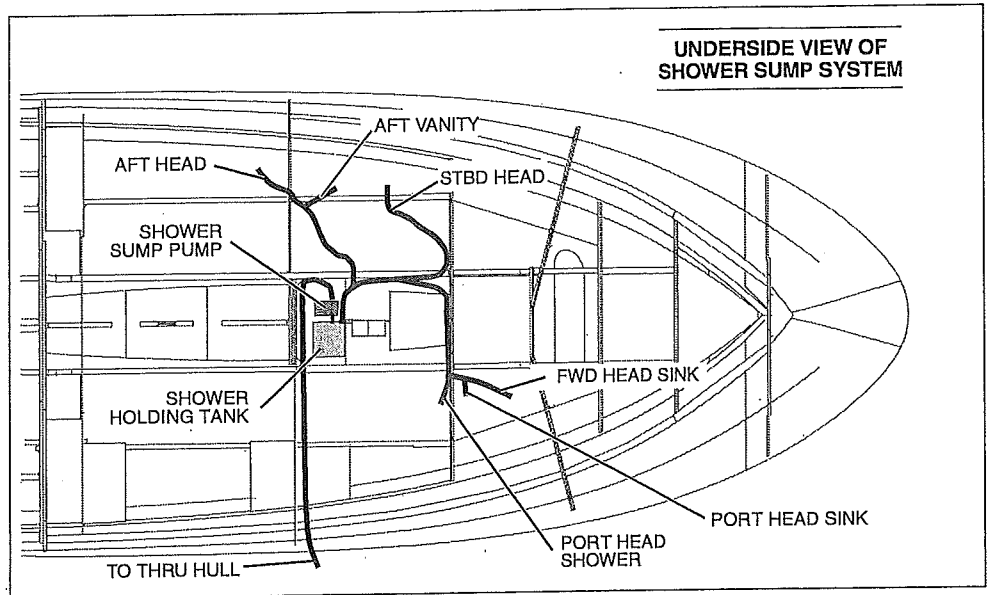

**Hot & Cold Water Routing**

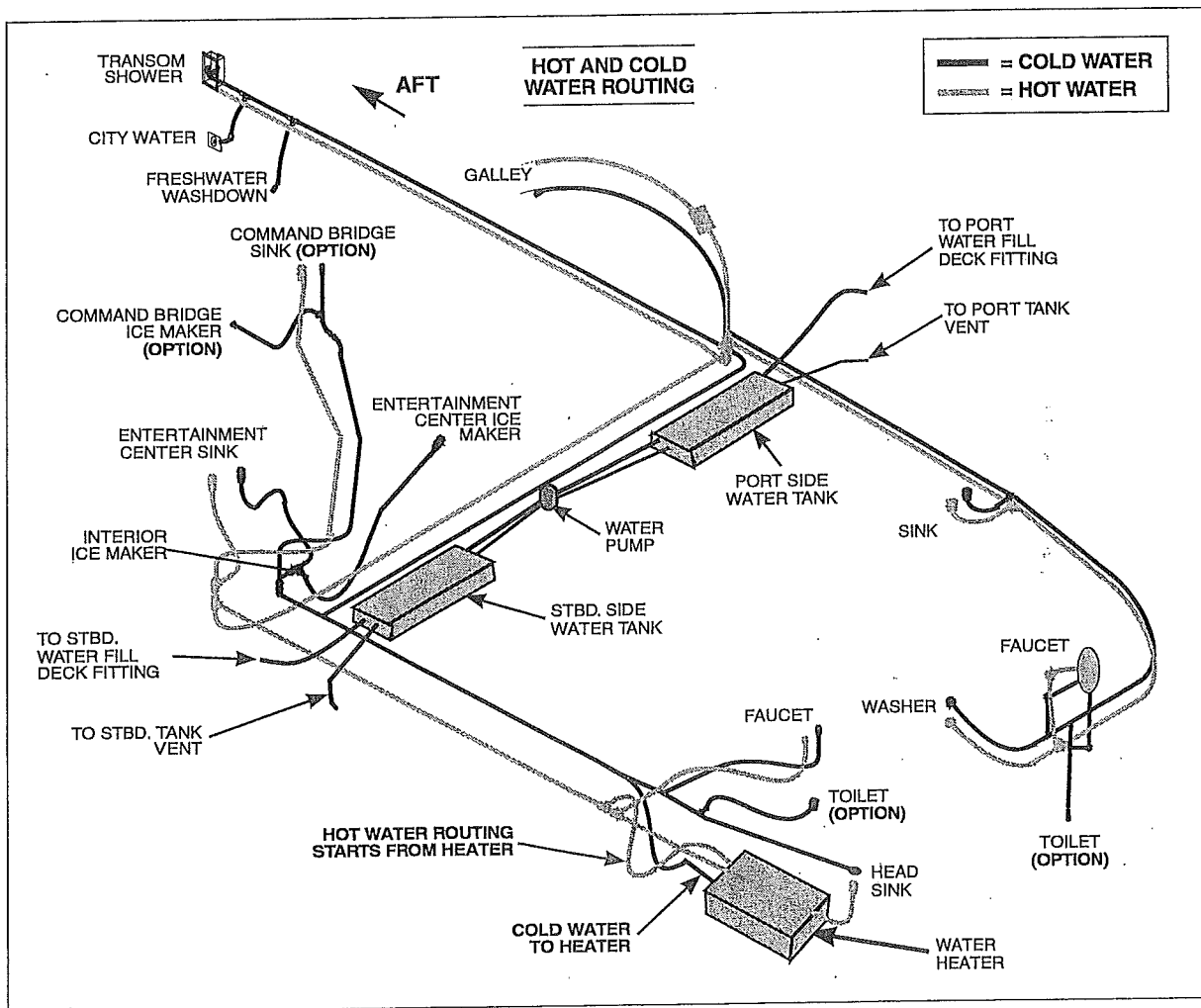

### Freshwater Washdown

The outlet for the freshwater washdown system is located on the port side of the cockpit.

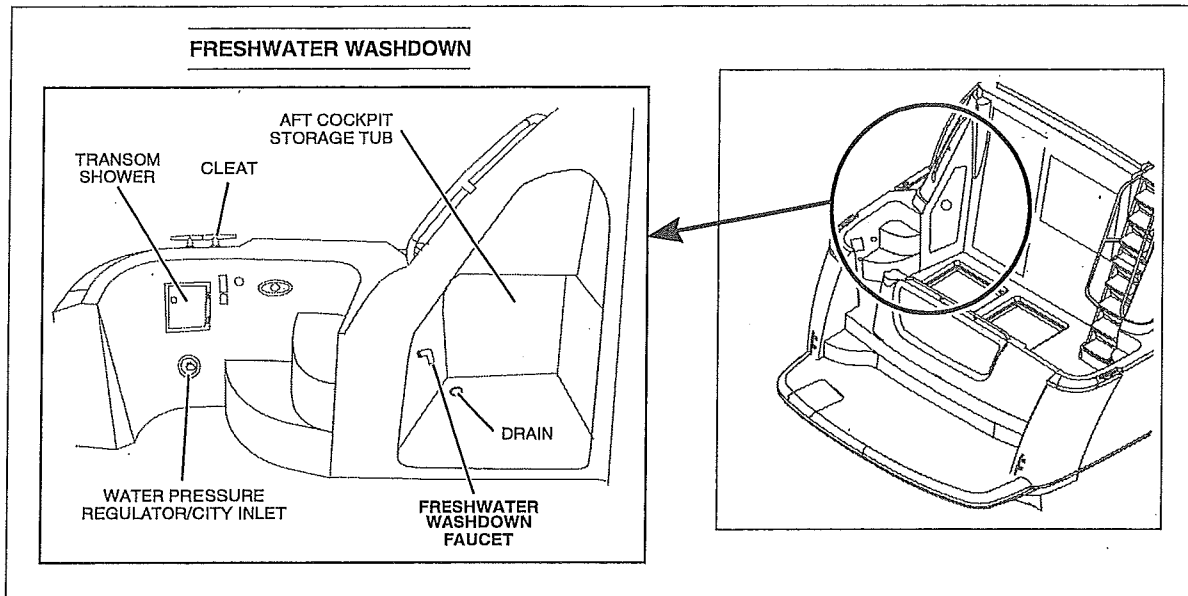

## Seawater System

### Seawater Strainers

Seawater strainers are used in water pickup systems to filter incoming seawater. The seawater strainers, located in the engine room and generator compartment, should be checked regularly for leaks and/or debris. The typical layout is one strainer for each of the following: Engine, raw water washdown, generator, **optional** water maker and **optional** air conditioning/heating systems.

#### Cleaning a seawater strainer:

1. Make sure the component/system (engine, generator, etc.) that the strainer is connected to is turned *off*
2. *Close* the seacock that sends water to the strainer you are about to clean. The seacock *must* remain closed until the strainer is completely reassembled.
3. Take apart the seawater strainer and remove debris
4. Reassemble the seawater strainer
5. Open the seacock *before* turning on the component/system.

#### ⚠ CAUTION!

The seacock that sends water to the seawater strainer must be *closed* before disassembling the seawater strainer to prevent the yacht from taking on water through the seawater strainer assembly. Keep the seacock *closed* until the seawater strainer is completely reassembled.

#### ⚠ CAUTION!

**SYSTEM DAMAGE HAZARD!** After reassembling the seawater strainer, verify that the seacock valve is *open* before/during component/system operation.

**Water Maker (Option)**

Your yacht may feature an **optional** water maker (reverse osmosis desalinator), which converts sea-water to freshwater.

- The watermaker is located in the starboard aft corner of the engine room, next to the engine room entry.
- Make sure the seacock is open before using the watermaker. The seacock must remain open anytime the water maker is in use.
- Be sure to read the water maker's operation manual, included in your yacht's owner's packet, to learn more about this system.

*The water maker is used to convert seawater to freshwater.*

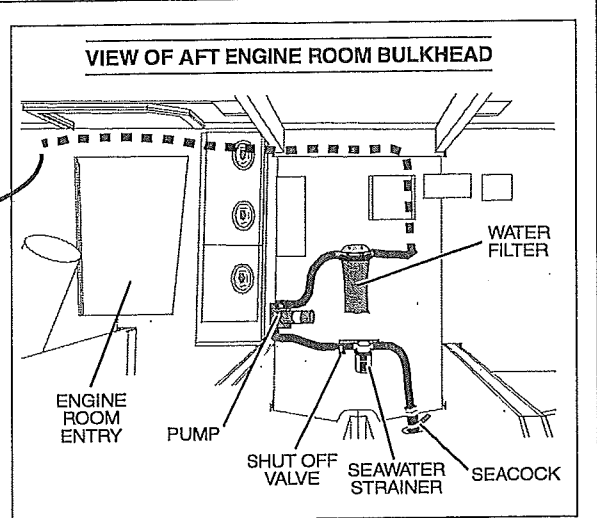
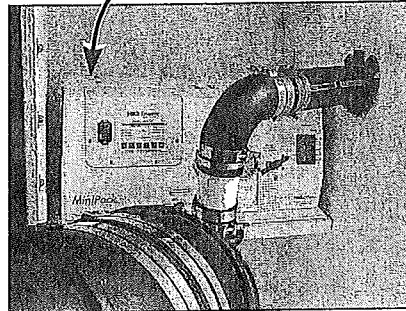

**Raw Water Washdown**

The outlet for the raw water (seawater) washdown system is located on starboard side of the forward deck. Make sure the seacock is open before turning the raw water washdown system on.

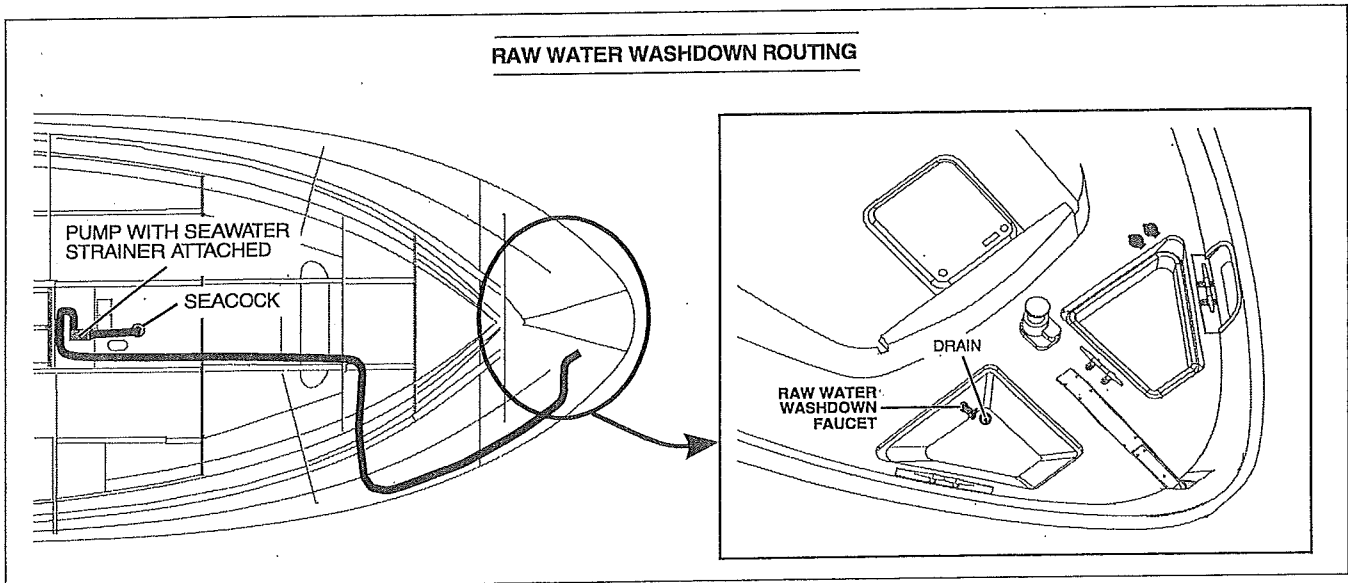

**Air Conditioner & Heater (Option)**

Your yacht may be equipped with an **optional** air conditioning (A/C) and heating system.

- Both heating and cooling are controlled from the same panel.
- Before operating the air conditioning and heating unit, make sure the breakers on the AC panel are activated
- Make sure the seacock is open before using the air conditioning/heating system. The seacock must remain open anytime the air conditioner/heater is in use.
- For further operating instructions, please read the a/c and heating manual included in your yacht's owner's packet.

**Air Conditioning Routing**

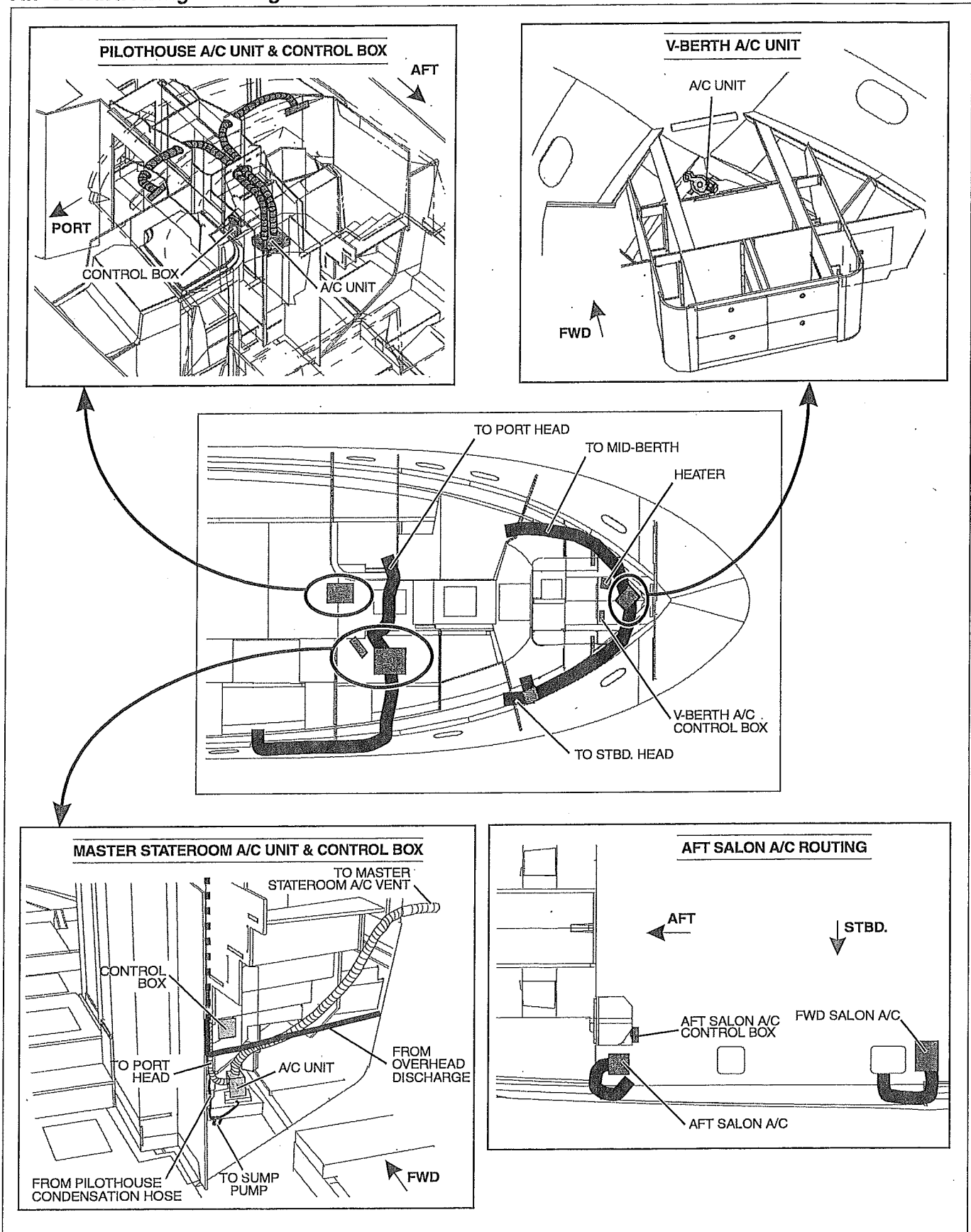

### Diesel Heater & Defroster (Option)

Your yacht may be equipped with an **optional** diesel heater and defrosting system. Operating instructions for this system can be found in the manufacturer's instruction manual included in your yacht's owner's packet.

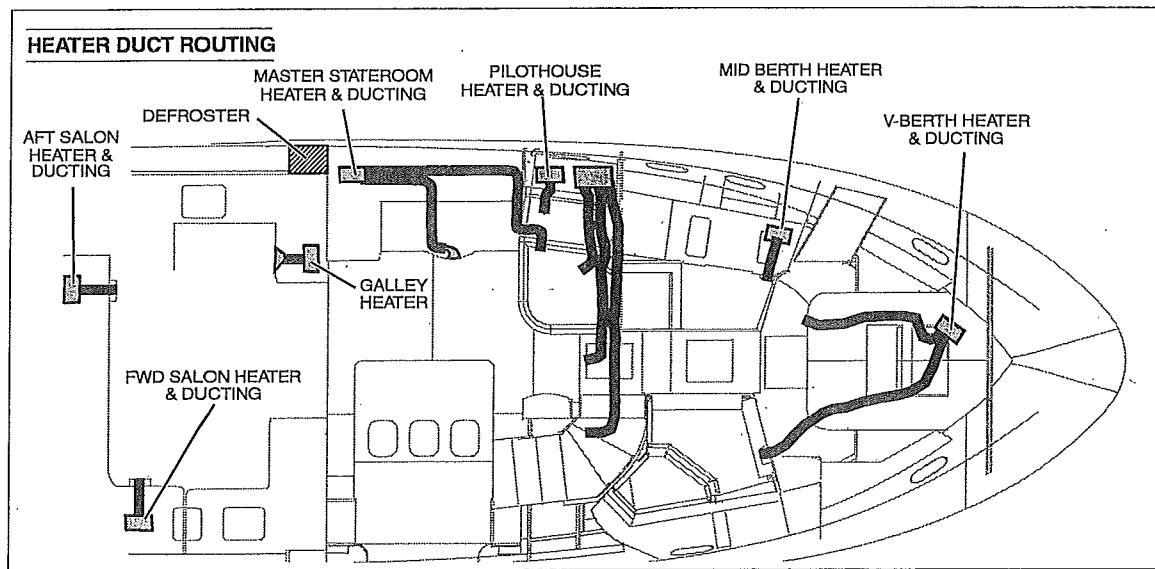
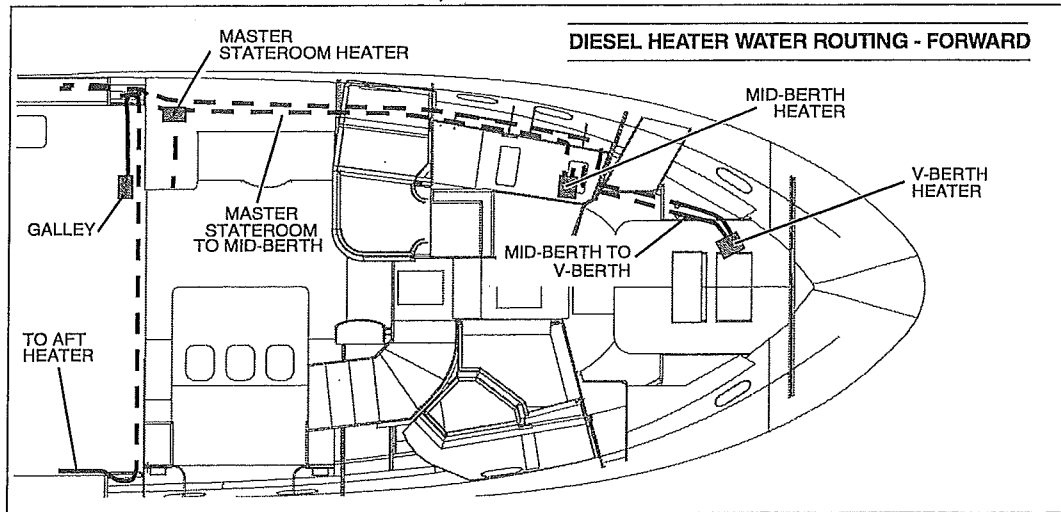
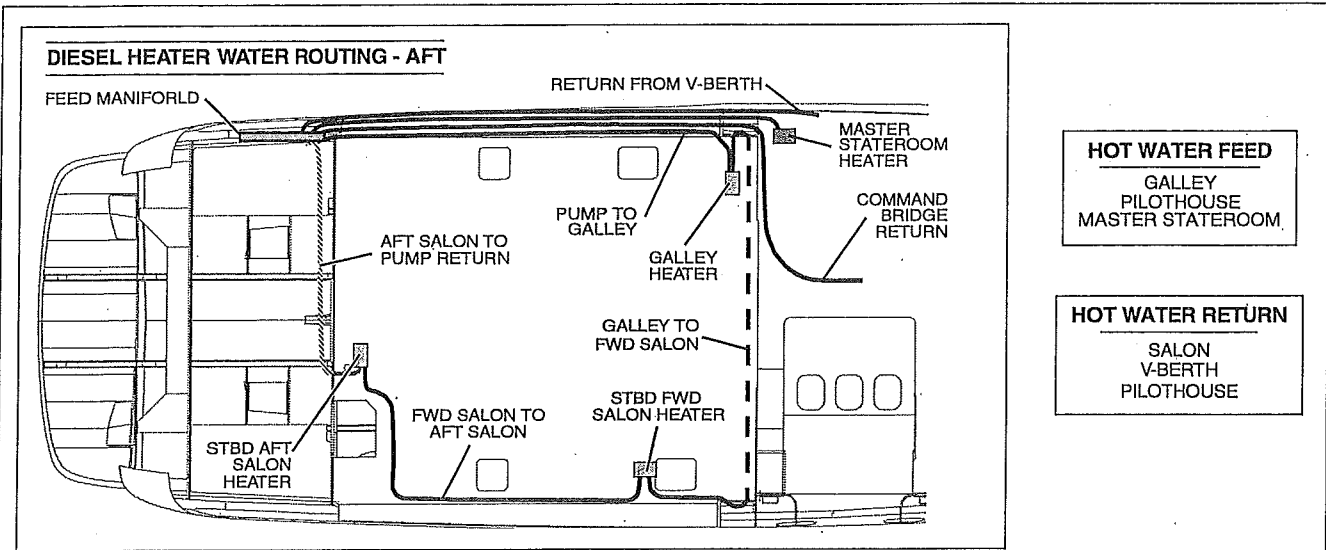

## Marine Head System with Holding Tank

Each head (toilet) comes with its own instruction manual. Please refer to this manual for detailed information and winterizing recommendations regarding your yacht's head system.

- The marine head system installed on your yacht is designed so that waste from each head may be flushed into the holding tank or pumped overboard (where regulations permit). Routing is decided by the setting of the head's Y-valve. Access to the head Y-valves is through the hallway floor cutout, at the bottom of the forward stairs.
- The holding tank can be emptied by dockside pump-out or, where permitted, by actuating the macerator pump from the pilothouse DC panel. The holding tank is located under the master stateroom and can be accessed through the cutouts in the closet floor.
- The holding tank features a level indicator, located on the DC panel. We recommend emptying the tank at every opportunity to reduce the possibility of problems caused by an indicator error.
- Make sure the seacock is open before using the head.
- Check the local regulations regarding the legal use of marine head systems in your area.
- Your yacht may feature an **optional** Vacuum head system which includes two vacuum generators and an additional tank vent (see drawing below).
- *Check the local regulations regarding the legal use of marine head systems in your area.*

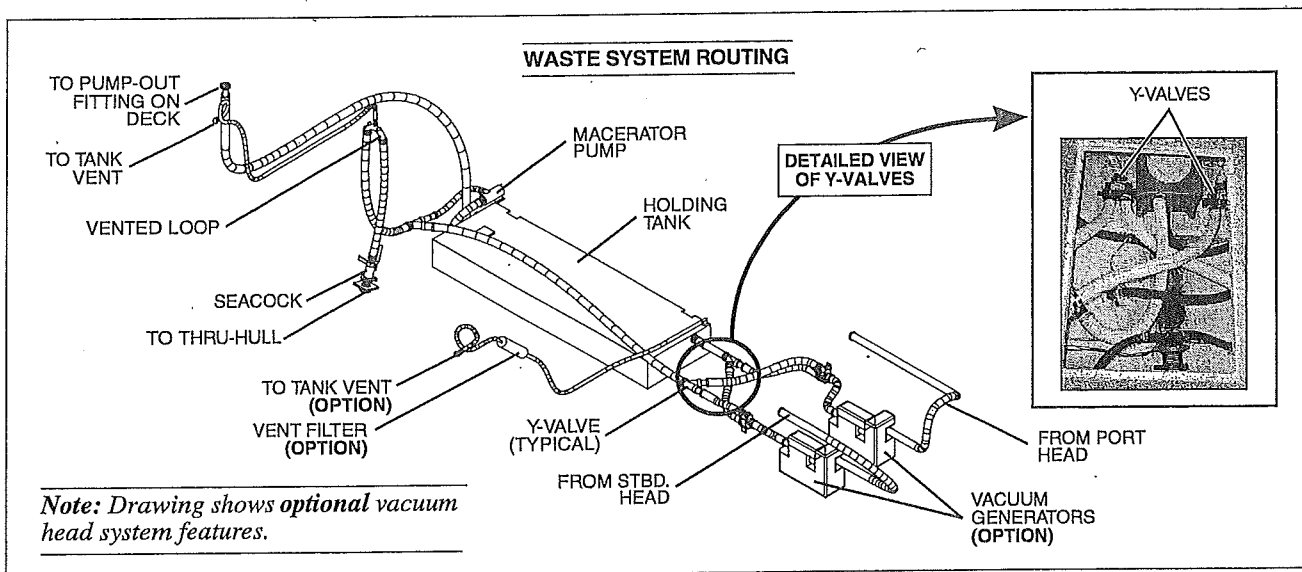

## Vacuum System

Your yacht features a built-in vacuum system. The vacuum hose receptacles are conveniently located inside the aft galley port salon cabinet and in the master stateroom's port side TV cabinet. Before attempting to operate the vacuum, make sure the breaker switch on the AC master panel is turned *on*. Refer to the vacuum operation manual included in your yacht's owner's packet for further instructions.

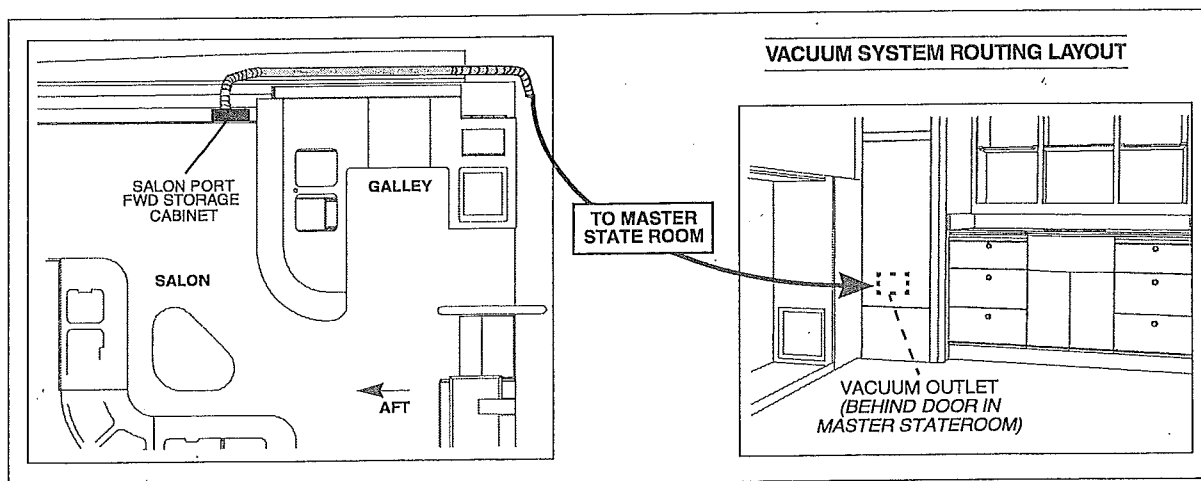

## Electrical System

We strongly recommend you read and understand this chapter and the electrical section of the *Owner's Manual*.

**⚠ DANGER!**

 **EXTREME FIRE & EXPLOSION HAZARD!**

- To minimize the risks of fire and explosion, *never* install knife switches or other arcing devices in the fuel compartments.
- *Never* substitute automotive parts for marine parts. Electrical, ignition and fuel system parts were designed and manufactured to comply with rules and regulations that minimize risks of fire and explosion.
- *Do not* modify the electrical systems or relevant drawings.
- Only qualified personnel should install batteries and/or perform electrical system maintenance.
- Insure that all battery switches are in the *off* position before performing any work in the engine spaces.

**⚠ WARNING!**

 **FIRE & EXPLOSION HAZARD!**

- Fuel fumes are heavier than air and will collect in the bilge areas where they can be accidentally ignited. Visually and by smell (sniff test), check the engine and fuel compartments for fumes or accumulation of fuel. Always operate the bilge blowers for at least four minutes prior to engine starting, electrical system maintenance or activation of electrical devices.
- Minimize the danger of fire and explosion by not exposing batteries to open flame or sparks. It is also important that no one smoke anywhere near the batteries.

**⚠ CAUTION!**

 **SHOCK & ELECTRICAL SYSTEM DAMAGE HAZARD!**

*Never* disconnect the battery cables while the engine is running since it can cause damage to your boat's electrical system components.

**NOTICE**

- Electrical connections are prone to corrosion. To reduce corrosion caused electrical problems, keep all electrical connections clean and protect them with a spray-on protectant such as Corrosion Guard®.
- **VOLTAGES** - Boats use either 120v AC/60Hz or 240v AC/60Hz systems and 12v DC or 24v DC. Voltage and frequency of AC and DC are labeled on the electrical distribution panel.



## DC Electrical System

### Circuit Breakers

- Individual component circuit breakers are found on the DC breaker panel, located inside the DC cabinet on the starboard side of the pilothouse. These breakers must be activated to use the component.
- The master circuit breakers for windlass power and davit power are located next to the battery switches on the aft engine room bulkhead.

### Batteries

The batteries installed in your yacht's generator room supply electricity for lights, accessories as well as engine and generator starting. Always observe the following:

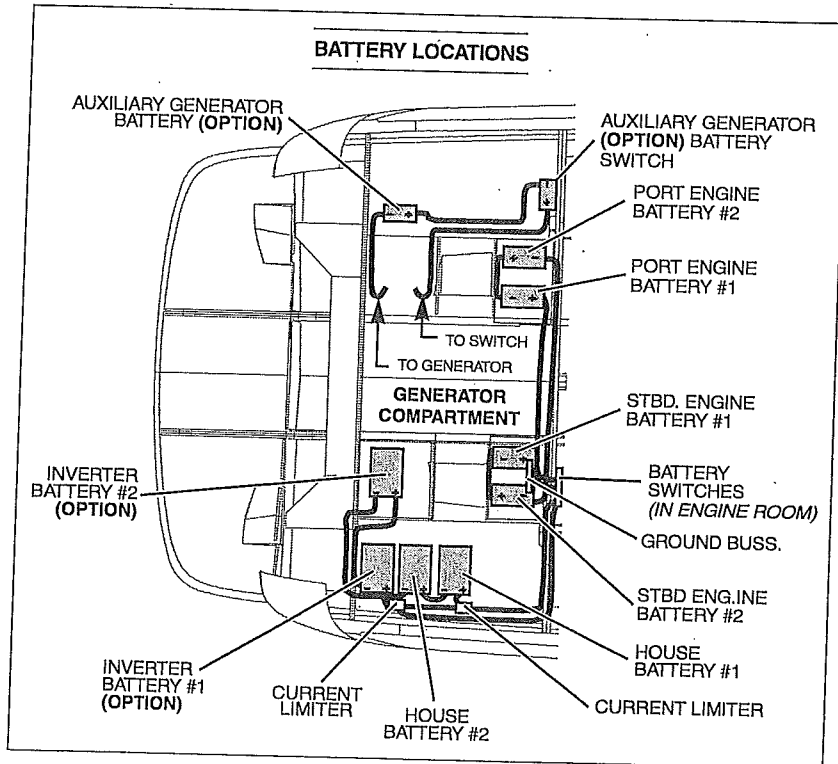
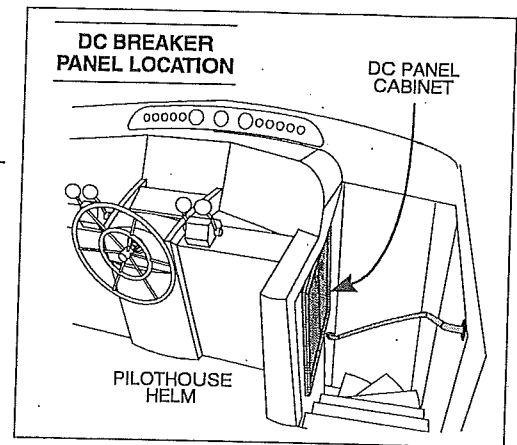

### Battery Maintenance

- Periodically remove the battery caps and check the electrolyte level; if the zinc plates are exposed, add distilled water until they are covered.
- Corroded battery terminals can be cleaned with baking soda and water. After cleaning the terminals, coat them with a light film of battery terminal lubricant and tighten all battery connections.

### Battery Monitor Selector

- The condition of each battery can be checked on the DC panel's battery monitor selector.

### Battery Switches

- Separate rotary battery switches for each battery are located on the aft engine room bulkhead. Generator battery switches are located on the forward port bulkhead in the generator compartment.
- An emergency crossover switch (parallel switch) at the pilothouse helm enables you to start an engine using both engine batteries if the designated engine battery is low.



## CAUTION!

- The crossover switch should be turned on *only* in emergencies.
- *Never* disconnect battery cables or turn off main battery switches while engines are running as this can cause damage to your boat's electrical components.

### Battery Charger

Your yacht is equipped with a battery charger, located on the aft engine room bulkhead. The circuit breaker for the battery charger is located on the AC panel and must be turned *on* for charging to occur.

We recommend that you thoroughly read and understand the battery charger manual provided in your yacht's owner's packet before using the charger.

### Engine Alternators

The engine alternators maintain proper charge levels in the engine and accessory batteries.

**! CAUTION!**

The battery charging systems (alternator and battery charger) installed on your yacht are designed to charge conventional lead-acid batteries. Before installing gel-cell or other new technology batteries, consult with the battery manufacturer about charging systems requirements.

### AC Electrical System

- Your yacht uses 120v AC/60Hz and 240v AC/60Hz systems.
- The AC system can be energized by shore power, inverter power (option) or generator power.
- The master circuit breakers, located on the AC panel, provides power source selections to AC powered accessories.
- This system is designed so that ship's power and shore power sources *cannot* power simultaneously.

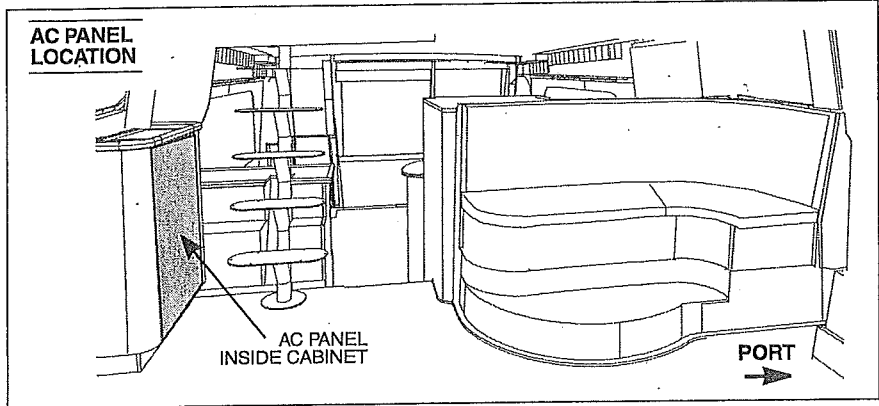

**! CAUTION!**

**WATER HEATER DAMAGE HAZARD!** Do not energize the AC water heater electrical circuit until the heater is *completely* filled with water. Even momentary operation in a dry tank will damage the heating elements. Warranty replacements *will not* be made on elements or tank damaged in this manner.

### Shore Power

The shore power receptacle is located on the aft cockpit transom and is rated 240v/50 amps. Some dockside installations may not be rated for 50 amps, therefore, you may need to purchase lower amp adapters. Whenever a lower amp adapter is used, however, there will be a corresponding drop in supplied power from the dockside system.

- A 50 foot power cord is provided with your yacht
- Before connecting to shore power, ensure all breakers and switches on the AC master panel are in the *off* position and switch off the shore power breaker, located under the shore power receptacle in the generator compartment.

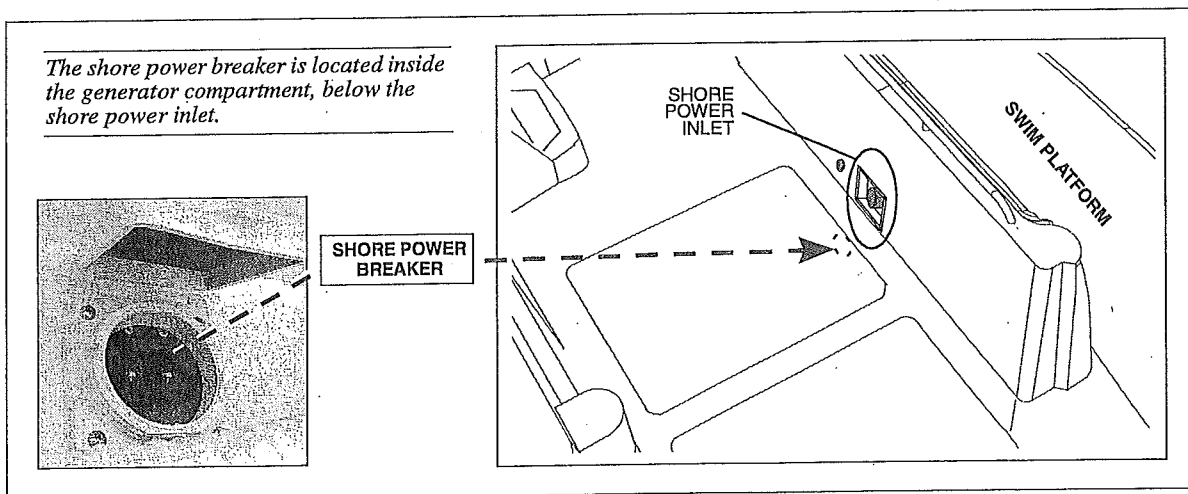

## Connecting to Shore Power

**! DANGER!****FIRE/EXPLOSION & SHOCK HAZARD!**

- To minimize shock and fire hazard, *do not* modify electrical systems or relevant drawings.
- *Do not* alter shore power connectors and use only compatible connectors.
- Only qualified personnel should install batteries and/or perform electrical system maintenance.
- Before connecting to shore power, ensure all breakers and switches on the AC master panel are in the *off* position.
- To prevent shock or injury from an accidental dropping of the “hot” cord into the water, *always* attach the shore power cord to the boat inlet first; then to the dockside connection

**! CAUTION!****SHOCK & ELECTRICAL SYSTEM DAMAGE HAZARD!**

- *Never* connect dockside power to your boat outside North America unless you have purchased the international electrical conversion option, which is rated 220v/50Hz. North American systems are rated for 120v/60Hz and 240v/60Hz power.
- Use double insulated or three-wire protected electrical appliances whenever possible.

1. Monitor the electrical control panel's polarity indicator lights on the AC panel:
  - a. • A *green* light illuminating after the power cord is plugged into the yacht's external power receptacle indicates acceptable electrical power in which you may energize the main breaker switches.
  - a. • A *red* light, however, indicates reversed polarity, which could cause electrical system damage and possibly electrical shock injuries. In this case, *do not* energize the main breaker switches.

**! WARNING!****SHOCK & ELECTRICAL SYSTEM DAMAGE HAZARD!**

- *You must monitor the polarity indicator lights every time you connect to shore power.*
- *When connecting to shore power and you encounter reversed polarity light (*red* colored), *do not* energize the main breaker switches. Instead, *immediately* disconnect the shore power cord (always from the dockside receptacle first) and notify marina management.*

2. Activate the AC system by turning the main ship/shore breaker to the shore position.
3. Turn on the master breaker and individual component breaker as required.

**NOTICE**

- *When using shore power, the simultaneous operation of several AC accessories can result in an overloaded circuit. It may be necessary to turn off one accessory while operating another.*
- Voltage on each line can be read by setting the voltmeter selector switch.
- Amperage draw can be read on the ammeter gauge.

**Shore Power Cable Hoist (Option)**

Your yacht may feature an **optional** cable hoist which allows you to easily feed out and reel in the shore power cable. We recommend that you read the cable hoist manual, included in your yacht's owner's packet.

1. Lift open the shore power inlet cover and locate the hoist switch (figure 1).
2. Turn *on* the hoist switch to feed the cable out (figure 2). When the desired length is reached, turn the switch off.
3. Plug the shore power cable into the external power receptacle (figure 3) and follow the directions given in the *Connecting to Shore Power* section on the previous page.
4. After disconnecting the shore power cable from the external power receptacle, use the hoist to retract the cable back onto the reel, making sure the cable doesn't fall into the water.

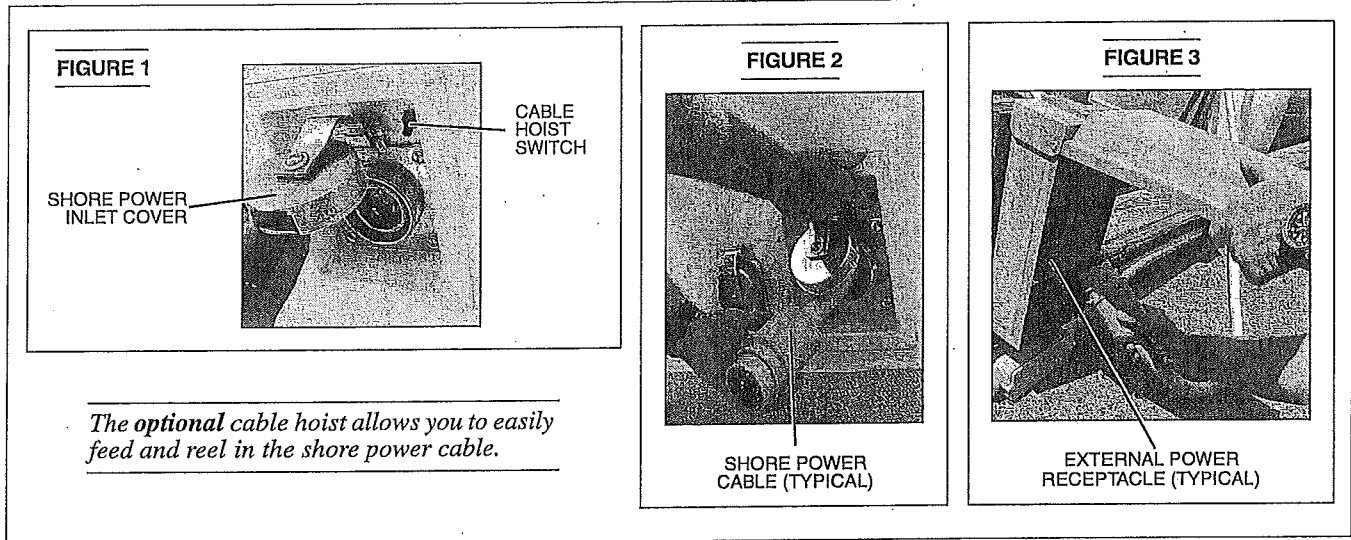

**Inverter Power (Option)**

Your yacht may feature an **optional** inverter, which is located on the aft engine room bulkhead. Refer to the inverter manual for detailed inverter operating procedures and observe the following:

- Activate the AC system under inverter power by switching *on* the inverter master breaker (located in the engine room on the bottom of the battery switch panel) and pressing the on/off switch on the inverter control panel (located on the inverter).
- The inverter only provides AC power to the accessories on the AC panel that have white breakers.

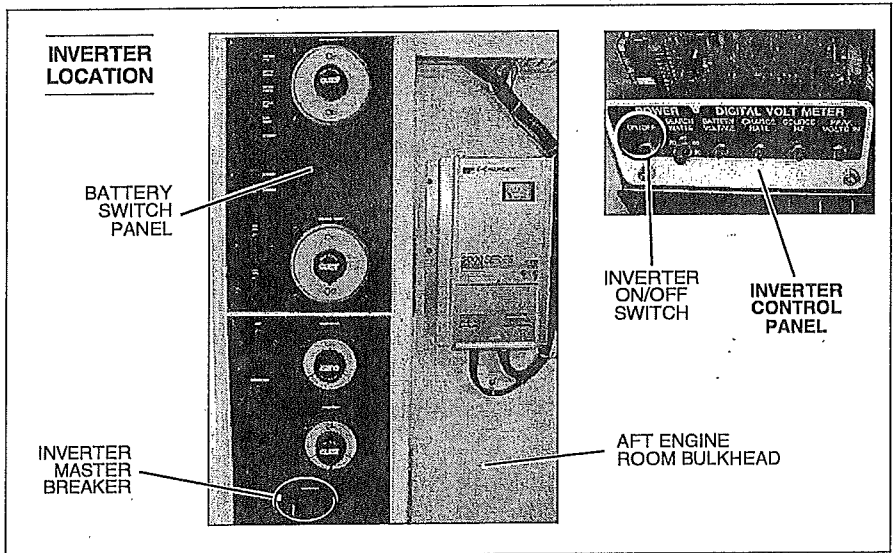

**Generator Power**

Your yacht is equipped with a main generator and may also feature an **optional** auxiliary generator. The generators are located in the generator compartment. Access to the generator compartment is through the aft cockpit hatches. Prior to initially operating your generator(s) we strongly urge you to read the generator operation manual(s) for pre-start checks and break-in procedures. The manuals are included in your yacht's owner's packet

Observe the following:

- Polarity has been established in the installation of the generator(s), therefore the polarity lights will not function in this mode.
- Fuel to run the main generator is supplied from the starboard fuel tank; fuel to run the auxiliary generator is supplied from the port fuel tank.
- In addition to servicing the filters attached to the generator(s), the filters/separators (located near the fuel line valves) should be serviced as described in the manufacturer's manual.
- The coolant mixture installed at the factory consists of equal parts of water and antifreeze (Ethylene Glycol). The coolant bottle for the main generator is located on the forward bulkhead in the generator compartment; the coolant bottle for the auxiliary generator is located on the port side of the generator compartment.
- Frequently check each generator's seawater strainer for leaks and/or debris.
- Oil pressure, water temperature, and voltage gauges are provided on the AC panel. These gauges monitor the engine functions of your generator(s).

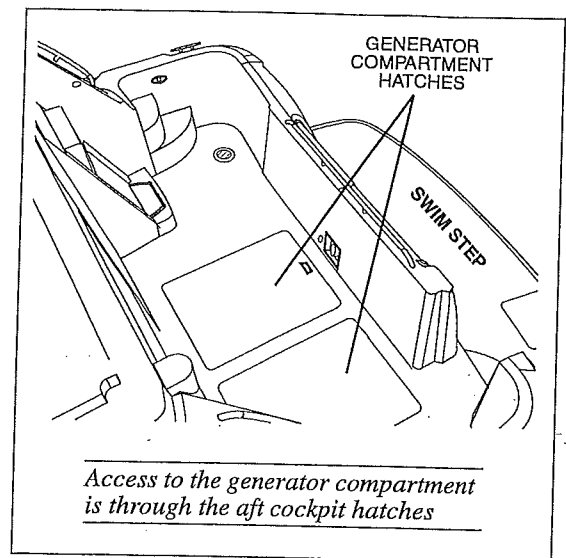

### Main Generator

Starting the main generator:

1. Open the main generator's seacock valve before starting the generator and keep the seacock valve open during generator operation.
2. Operate the bilge blowers for a minimum of four minutes before starting the generator. Leave the blowers on while the generator is operating unless running your yacht at cruising speed.
3. Verify that the generator's battery switch, located in the generator compartment, is turned *on*.
4. On the AC panel, press and *hold* the preheat switch *on* for one minute for preheating.
5. While holding the generator's preheat switch, press the start button. As the engine starts, continue to hold the preheat switch until oil pressure is indicated on the pressure gauge.

### NOTICE

**Never operate the starter for more than 30 seconds. If the generator does not start, wait at least 30 seconds before another start attempt is made.**

6. On the 240v AC panel (below the AC generator panel), slide the T-bar left (from shore to generator power). To activate the AC system under generator power, switch the generator master circuit breaker *on*, then activate each individual component breaker as required.
  7. To monitor the voltage generated by the generator, switch the shore/generator voltage switch to *generator*.
- To shut off the main generator: Hold the "off" switch until the generator shuts down.

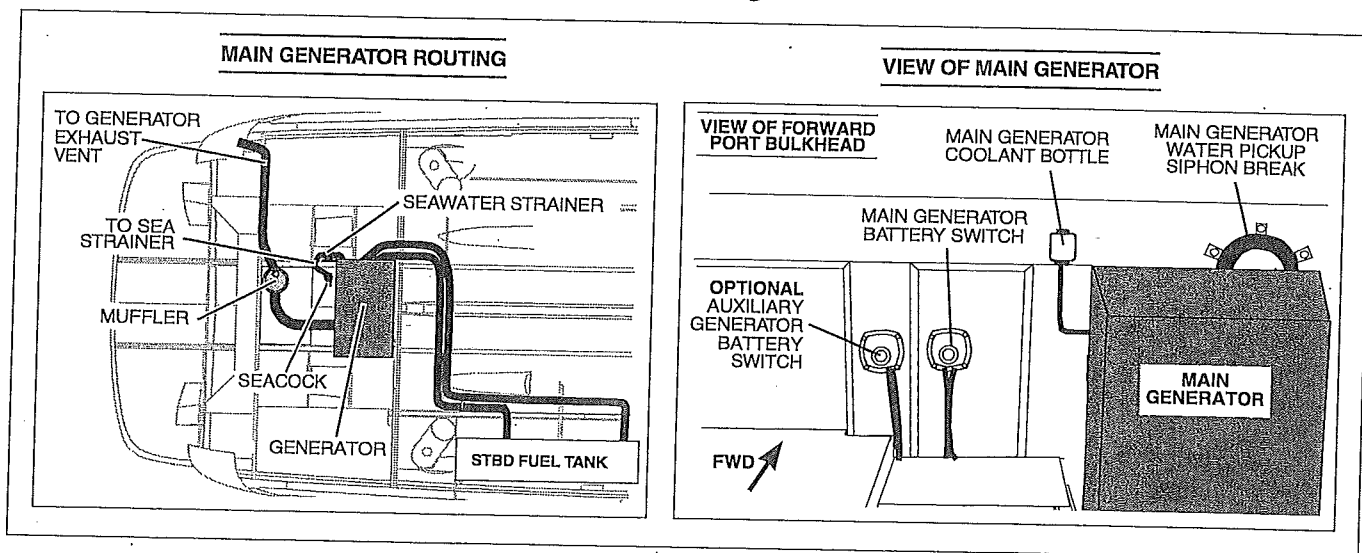

**Auxiliary Generator (Option)**

*Starting the auxiliary generator:*

1. Open the auxiliary generator's seacock valve before starting the auxiliary generator. The seacock must remain open during generator operation.
2. Operate the bilge blowers for a minimum of four minutes before starting the generator. Leave the blowers on while the generator is operating unless running your yacht at cruising speed.
3. Verify that the generator's battery switch, located in the generator compartment, is turned on before attempting to start the generator.
4. On the auxiliary generator's display panel, located on the AC panel, press the generator's "on" button.
5. Push and hold the generator preheat switch for approximately 30 seconds.
6. Release the preheat switch and push the start button until the AC light illuminates on the AC panel.

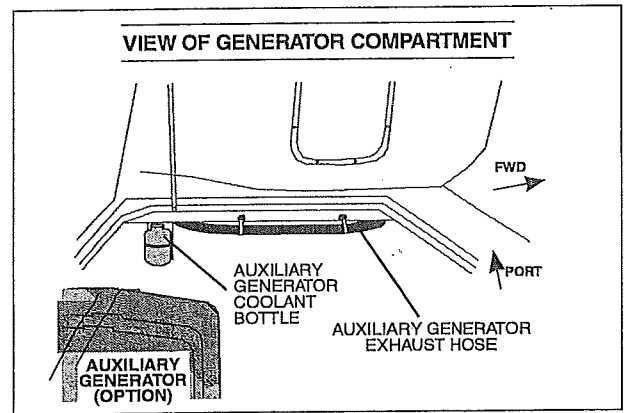
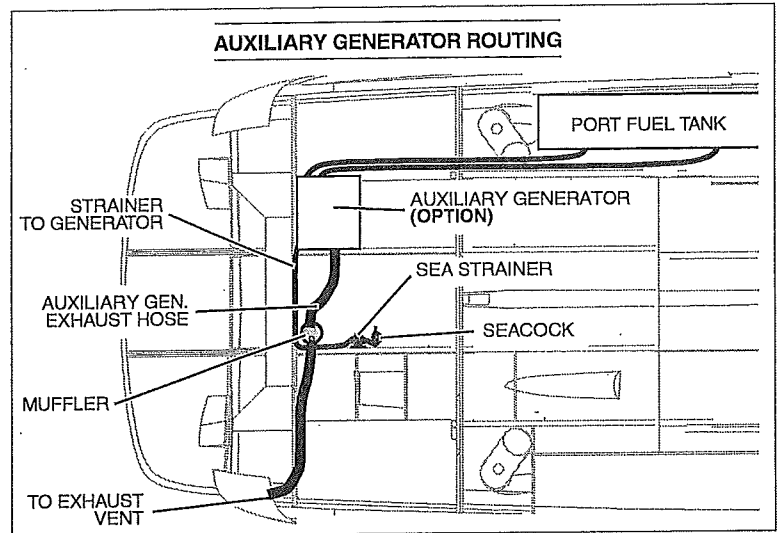

**NOTICE**

**Never operate the starter for more than 30 seconds. If the generator does not start, wait at least 30 seconds before another start attempt is made.**

7. Switch the selector switch to auxiliary generator power. The green AC light, located above the main generator breaker, should illuminate.
8. On the 240v AC panel (below the AC generator panel), slide the T-bar left (from shore to generator power). To activate the AC system under generator power, switch the generator master circuit breaker *on*, then activate each individual component breaker as required.
9. To show the voltage generated by the generator, switch the shore/generator voltage switch to *generator*.

To shut off the auxiliary generator: Hold the "off" switch until the generator shuts down.

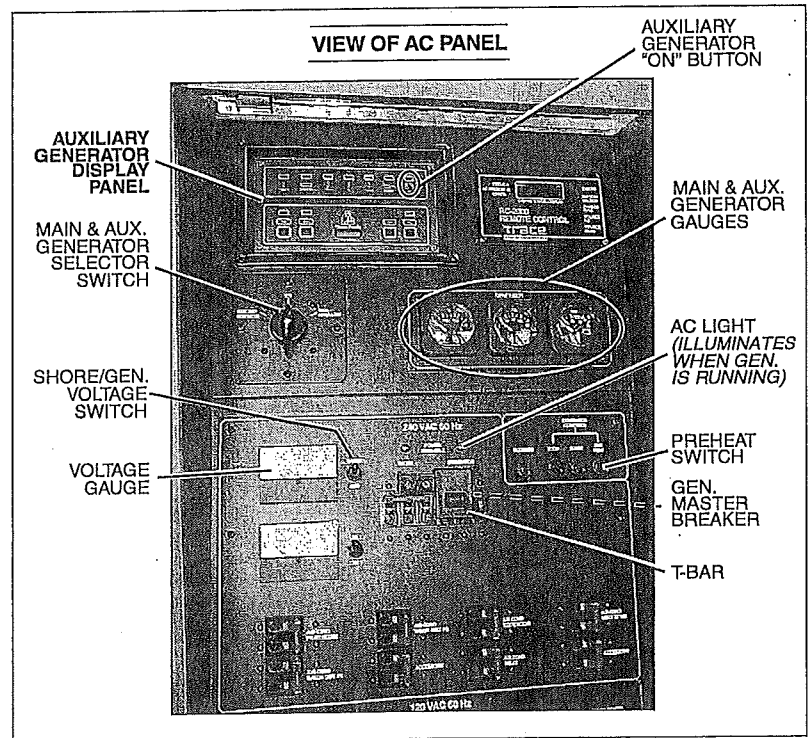

# Electrical Routing

## Routing Key

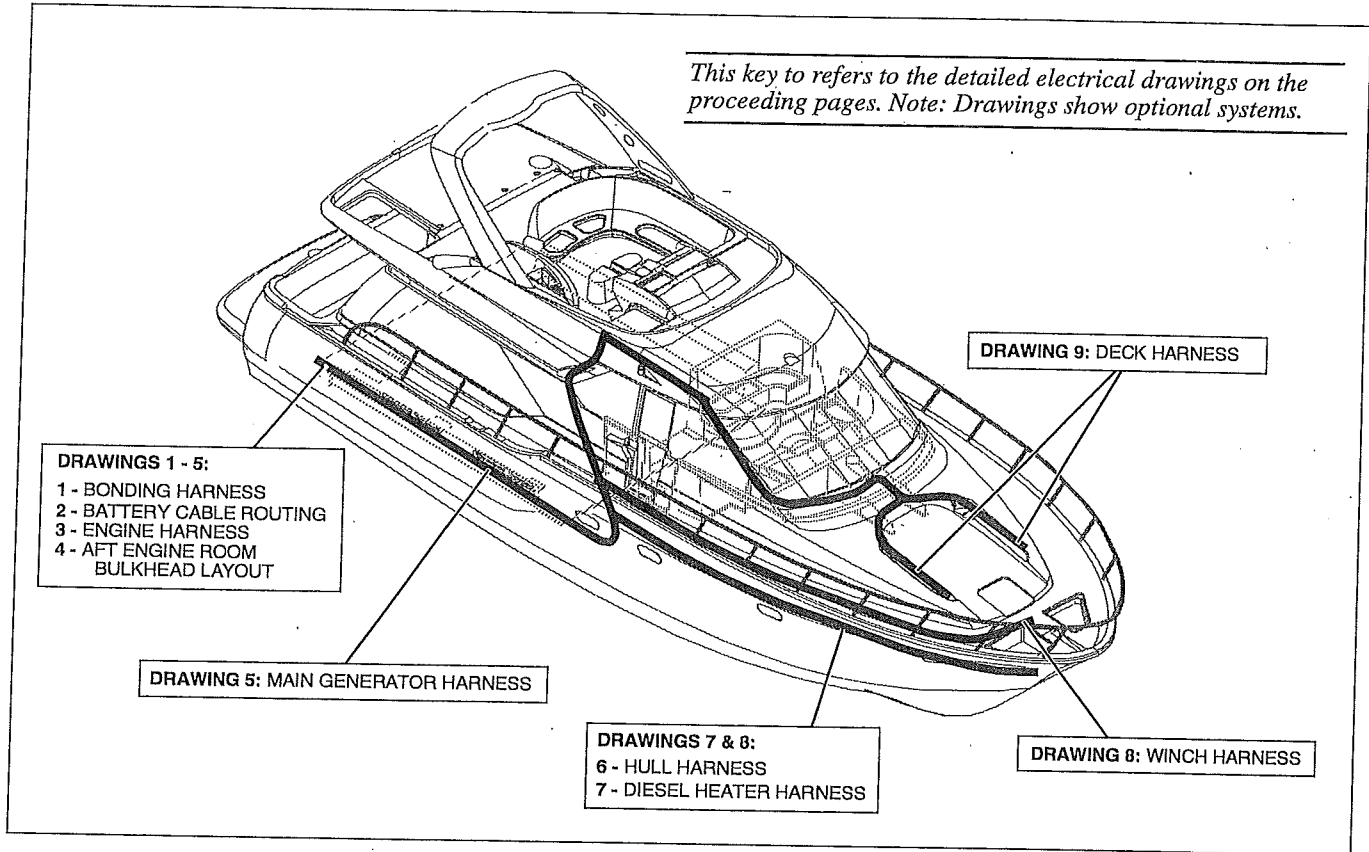

### Drawing 1: Bonding Harness

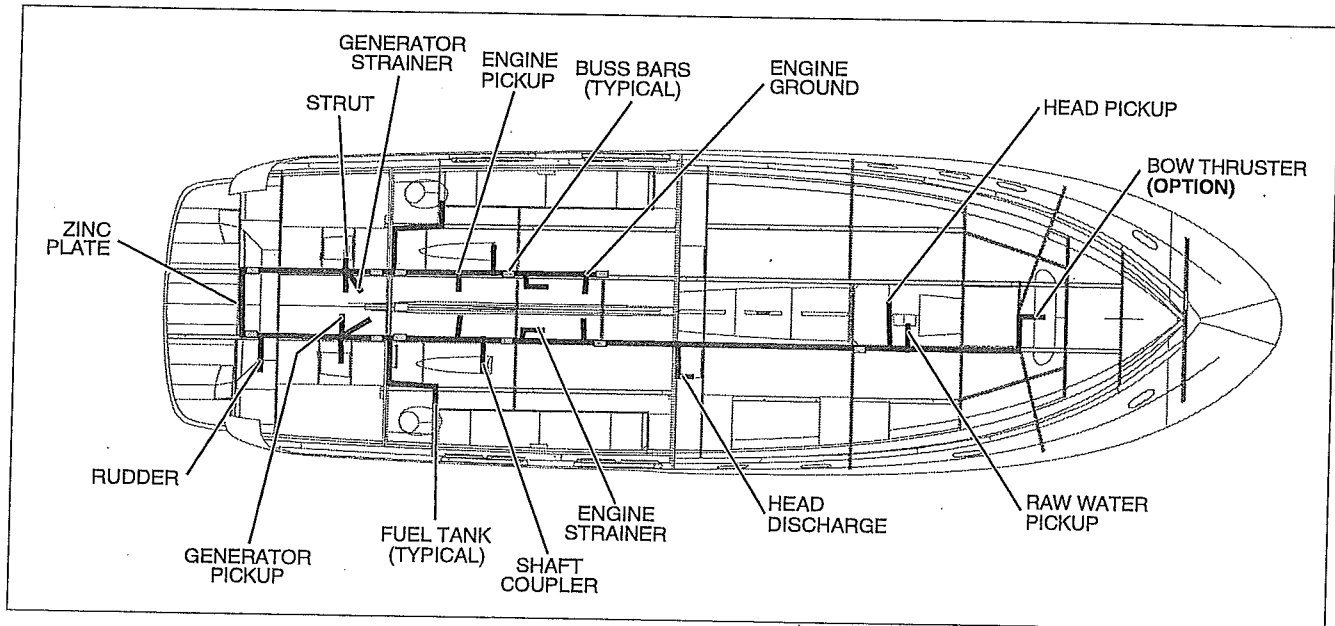

**Drawing 2: Battery Cable Routing**

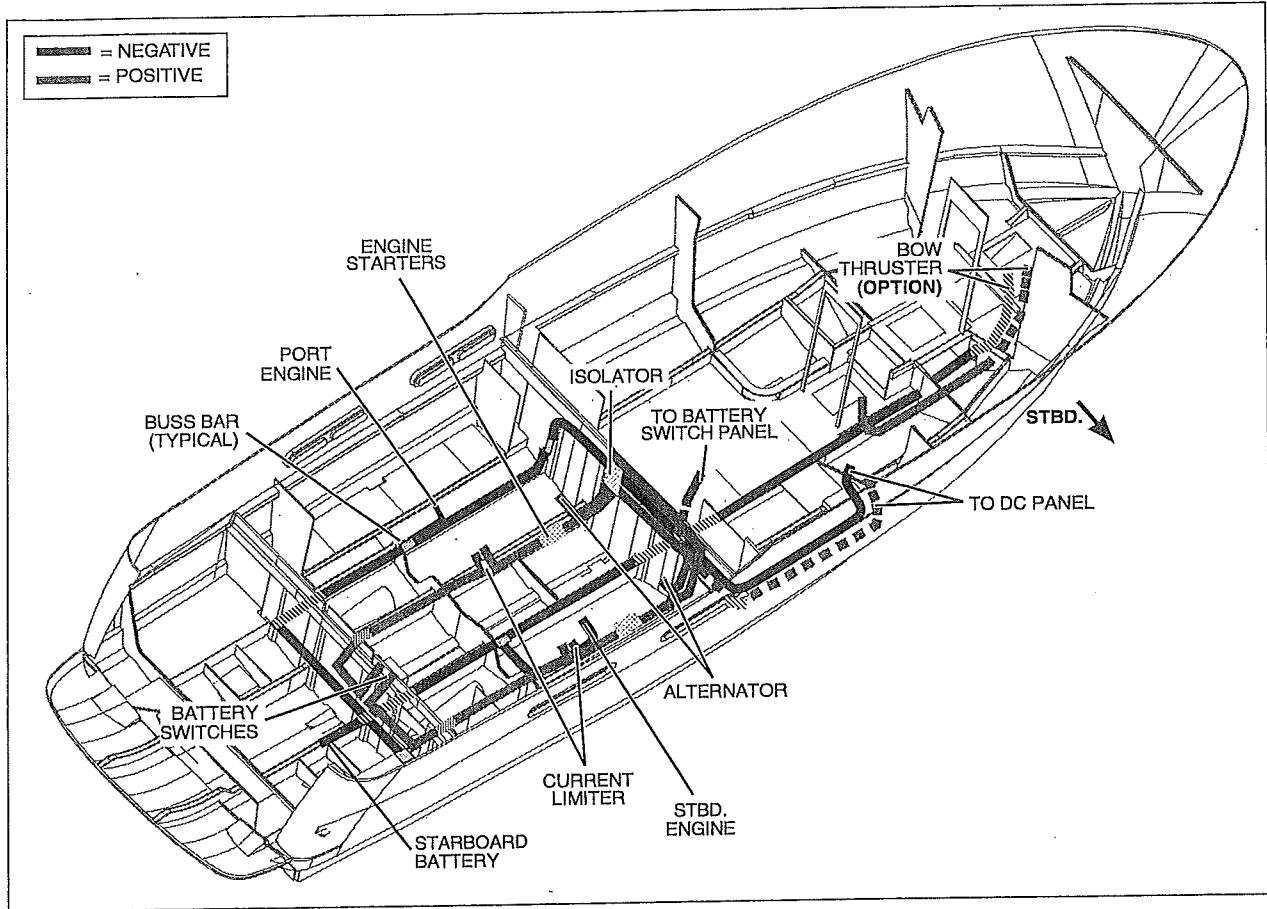

**Drawing 3: Engine Harness**

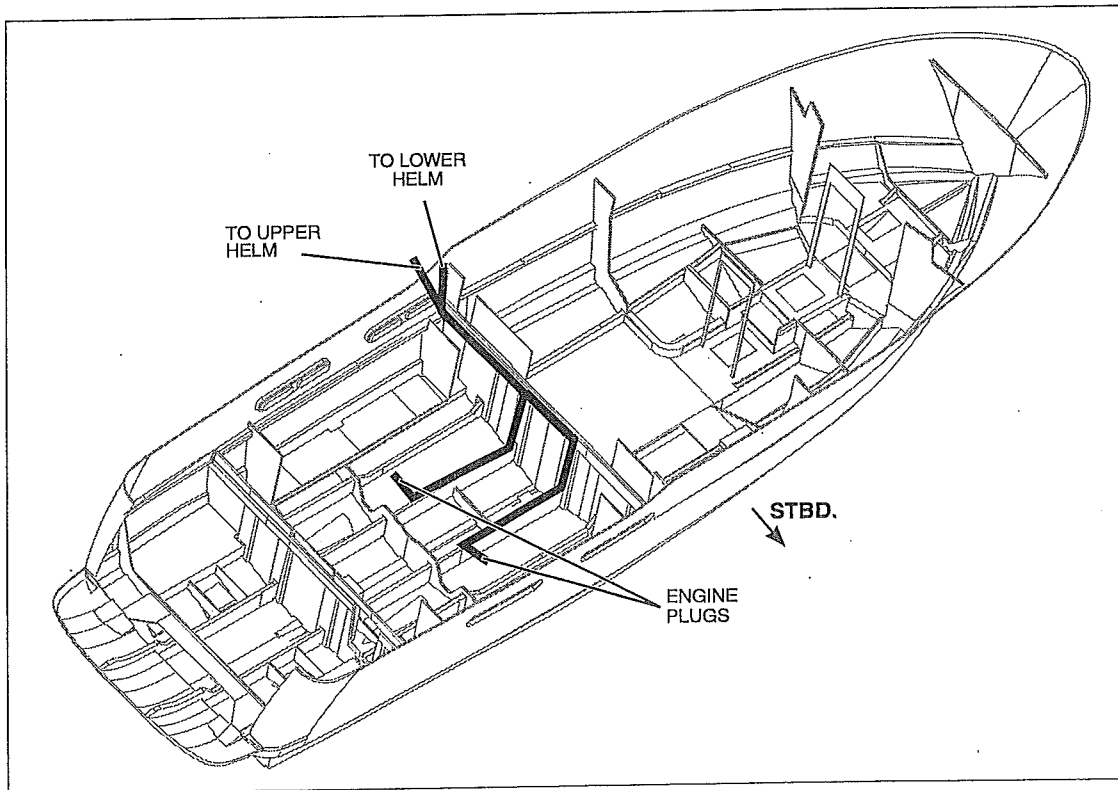



**Drawing 4: Aft Engine Room Bulkhead**

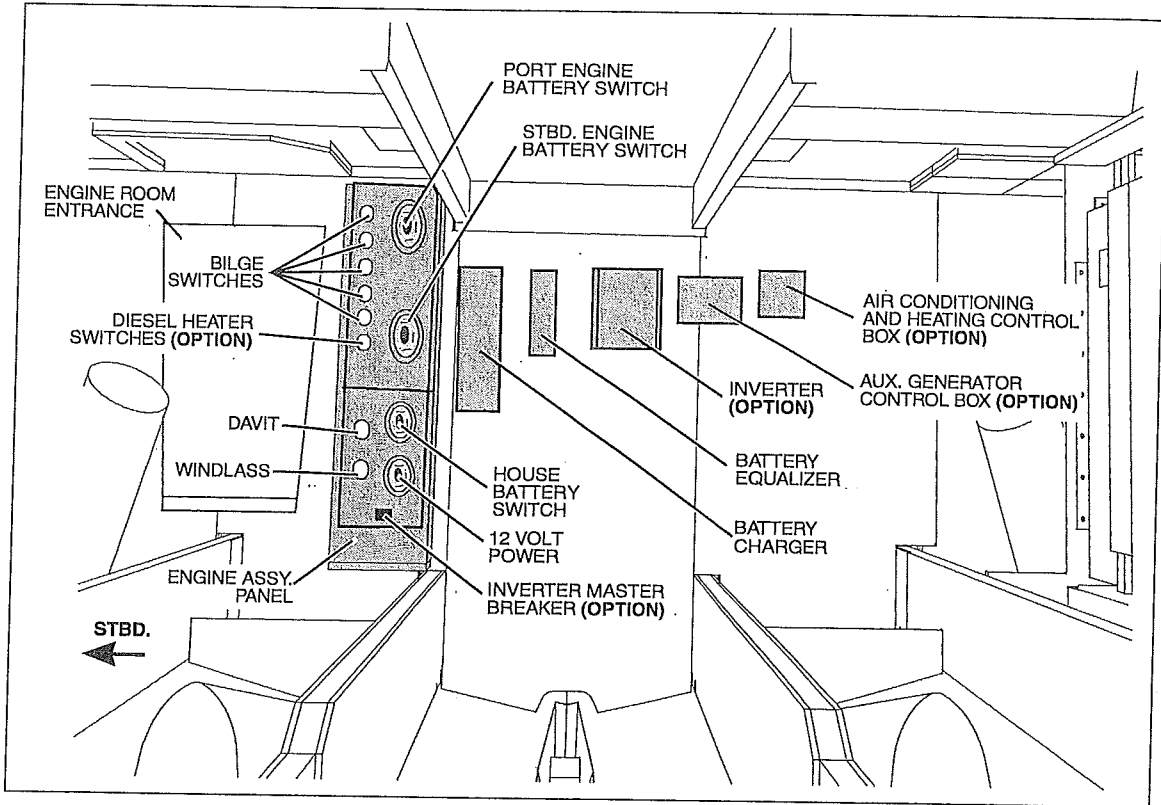

**Drawing 5: Main Generator Harness**

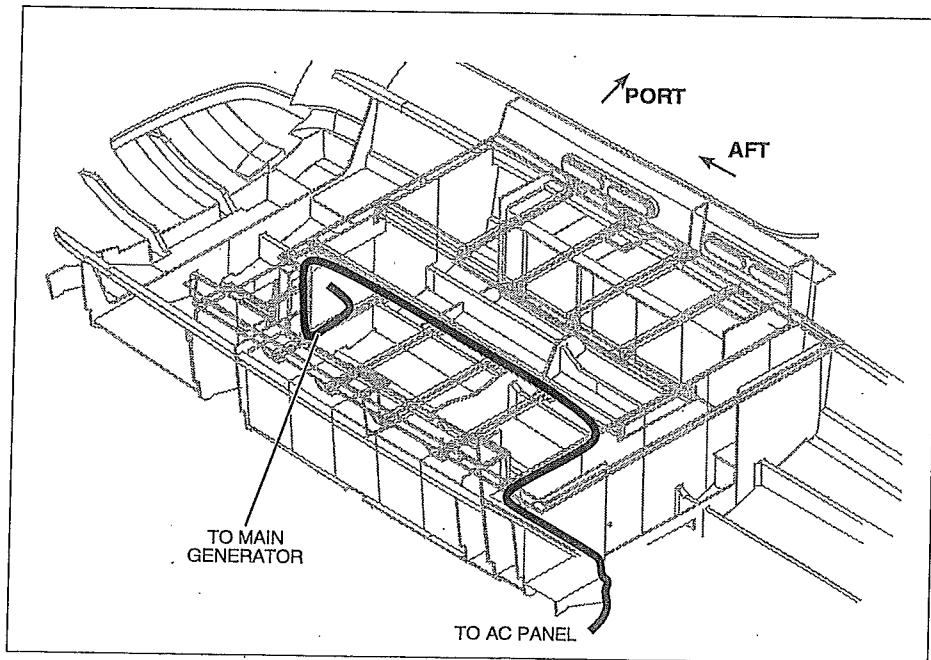

**Drawing 6: Hull Harness**

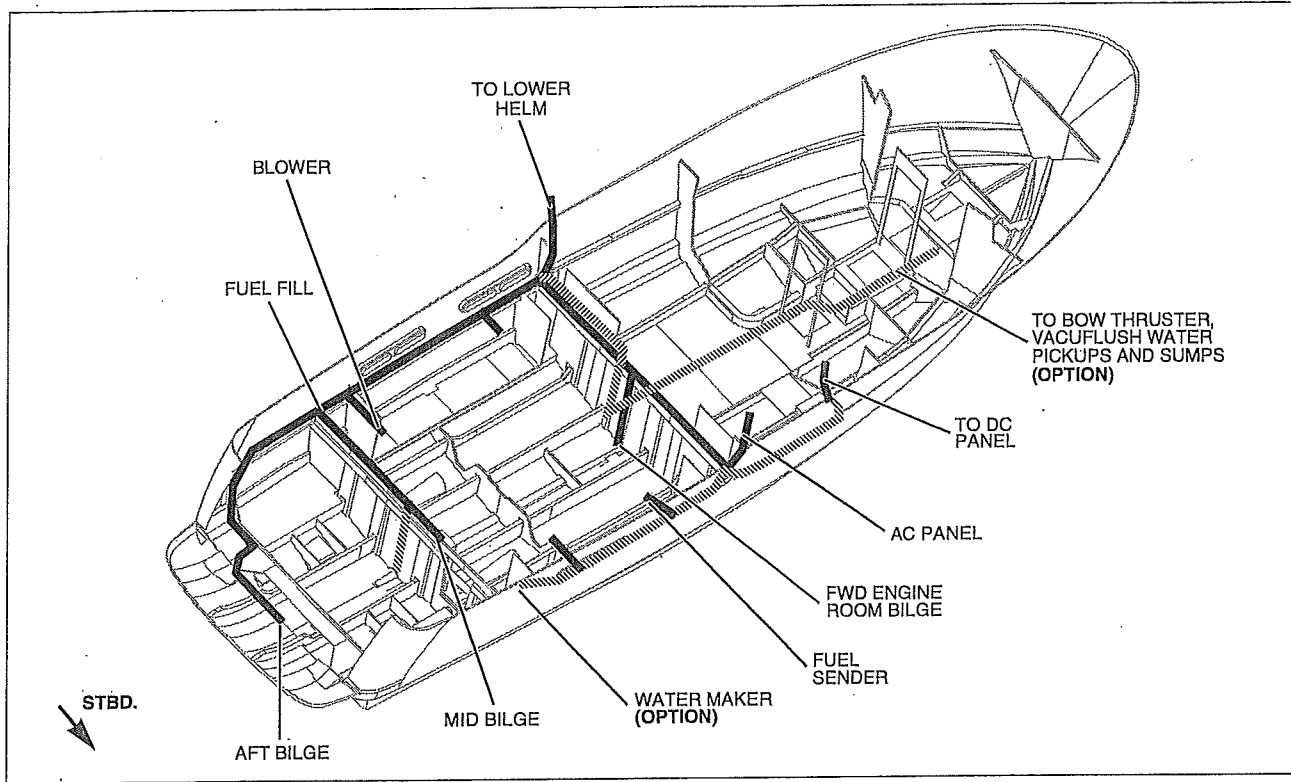

**Drawing 7: Diesel Heater Harness (Option)**

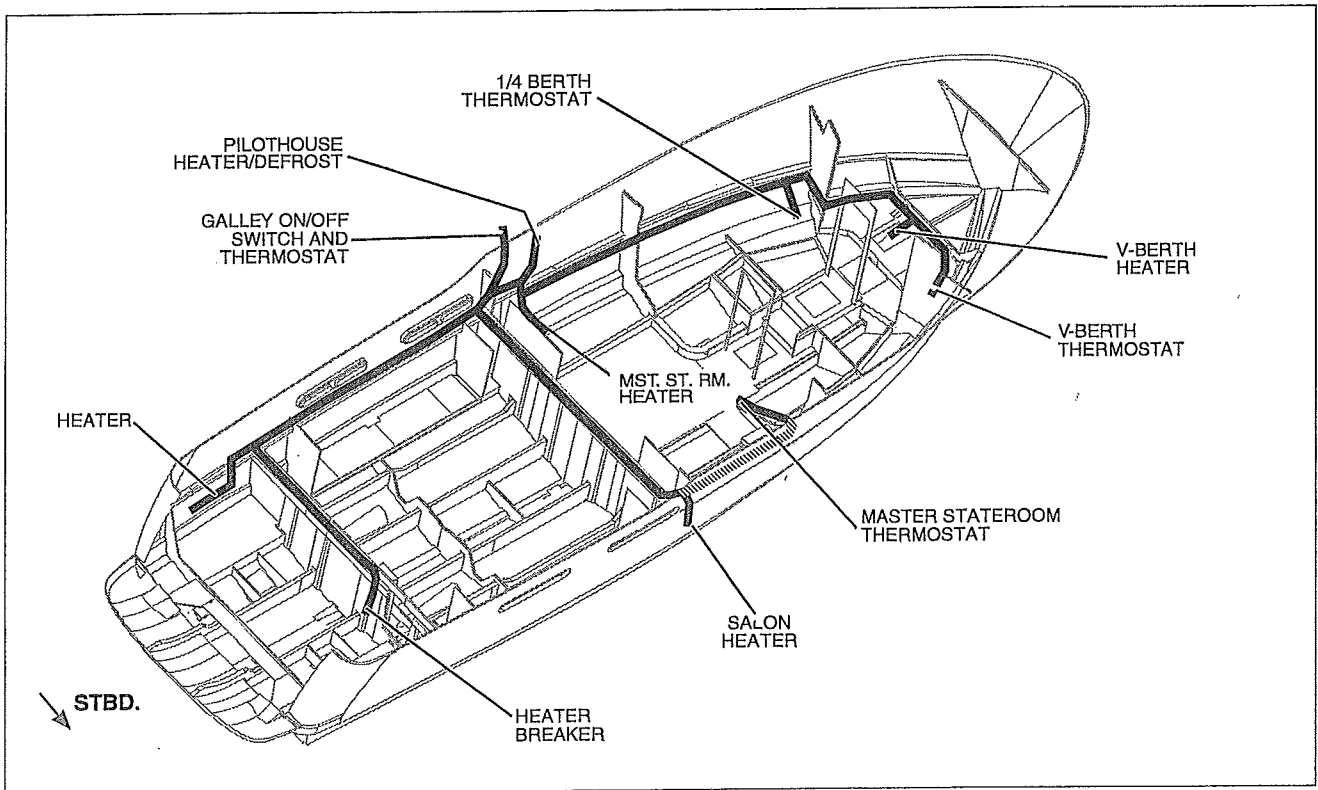

**Drawing 8: Winch Harness**

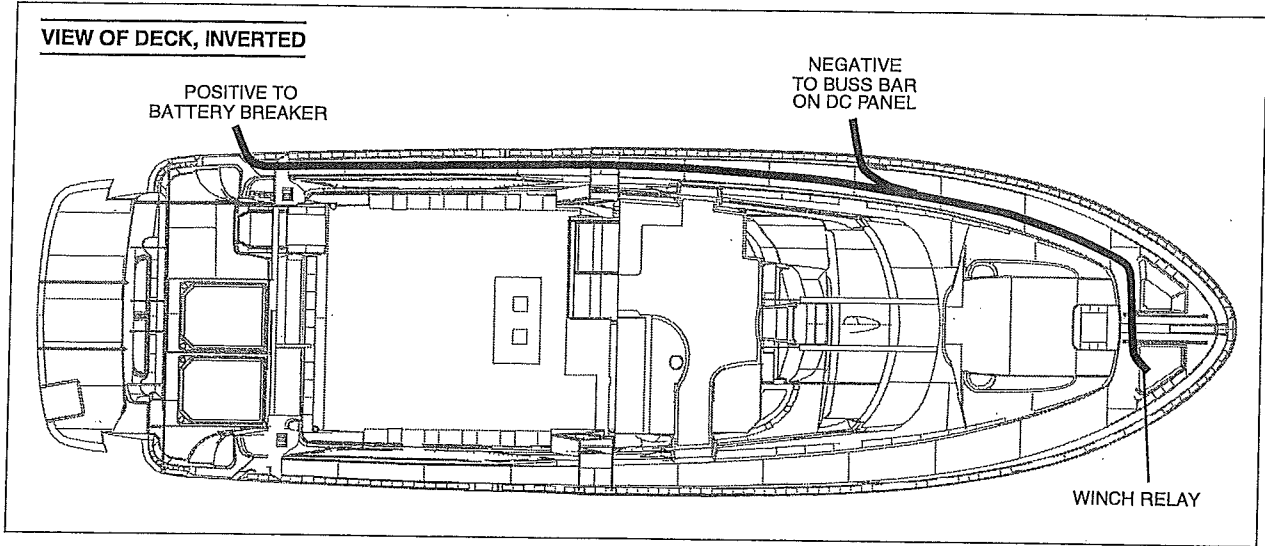



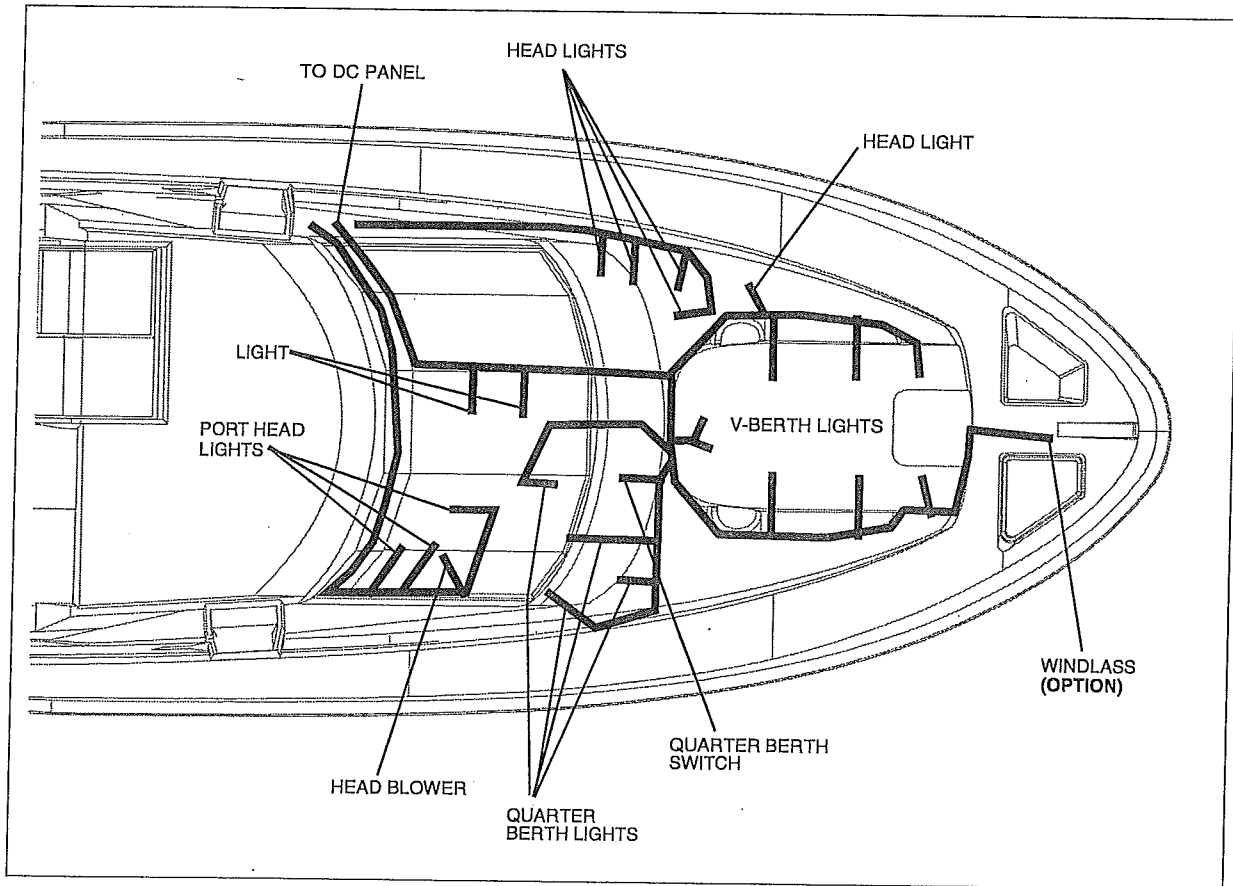















**Drawing 9: Deck Harness**



## Wiring Schematics

### Electrical Symbol Key

Symbol	Description	Symbol	Description
	Connection (Node)		Fuel Sender
	No Connection		Bulb
	Battery		Diode
	Earth Ground: <i>Represents black conductor of nominal size compared to colored conductor</i>		12V DC Receptacle
	Plug		Motor/Pump
	Breaker		Gauge
	Fuse		Speaker/Horn/Alarm
	Switch: <i>Single Pole Single Throw (SPST)</i>		Float Switch
	Switch: <i>Double Pole Single Throw (DPST)</i>		Lighted Switch: <i>Single Pole Single Throw (SPST)</i>

### Wire Color Key

Color Key	Description	Color key	Description
BLK or B	Black	BL or BLU	Blue
BR or BRN	Brown	DK	Dark
DK	Dark	GY or GRY	Gray
GR	Green	LT	Light
O or ORG	Orange	PK	Pink
PU, PUR or PPL	Purple	R or RED	Red
T or TAN	Tan	W or WH	White
Y or YEL	Yellow		

## NOTICE

- Wiring diagrams show *optional* equipment not installed on all models.
- Some yachts may come equipped with silver (-) and copper (+) colored speaker wires or red/black (-) and red/white (+) wire colors for port speakers; green/black (-) and green/white (+) colors for starboard speakers.

Engine Harness

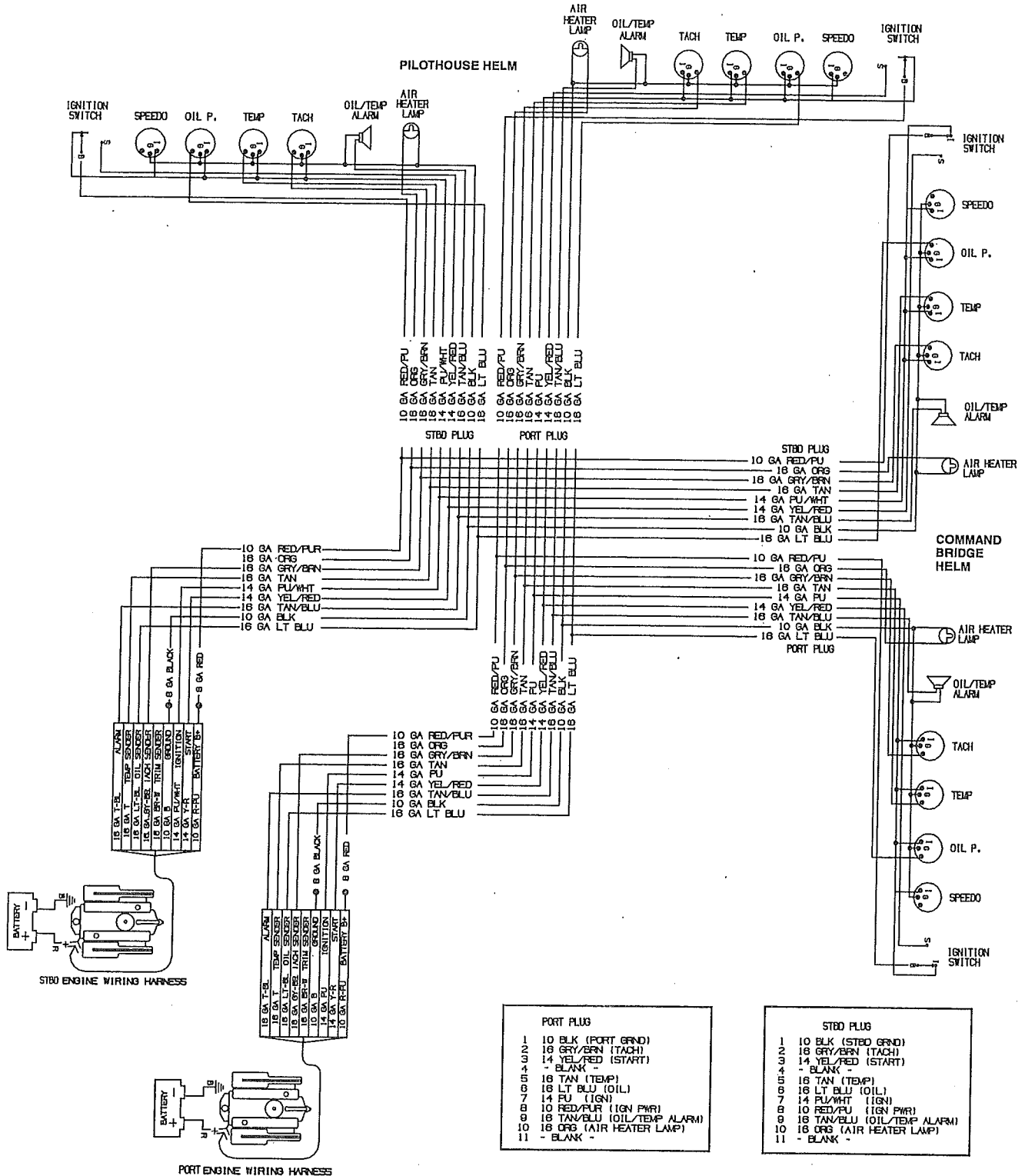

Hull Harness

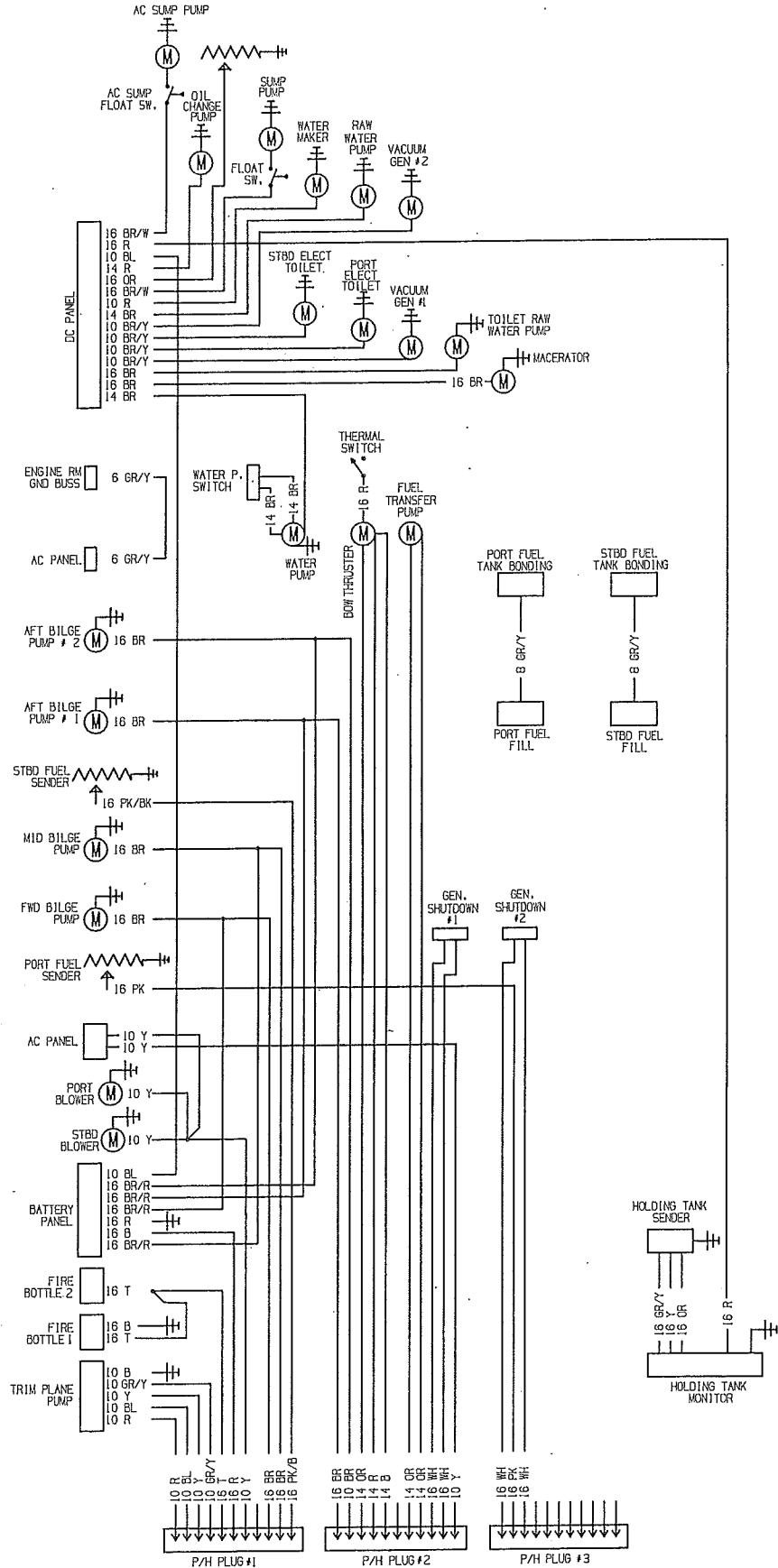

**Dockside AC Harness**

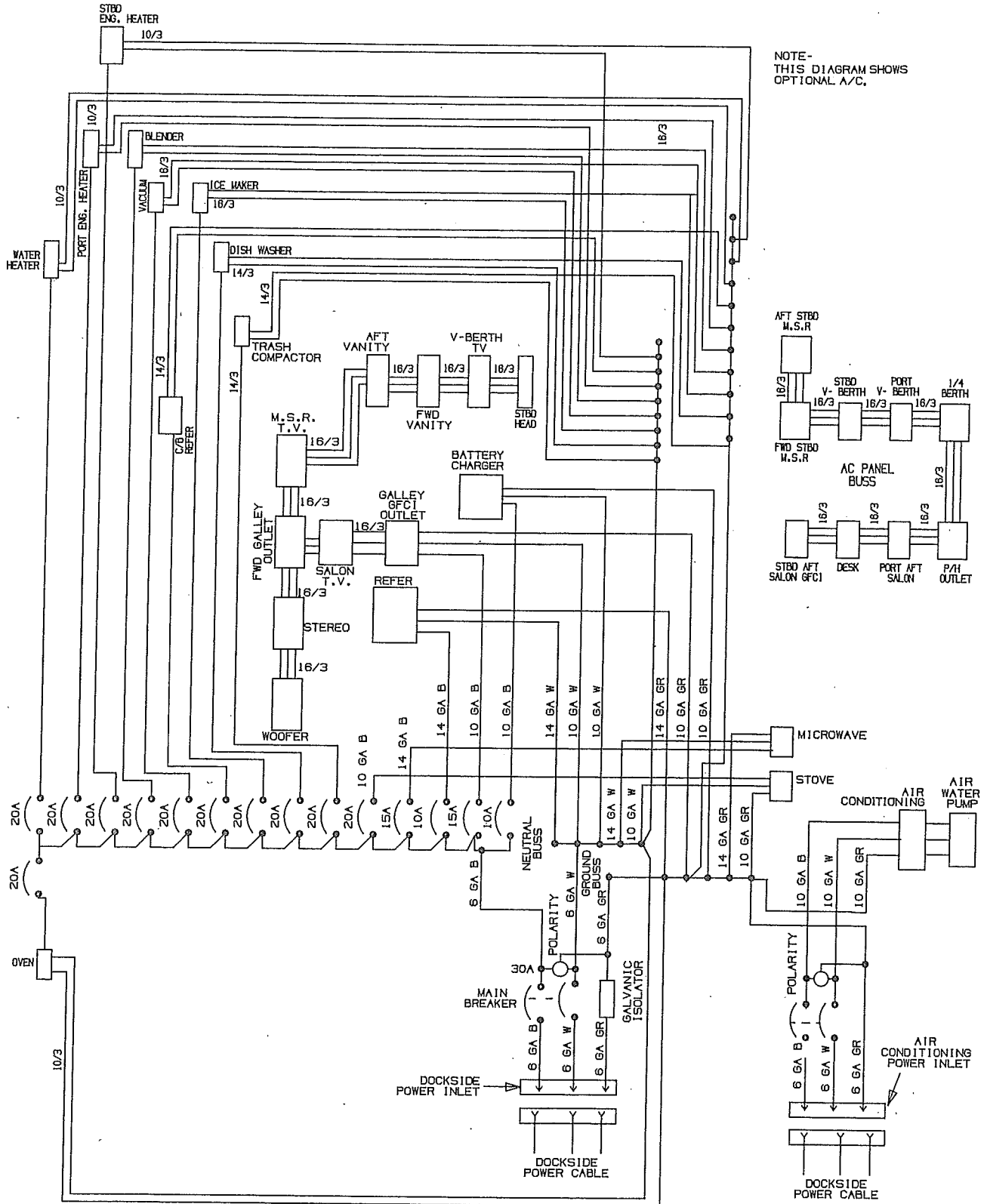

Pilothouse Harness

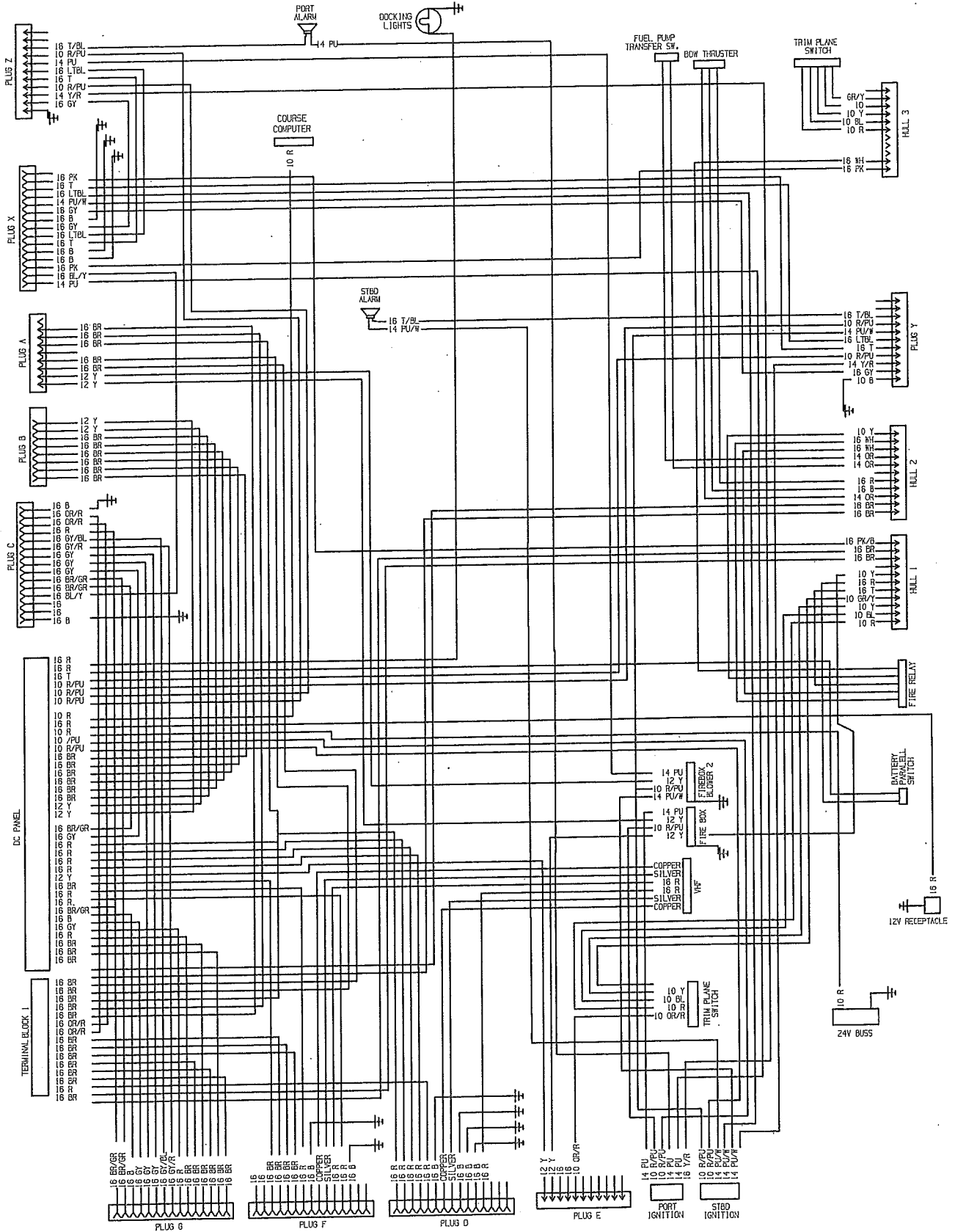



**Pilothouse Connector**

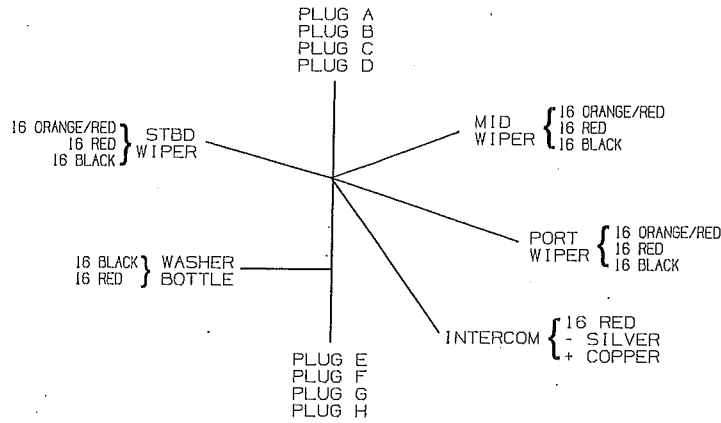

**Salon Harness**

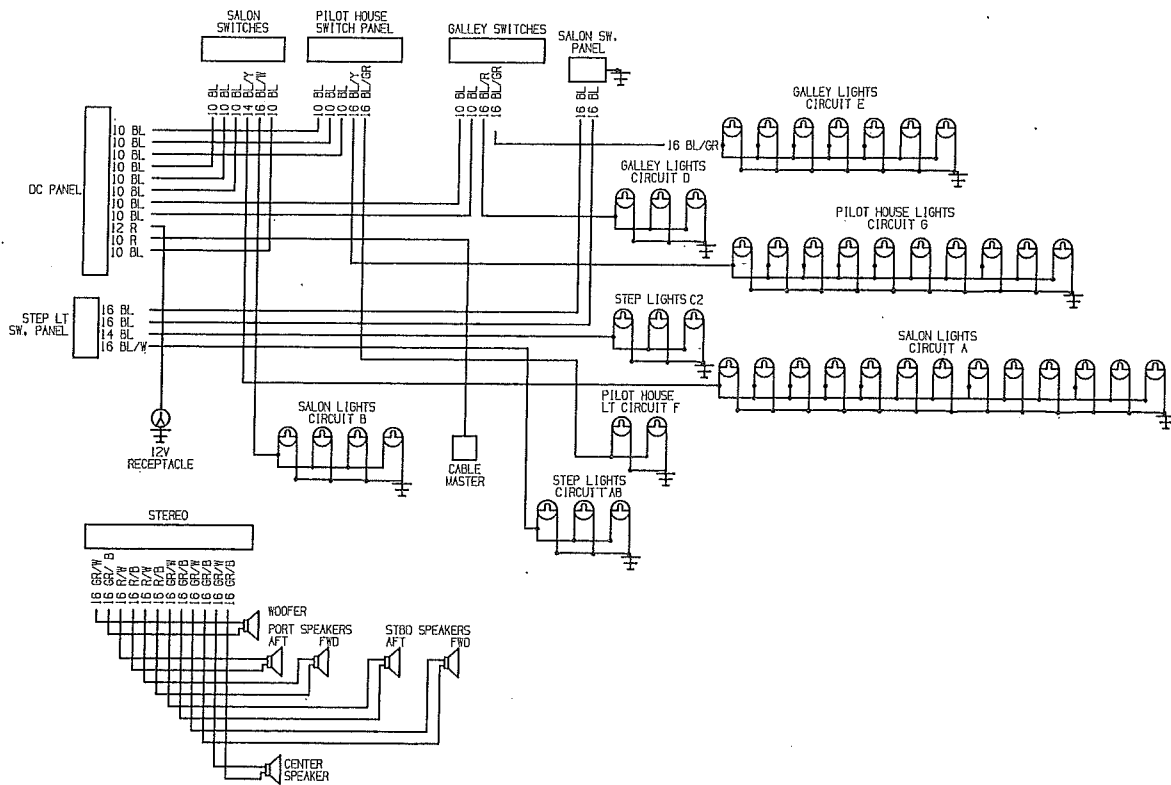

**Arch Harness**

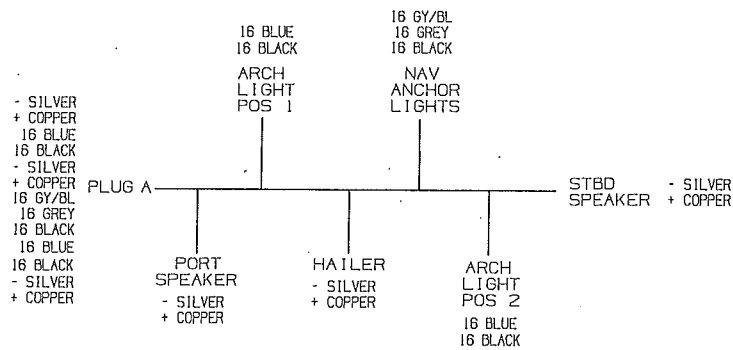

**V-Berth Harness**

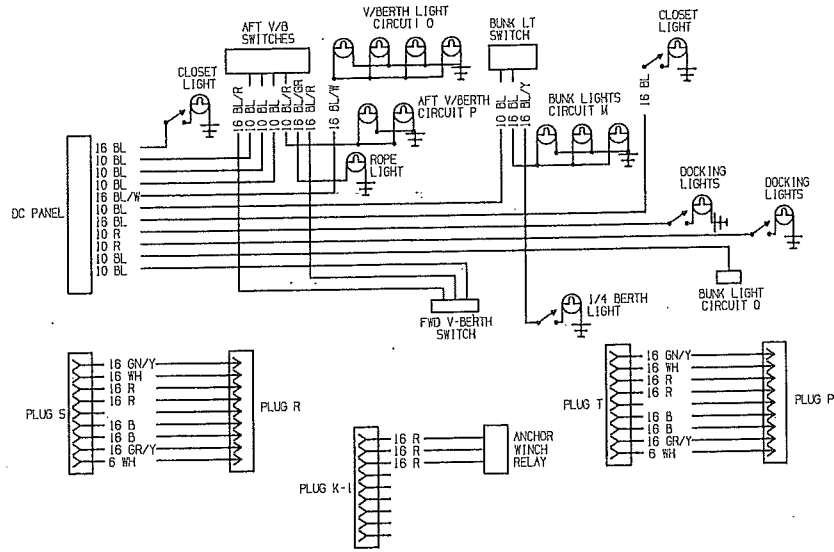

**Diesel Heater (Option)**

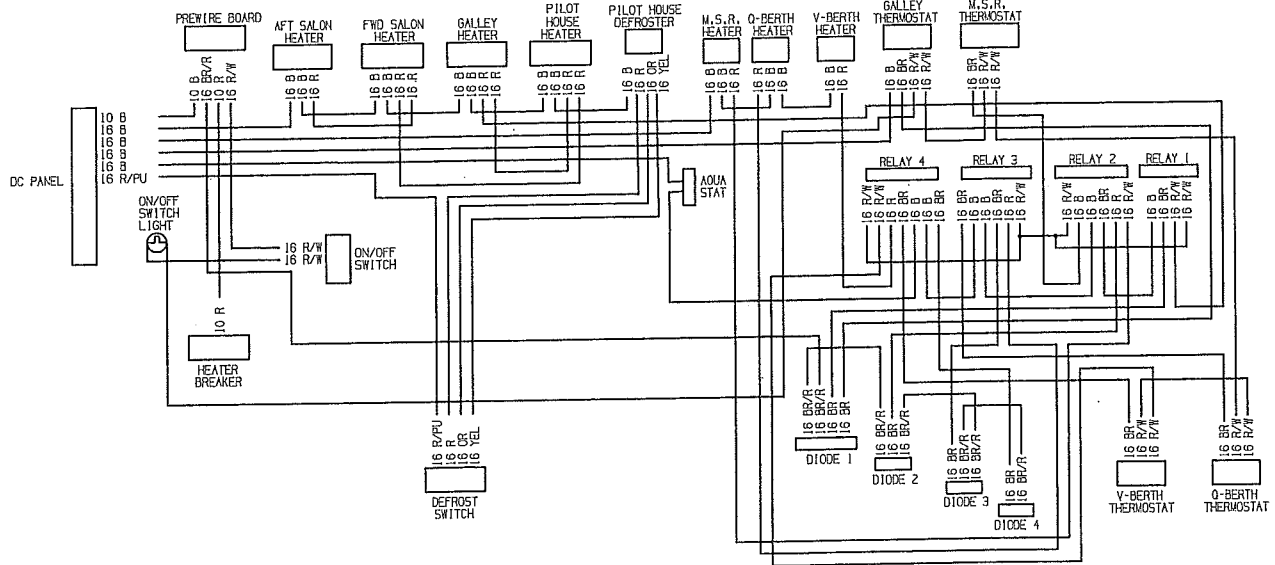

**Command Bridge Harness**

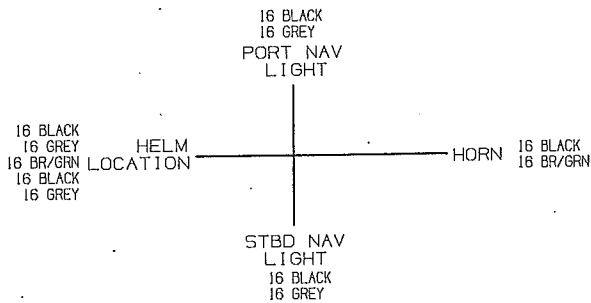



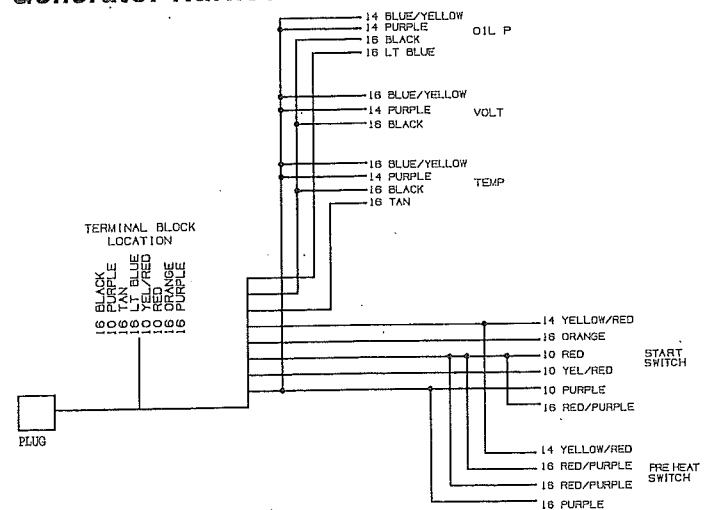









































**Generator Harness**



## APPENDIX A: ISO SYMBOLS

These ISO symbols may be used throughout your yacht, the Owner's Manual and this Owner's Manual Supplement to identify and describe various systems and components.

Symbol	Description	Symbol	Description	Symbol	Description
	Air Cooled Charge Air Cooler		Air, General		Air, Intake (For Combustion)
	Anchor		Blower		Compass
	Counterclockwise Rotation		Crankshaft Power		Disengage
	Elapsed Time		Electric Generator		Electrical Preheat for Diesel Engine
	Engage		Engine		Engine Air Intake
	Engine Coolant		Engine Exhaust Gas		Engine Exhaust Gas Pressure
	Engine Exhaust Gas Temperature		Engine Inlet Air Filter		Engine Inlet Air Pressure
	Engine Inlet Air Temperature		Engine Oil		Engine Oil Filter
	Engine Oil Level		Engine Oil Pressure		Engine Oil Temperature
	Engine Rotation Speed, R/MIN		Engine Start		Engine Water Jacket Drain
	Exhaust Gas		Filter		Freshwater
	Freshwater Cooled Charged Air		Freshwater Tank		Fuel, Diesel
	Fuel Filter		Fuel General		Fuel Level
	Fuel, Liquid Propane Gas		Fuel Shut Off		Fuel Tank, Diesel
	Fuel Tank, LPG		Fuel Tank, Unleaded		Fuel, Unleaded

Symbol	Description	Symbol	Description	Symbol	Description
	Heat Exchanger		Holding Tank		Horn
	Hydraulic Oil		Hydraulic Oil Filter		Hydraulic Oil Level
	Hydraulic Oil Pressure		Hydraulic Oil Temperature		Hydraulic System
	Hydraulic System Malfunction		Interior Light		Lift Point
	Light		Lubricating Oil		Malfunction
	No Open Flame		Oil Tank		Outboard Drive
	Outboard Drive Tilt		Pressure		Propeller
	Propshaft Power		Propulsion System Trim		Propulsion System Trim, Bow Down
	Propulsion System Trim, Bow Up		Pump		Read Owner's Manual
	Seawater		Shift Only Fwd-N-Rev		Sling Location
	Tank		Throttle/Shift		Transmission
	Transmission Oil		Transmission Oil Filter		Transmission Oil Level
	Transmission Oil Malfunction		Transmission Oil Pressure		Transmission Oil Temperature
	Trim Tab Operation		Trim Tab Operation, Bow Down		Trim Tab Operation, Bow Up
	Volume Empty		Volume Full		Volume Half Full
	Warning		Warning Electrical Hazard		Warning Fire Risk
	Warning Hot		Waste Water, Sewage		Water Flushing Connector
	Windshield Washer Tank		Windshield Wiper & Washer		

## **APPENDIX B: LIMITED WARRANTY**

---

Bayliner warrants to the original purchasers of its 1999 and 2000 model boats, purchased from an authorized dealer, operated under normal, noncommercial use that the selling dealer will: (A) Repair any structural hull defect which occurs within five (5) years of the date of delivery; and (B) Repair or replace any parts found to be defective in factory material or workmanship within one (1) year of the date of delivery.

### **What Is Not Covered**

This limited warranty does not apply to:

1. Engines, drive trains, controls, props, batteries, or other equipment or accessories carrying their own individual warranties;
2. Engines, parts or accessories not installed by Bayliner;
3. Plexiglass windscreen breakage; rainwater leakage on runabout models; rainwater leakage through convertible tops; minor gelcoat discoloration, cracks or crazing or air voids;
4. Hull blisters that form below the waterline;
5. Normal deterioration, i.e. wear, tear, or corrosion of hardware, vinyl, tops, vinyl and fabric upholstery, plastic, metal, wood, or trim tape;
6. Any Bayliner boat used for commercial purposes;
7. Any defect caused by failure of the customer to provide reasonable care and maintenance.

### **Other Limitations**

THERE ARE NO OTHER EXPRESS WARRANTIES ON THIS BOAT. TO THE EXTENT ALLOWED BY LAW:

1. ANY IMPLIED WARRANTY OF MERCHANTABILITY OR FITNESS FOR A PARTICULAR PURPOSE IS LIMITED TO THE DURATION OF ONE YEAR.
2. Neither Bayliner nor the selling dealer shall have any responsibility for loss of use of the boat, loss of time, inconvenience, commercial loss or consequential damages.
3. Some jurisdictions do not allow limitations on how long any implied warranty lasts, so the above limitation may not apply to you. Some jurisdictions do not allow the exclusion or limitation of incidental or consequential damages, so the above limitation or exclusion may not apply to you. This limited warranty gives you specific legal rights, and you may also have other rights which vary from state to state.

### **Your Obligation**

In order to comply with regulations, it is essential that your limited warranty registration card be submitted within 30 days of delivery of your boat. Return of the limited warranty registration card is a condition precedent to limited warranty coverage. Before any warranty work is performed, we require that you contact your dealer to request warranty assistance.

**YOU MUST GIVE US WRITTEN NOTICE OF YOUR WARRANTY CLAIM PRIOR TO THE EXPIRATION OF YOUR LIMITED WARRANTY AND ALLOW US AN OPPORTUNITY TO RESOLVE THE MATTER.**

We require that you return your boat, at your expense, to your selling dealer or, if necessary, to the Bayliner factory. You will be responsible for all transportation, haulouts and other expenses incurred in returning the boat for warranty service.

### **Bayliner Marine Corporation**

PO Box 9029  
Everett, WA 98206

Phone: 360-435-8957  
FAX: 360-403-4235

