

# *3258 Avanti*

---

*1996 OWNER'S MANUAL*



**BAYLINER<sup>®</sup>**

Putting Quality First

The hazard warning symbols shown below are used throughout this manual to call attention to potentially dangerous situations which could lead to either personal injury or product damage. We urge you to read these warnings carefully and follow all safety recommendations.

**⚠ DANGER**

The symbol shown above alerts you to immediate hazards which **WILL** cause *severe personal injury or death* if the warning is ignored.

**⚠ WARNING**

The symbol shown above alerts you to hazards or unsafe practices which **COULD** result in *severe personal injury or death* if the warning is ignored.

**⚠ CAUTION**

The symbol shown above alerts you to hazards or unsafe practices which **COULD** result in *minor personal injury, or cause product or property damage* if the warning is ignored.

**NOTICE**

The symbol shown above calls attention to installation, operation or maintenance information which is important to proper operation, but is not hazard-related.

**⚠ WARNING**

**A qualified operator must be in control of the boat at all times. Do not operate your boat while under the influence of alcohol or drugs. Never operate your boat at speeds which exceed your ability to react if an emergency develops. At night, turn on the appropriate running lights and cruise at a reduced speed that will allow you plenty of time to avoid dangerous situations.**

**⚠ WARNING**

**Manufactured with 1,1,1-Trichloroethane, a substance which harms public health and environment by destroying ozone in the upper atmosphere.**

## WELCOME ABOARD

This manual has been prepared to assist you in the operation and care of your **Bayliner Avanti 3258**. Please read through it completely, as familiarization with its contents can contribute to the safe and effective operation of your boat.

Your boat's engines and accessories were selected to provide optimum performance and utility. Installation of different engines or other accessories may cause undesirable handling characteristics. Should you choose to install different engines, or to add accessories that will affect the boat's running trim, have an experienced marine technician perform a safety inspection and a handling test before operating your boat by yourself again.

Your boat's mechanical and electrical systems were designed to meet safety standards in effect at the time it was constructed. Some of these standards were mandated by Federal law, others are considered industry norms. All of them were designed to insure your safety, and the safety of other people, vessels and property around you. **To maintain the integrity and safety of your boat, only qualified people should perform maintenance on, or in any way modify, the steering system, propulsion system, engine control system, fuel system, environmental control system, or electrical system.** Failure to maintain these systems as designed could violate Federal law, and could expose you and other people to the danger of bodily injury or accidental death. We recommend that you follow the instructions provided in this handbook, in the engine owner's manual, and in the accessory instruction sheets included with your boat. We also recommend that you perform the following steps:

1. Make certain that you receive a full explanation of all systems from the dealer before taking delivery of your boat. Your selling dealer is your key to service. If you experience any problems with your new Bayliner, immediately contact the dealership. If for any reason your selling dealer is unable to help, call us direct on our customer service hotline for assistance. The number is (360) 435-8957.
2. Read this manual thoroughly, paying particular attention to the subjects of **fueling, checking for fumes, starting, carbon monoxide, loading limits, trim tabs, recommendations for safety, and warranty.**
3. Practice—all members of the family should be familiar with the operation and systems of your boat.
4. Participate in a safe boating course. Call the local office of the United States Power Squadrons or the United States Coast Guard Auxiliary for the date and location of their next class.

# Contents

<b>WELCOME ABOARD</b> .....	1	<b>COMPONENTS/SYSTEMS</b> .....	16
<b>PREPARATION</b> .....	5	Electrical System (12-Volt DC) .....	16
Recommendations for Safety .....	5	Electrical System (110-Volt AC) .....	17
Trim .....	6	Generator (optional) .....	18
Other Tips .....	6	Water Heater .....	18
Safety Equipment .....	7	Air Conditioning/Heating (optional) .....	18
Tool Chest .....	7	Anchor Winch (optional) .....	18
Miscellaneous Items .....	7	Battery Charger .....	18
<b>OPERATING</b> .....	8	110-Volt/12-Volt Refrigerator .....	19
Fueling Procedures .....	8	Starter Motor .....	19
Prestart Inspection .....	8	Bilge Blower .....	19
Starting Procedure (Diesel Engines) .....	9	AM/FM Cassette Stereo .....	19
Starting Procedure (Gas Engines) .....	9	Depth Sounder .....	19
Engine Idling Inspection .....	10	Navigation Lights .....	19
Engine Break-in .....	10	Fuel System .....	20
Carbon Monoxide (CO) .....	10	Marine Head with Holding Tank .....	20
Before You Leave .....	11	Potable Water System .....	20
Maneuvering .....	11	Bilge Pumps .....	21
Basic Maneuvering .....	11	Alcohol Stove .....	22
Stern Drive Trimming .....	12	Steering .....	22
Docking .....	12	Spotlight .....	22
Towing .....	13	Canvas Installation .....	23
Boat Performance .....	13	<b>GENERAL MAINTENANCE</b>	
Boat Running Trim .....	13	<b>AND REPAIRS</b> .....	24
Trim Tabs .....	13	Bilges/Engine Compartment .....	24
Instruments .....	14	Cabin and Topside Areas .....	24
Grounding .....	14	Hull .....	26
Structural Limitations .....	14	<b>STORAGE</b> .....	27
Engine Shut-Down .....	15	<b>NAUTICAL TERMS</b> .....	28
		<b>SYSTEMS DRAWINGS</b>	
		<b>AND DIAGRAMS</b> .....	29
		<b>WIRING DIAGRAMS</b> .....	35
		<b>LIMITED WARRANTY</b> .....	41

*(pages 2 1/2, 4 are blank)*

## PREPARATION

Prior to leaving on your first outing (or, for that matter, any outing) there are certain items to check and activities to perform. Beside reading this manual and your engine manual, familiarize yourself with your boat while dockside, and consider the following suggestions:

### Recommendations for Safety

#### 1. Personal Flotation Devices:

One Coast Guard approved personal flotation device (PFD) of suitable size is required for each person aboard a recreational boat. New PFDs bearing Coast Guard approval are now identified as Type I, II, III, or IV.

Requirements for boats sixteen feet (16') or over in length: One (1) Type I, II, or III (wearable) PFD for each person on board, and one (1) Type IV (throwable) PFD in each boat.

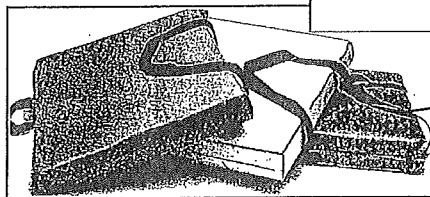
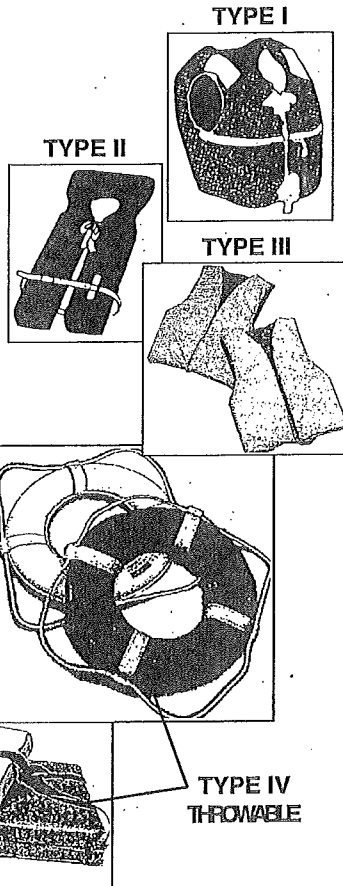

2. Always have children wear PFDs. Always check those devices intended for young children for fit and performance in the water. Never hesitate to have "all hands" wear life-saving devices whenever circumstances cause the slightest doubt about safety.



3. If a U.S. Coast Guard capacity placard is attached to your boat do not exceed the load specified and take care to properly load your boat. Maintain adequate freeboard at all times. Consider the sea conditions, the duration of the trip, the weather and the experience of the personnel on board.
4. The operator of the boat is responsible for the safety of his passengers as well as his own. You should insure that everyone aboard is properly and securely seated in appropriate seating locations before starting. You should not allow sitting on seatbacks, gunnels, bows, transoms, fishing seats, or sun lounges while underway. In many states it is illegal.

#### **⚠ DANGER**

Do not allow anyone to ride on parts of the boat that were not designed for such use. Sitting up on seat backs, bow riding, gunwale riding, transom platform riding, or lounging on forward deck while underway is especially hazardous and will cause personal injury or death.

#### **⚠ WARNING**

Do not allow anyone to occupy the transom platform while the engines are operating (this applies even when the shifters are in neutral).

5. Falls are the greatest cause of injury both afloat and ashore. Eliminate tripping hazards where possible, make conspicuous those that must remain, and require that everybody on board wear proper footwear.
6. Boat operators are required by law to file a Boating Accident Report with their state boating law enforcement agency when their boat is involved in certain boating accidents. A boating accident must be reported if (1) there is loss of life or probable loss of life, or (2) there is personal injury requiring medical treatment beyond first aid, or (3) there is property damage to boats or other property where the damage value exceeds \$500.00, or (4) there is complete loss of the boat. For further information and assistance contact the local law enforcement authorities.
7. Never drive the boat directly behind a water skier. At 25 m.p.h. the boat will overtake a fallen skier who was 200 feet in front in 5 seconds.
8. Understand the meanings of navigation buoys, and never moor to one. (It is a Federal offense.)
9. Know the various distress signals. A recognized distress signal used on small boats is to slowly and repeatedly raise and lower the arms outstretched to each side.
10. Storm signals are for your information and safety. Learn them and be guided accordingly.

11. A special flag (red flag with a white diagonal stripe or blue and white International Alpha) flown from a boat or buoy means diving operations are underway nearby. Approach with caution and stay clear by at least 25 yards.
12. Make sure your boat's engine is shut down before allowing people to swim to or from your boat, or to swim anywhere near your boat. Before lowering the transom boarding ladder, shut the motor OFF and remove the key from the ignition switch so that nobody will accidentally start the engine while swimmers are nearby. Also, slow down and exercise extreme caution any time you are cruising in an area where there might be swimmers or water skiers in the water. Never back up to anyone in the water.
13. Watch your wake. It might capsize a small craft. You are responsible for damage caused by your wake. Pass through anchorages at a minimum speed.
14. Learn and abide by common boating "rules of the road".
15. Always have up-to-date charts of your cruising area on board.
16. Keep an alert lookout. The operator is required by law to "maintain a proper lookout by sight (and hearing). He must insist that he has an unobstructed view particularly to the front. No passengers, load or fishing seats should block his view when operating the boat above idle speed.
17. Always instruct at least one person on board in the rudiments of boat handling in case you are disabled or fall overboard.
18. Consider what action you would take under various emergency conditions such as a person overboard, fog, fire, a damaged hull or other bad leaks, motor breakdown, severe storm or collision.
19. If your boat ever capsizes, remember that if it continues to float, it is usually best to remain with it. You are more easily located by a search plane or boat.
20. Keep firefighting and lifesaving equipment in good condition and readily available at all times.
21. Do not test fire extinguishers by squirting small amounts of the agent. The extinguisher might not work when needed. Always follow approved instructions when checking fire extinguishers.
22. Have an adequate anchor and sufficient line (at least six times the depth of the water) to assure a secure hold in all types of weather and sea conditions.
23. Boat hooks are valuable when docking or when needed to retrieve objects that have fallen overboard.
24. Keep electrical equipment and wiring in good condition. Knife switches or other arcing devices should **never** be installed in fuel compartments. Allow ample ventilation around batteries.
25. Good housekeeping in your boat is important. Cleanliness diminishes the probability of fire.
26. Know your fuel tank capacity and cruising range. If it is necessary to carry additional fuel, do so only in proper containers. Take special precautions to prevent the accumulation of fuel vapors in confined spaces.
27. Before departing on a boat trip, advise a responsible friend or relative about where you intend to cruise. Be sure to give that person a good description of your boat. Keep them advised of any changes in your cruise plans. These precautions will enable your friend or relative to tell the Coast Guard where to search for you and what type of boat to look for if you fail to return. Be sure to advise the same person when you complete your trip to prevent any false alarms about your safety.
28. Your local United States Coast Guard Auxiliary, the United States Power Squadrons, The Red Cross, and your state boating law enforcement agency offer safe boating classes several times a year. These are comprehensive courses, and are generally of minimal cost to you. Call your local U.S. Coast Guard Auxiliary, Power Squadron Flotilla, or your state agency for the time and place of their next class. Inquiries can be made to the Boating Safety Hotline, 1-800-368-5647 or to the Boat U.S. Foundation information number 1-800-336-BOAT.

Remember these are recommendations only. Check with the proper authorities for the exact safety requirements for your area.

### Trim

---

*Trim* refers to the way your boat floats in the water. When floating properly as designed, it is on an *Even Keel*. If it inclines to port or starboard, it *Lists*. If loaded too heavily forward, it *Trims By The Head* (or is *Down By The Bow*). If it's draft is excessive aft, it *Trims By The Stern* (is *Down By The Stern*).

Your boat's trim can be affected by many variables such as optional equipment and loading of gear or cargo. Load gear and cargo as evenly as possible. If necessary, move heavy items to the opposite side (or end) to achieve proper trim.

### Other Tips

---

1. When commissioning a new boat, do not plan an extensive trip until you have taken a shakedown cruise to make sure all equipment on your boat is functioning properly and you are familiar with its operation.
2. Use big fenders or fender boards to protect your boat's hull whenever mooring next to floats, piers or other boats.
3. Carry plenty of line properly sized to your boat. We suggest at least four 60' lengths of 5/8" nylon line.

## Safety Equipment

---

The following safety-related items should be considered as part of your standard equipment:

1. Fire extinguishers (correct number and type, located for easy access)
2. Personal flotation devices
3. Fenders, lines and boat hook
4. Flares (night and day type with unexpired dates)
5. Flashlight(s) with extra batteries
6. Charts of your intended cruising area
7. First aid kit
8. Anchor and adequate line



## Tool Chest

---

1. Assorted screwdrivers (Phillips and flat blade)
2. Pliers (regular, vice-grip, and water pump)
3. Wrenches (box, open-end, allen, and adjustable, include one wrench large enough to fit the prop nut)
4. Socket set (metric and U.S. standard)
5. Hacksaw with spare blades
6. Hammer
7. Battery jumper cables
8. Electrical tape
9. Assorted fasteners
10. Gear grease and penetrating oil
11. Feeler gauges

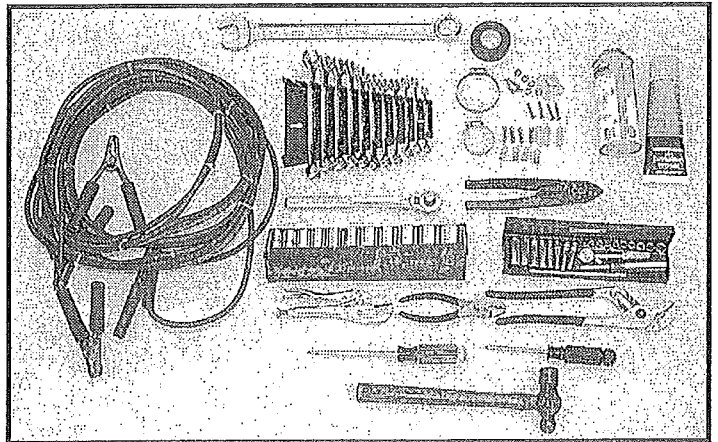

## Miscellaneous Items

---

1. Engine and accessories manuals
2. Spare propeller with fastening hardware
3. Propeller shaft packing material
4. Spare propeller shaft and strut
5. Extra V-belts
6. Engine lubricating oil
7. Transmission fluid
8. Spare fuel and oil filters
9. An extra cooling pump impeller
10. Replacement light bulbs



## OPERATING

### Fueling Procedures

#### **⚠ WARNING**

Fuel vapors are explosive and can become trapped in the lower portions of a boat where they might be ignited accidentally. While fueling your boat, all doors, hatches, and portlights must be closed.

#### **⚠ WARNING**

Do not use fuels that incorporate any form of alcohol or alcohol derivatives. Alcohol destroys marine fuel system hoses and components, which could lead to hazardous leaks, fire or explosion.

Fuel Capacity ..... 180 gallons

1. Be sure that your boat is securely moored to the dock.
2. Turn off all electrical equipment, including engines, generator, appliances, bilge blower, lights, etc.
3. Extinguish all cigarettes, cigars or other items that may produce a spark or flame.
4. Close all openings including hatches, windows, doors and portlights.
5. Through-deck fittings for fuel tank filling are found on both the port and starboard sides of the cockpit. Remove the cap and insert the fuel supply nozzle, allowing the nozzle to maintain contact with the fitting; this will prevent possible static sparking.
6. After about 10 gallons have been pumped into a tank, inspect the engine and tank area for signs of fuel leakage. Proceed with fueling if no problems are detected.
7. Often you won't be able to fill the fuel tanks to 100% of their dry-rated capacity. This is because the amount of fuel each tank will hold depends, in part, on the boat's floating attitude, which in turn affects the position of the fuel tank and its venting system. If fuel flows out the tank vent on the side of the boat, discontinue fueling that tank immediately. The tank will be as full as possible under the current conditions. It is advisable not to overfill the tanks as you want to allow for thermal expansion of the fuel, especially on very hot days.
8. If, when filling the tanks, you can't put fuel in at a reasonable rate, check the fuel vent line for that tank to see that it's not kinked or plugged.
9. When you have finished fueling, replace the fill cap and wipe off any fuel spillage.

10. Open the engine compartment and all windows, doors, and hatches; inspect, both visually and by smell, for fuel fumes or leakage. Any sign of fuel leakage, or any indication of fumes, must be investigated and corrected prior to starting the engine.
11. Operate the bilge blower for at least four minutes prior to starting the engines. Leave the blower on until the boat is underway and up to cruising speed.

### Prestart Inspection

An operation and maintenance manual for your engines is included with your boat. Prior to initial operation you should carefully read the contents of that manual.

Before starting the engines, check the following:

1. Fuel fumes.
2. Engine oil level.
3. Coolant level.

#### **⚠ WARNING**

To prevent severe burns or personal injury, DO NOT remove the heat exchanger caps while the engines or their cooling systems are hot.

4. Fuel level.
5. Transmission oil level.
6. Check that the fuel supply valves (and return valves on optional diesel engines) are open.

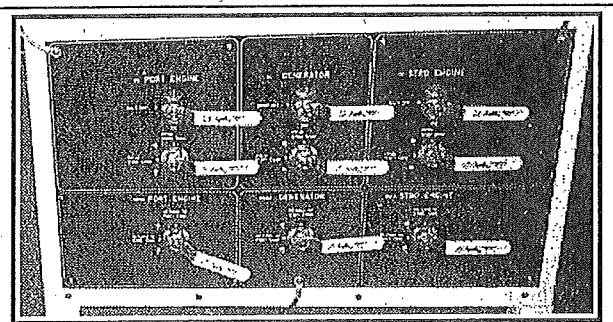

Fuel Management Board

NOTE: Fuel Management Boards will vary according to engine type.

7. Check that the seawater intake valves (seacocks) are open.
8. Visually inspect the water separators for moisture or contamination.
9. Visually inspect the seawater strainers for debris.
10. Check all V-belts for correct tension.
11. Visually inspect for indications of fuel, oil and coolant leaks.

## Starting Procedure (Diesel Engines)

The Engine Operating and Maintenance Manual furnished with your engine, describes prestart and starting procedures in detail. We **strongly** recommend that you thoroughly read and understand the engine operation manual prior to starting the engines. The following procedures are intended as basic reminders only.

1. Turn the battery switch ON.
2. Turn the engine room ventilation blowers ON. It is recommended that they are run for a minimum of four minutes prior to actual engine start.
3. Place the transmission selector lever in the NEUTRAL ("N") position.
4. Position the throttle control slightly above the idle position.
5. Turn the DC ignition breaker switches ON.
6. For a low temperature start (below 14°F/-10°C), use the preheater system. Hold the button in for 15 to 30 seconds (do not exceed 30 seconds).
7. If the engines have not been operated for a prolonged period of time, it may be necessary to lubricate the turbochargers. The turbochargers can be lubricated by performing the following steps:
  - Place the shifter in the neutral/stop position.
  - Place the throttle in the idle position.
  - Simultaneously depress the engine stop button and turn the ignition key to the start position. Operate the starter motor for fifteen seconds (the engine should not start during this procedure). Allow the starter motor to cool for fifteen seconds before starting the engines.
8. Turn the ignition key clockwise to start the port engine first. **DO NOT** continuously operate the starter for more than 15 seconds at a time.
9. If the engine does not start, wait at least 30 seconds before making another attempt. If after two attempts the engine does not start, try to determine the cause before proceeding.
10. A "low oil pressure" buzzer will activate when the key is turned on. If this warning does not cease within a few seconds after start-up, turn the engine off and investigate before a restart is attempted.
11. When the port engine starts, release the key. The key will automatically return to the running position. Start the starboard engine in the same manner.

### ▲ WARNING

**Do not use ether or starting fluid as a starting aid as this may result in a fire or explosion.**

12. Do not "race" the engines or allow either engine's RPM to exceed slow speed (750-1200 RPM) until they have warmed up.

## Starting Procedure (Gas Engines)

### ▲ WARNING

**Gasoline vapors are highly explosive. To prevent a possible explosion and/or fire, check the engine room before each start for fumes or accumulation of fuel. Before starting the engines, operate the engine room ventilation blowers for a minimum of five minutes. Leave the blowers on during the starting process and anytime you are operating below cruising speeds.**

The Engine Operating and Maintenance Manual furnished with your engine, describes prestart and starting procedures in detail. We **strongly** recommend that you thoroughly read and understand the engine operation manual prior to starting the engines. The following procedures are intended as basic reminders only.

1. Turn the battery switch ON.
2. Turn the engine room ventilation blowers ON. It is recommended that they are run for a minimum of four minutes prior to actual engine start.
3. Place the transmission selector lever in the NEUTRAL ("N") position.
4. Position the throttle control slightly above the idle position.
5. Turn the DC ignition breaker switches ON.
6. If the engine does not start, wait at least 30 seconds before making another attempt. If after two attempts the engine does not start, try to determine the cause before proceeding.
7. A "low oil pressure" buzzer will activate when the key is turned on. If this warning does not cease within a few seconds after start-up, turn the engine off and investigate before a restart is attempted.
8. When the port engine starts, release the key. The key will automatically return to the running position. Start the starboard engine in the same manner.
9. Do not "race" the engines or allow either engine's RPM to exceed slow speed (1500 RPM) until they have warmed up.



## Engine Idling Inspection

- As the engines are warming up:
  - Check that the oil pressure reading is at least 40 PSI. IMMEDIATELY stop the engine if low oil pressure is indicated and determine the cause prior to attempting a restart.
  - Observe the exhaust outlets to verify cooling water discharge.
- Allow the engines to warm up for 5-10 minutes. With the idle speed at approximately 1000 RPM, check the following:
  - Oil pressure 40 PSI or higher
  - Water temp. 135° - 190°F
  - Voltage meter 12-15.5 volts
  - Fuel gauge Sufficient fuel
  - Exhaust gas Should be colorless or light blue. Also, there should be water out flow with the exhaust; this indicates cooling water circulation.
- Prior to closing the engine hatch, check for liquid and exhaust leaks, and remove tools, gloves, rags, etc. from on and around the engine.
- Turn the steering wheel full port and starboard and check for proper operation.

### **⚠ WARNING**

Always pull the throttle lever back to SLOW before moving the shift lever to FORWARD or REVERSE. Failure to do so can cause transmission damage.

## Engine Break-in

All engines are test run prior to delivery. Nevertheless, it is extremely important to follow proper break-in procedures to insure many years of economical and trouble-free operation.

## 30 Hour Engine Break-in (Diesel)

- During the first five hours of operation, do not exceed an engine speed of 2500 RPM.
- From 5 to 30 hours of operation, do not run at full throttle speed for more than 5 minutes.
- During the first 30 hours, it is recommended that the engine is neither idled nor operated at a single RPM setting for extended periods of time.

## 20 hour Engine Break-in (Gas)

- During the first 10 hours of operation, do not operate below 1500 RPM for extended periods of time. Shift into gear and advance the throttle above 1500 RPM as soon as possible, *if conditions permit safe operation*.
- Do not operate at one speed continuously for extended periods.
- Do not exceed 3/4 throttle during the first ten hours. During the second ten hours, occasional operation at full throttle is permissible (five minutes at a time maximum).
- Avoid full throttle acceleration from IDLE speed.
- Do not operate at full throttle until the engine reaches normal operating temperature.
- Check the crankcase oil level frequently. Add oil if necessary. Oil consumption is normally high during the break-in period.
- After completing the 20 hour break-in period, change the crankcase oil and filter (see your Engine Operating and Maintenance Manual).

## Carbon Monoxide (CO)

### **⚠ DANGER**

Carbon monoxide (CO) is a poisonous gas that is colorless, odorless and about the same weight as air. It will distribute itself throughout spaces of the boat in dangerous concentrations if proper ventilation is not provided. A person breathing these fumes will become seriously ill. Direct and prolonged exposure will cause brain damage or death. Opening windows or hatches may improve ventilation. Also, never operate the engine when either the slant cover or the camper cover is installed.

Because CO diffuses in the air much more rapidly than easily detectable gases you cannot rely on sight or smell to recognize its presence. CO will be produced anytime materials containing carbon are burned. Common sources of CO are internal combustion engines and open flame devices such as cooking ranges, space heaters, and charcoal grills.

The symptoms of CO poisoning include but are not limited to the following:

- Watering and itchy eyes
- Flushed appearance
- Inattentiveness and the inability to think clearly
- ringing in the ears
- Tightness in the chest

6. Headache and/or throbbing temples
7. Drowsiness and fatigue
8. Incoherence
9. Nausea and/or vomiting
10. Dizziness
11. Collapse
12. Convulsions

If someone is suffering from CO poisoning move the person to fresh air, administer oxygen if available, and contact medical help. If the victim is not breathing perform approved CPR procedures until medical help arrives and takes over.

To help prevent exposure to CO, be aware of your ventilation and surroundings. Running your engine in a confined space such as a boathouse or next to a seawall can allow dangerous accumulations of CO. Another boat with an engine running moored nearby can also expose you to dangerous amounts of CO. Be sure that while underway there is a good flow of fresh air through the boat and that exhaust fumes are not being pulled up into the boat by "backdrafting". Backdrafting will be greater whenever canvas is installed or if you run in a bow-up trim angle.

### **▲ WARNING**

**Gasoline portable generator sets produce CO. These units discharge their exhaust where they are located which can lead to the accumulation of CO in the area. This equipment should *NEVER* be used on recreational vessels.**

## **Before You Leave**

Before you leave the dock, perform the following steps in addition to the instructions listed under "Starting Procedures":

1. Check fluid levels in the generator.
2. Check the operation of the more essential equipment such as bilge pumps, running lights, wipers, water system, radios, navigation aids, etc.
3. Instruct passengers in the use and location of flotation devices and fire extinguishers.
4. Fill the fresh water tanks.
5. Obtain a reliable weather forecast and plan accordingly for everyone's comfort and safety.
6. Notify a responsible friend or relative of your cruise plans. Upon your return or a change in your cruise schedule, notify that person again in order to avoid unnecessary concern.

## **Maneuvering**

When all of your predeparture checks have been completed, you will be ready to leave the dock.

### **Basic Maneuvering**

Steering your boat at either idling or cruising speeds will generally require minimal effort. Practicing maneuvers at slow speeds will help you to become familiar with all the special handling characteristics associated with your boat.

Remember that all boats steer by the stern (the feeling is much like steering your automobile in reverse). This means that the stern of your boat will swing in the direction opposite to your turn. For example, when you turn the helm wheel to port, the stern of the boat will swing to starboard as the boat goes into a port turn. This is especially important to keep in mind when docking and when operating in close quarters with other boats.

Your boat has twin propellers, so you can engage one engine in forward gear and the other in reverse gear to turn the boat completely around in its own length. Usually the rudders are left in the centered position. You can make such a turn in either direction. Port engine forward and starboard engine in reverse spins you clockwise. Starboard engine forward and port engine in reverse spins you counterclockwise. You usually can increase the rate of spin by turning the rudders in the direction of the spin.

Always use extreme caution when approaching someone in the water. Approach them from the leeward side at idle speed only, allowing your stern to swing away from them as you get close. Place the shifter in NEUTRAL and shut off the boat's motor when you are still several feet from the person in the water. While they are swimming over to the boat, lower the swim ladder from the transom platform so they can board. Once everyone is aboard, return the swim ladder to its stowed position and check that everyone is safely seated before restarting the motor. If you are unfamiliar with picking up swimmers in the water, practice this maneuver with a retrievable floating object before attempting it under actual conditions.

Boats do not have brakes. Stopping is accomplished by backing down on the throttle. Once the boat has slowed and the motor is idling, you can place the shifter in REVERSE. Gradually increasing reverse power with the throttle will allow you to stop the boat in a very short distance. Note that a boat will not respond to steering in reverse nearly as well as it does when going forward, so do not expect to accomplish tight turning maneuvers when backing up.

Once you are away from the dock, devote some time to learning how to maneuver.

- Practice docking by using an imaginary dock.
- Practice stopping and reversing.
- When operating in close quarters or docking, all maneuvering should be done at idle speed.

- Proceed with caution in congested areas.
- Gradually increase your speed. Get used to the boat before attempting any full throttle operation.

## Stern Drive Trimming

You can change the angle of your prop shaft by pressing the trim switch on the shifter/throttle lever. For an explanation of the handling characteristics caused by trimming your stern drive see your engine owner's manual.

### Bow steering:

Your boat is designed to give you quick acceleration with a minimum of time spent in the bow-up transitional planing off condition. Planing your boat is most easily and quickly accomplished by trimming the stern drive fully "under" or "in" and using moderate to maximum throttle. Once on plane, the stern drive should be trimmed out a little to avoid a bow down condition called "plowing". Plowing can cause "bow-steering" or "oversteering" and increase fuel consumption. In this condition, if attempting a turn or encountering diagonal waves, a more abrupt turn than intended may result.

## Docking

### Preparation:

Proper docking requires practice and preparation. Start by making sure you have adequate mooring gear, and that it is stowed correctly and is ready for use. Your dealer is the best source for information concerning the amount and type of equipment you should carry.

### Approaching the Dock:

When approaching a mooring area, lower your speed within a reasonable distance to allow your wake to subside before it reaches other boats or docks. As you get close to your moorage, check for any wind or current action that may affect your maneuver; then make a conservative

approach with these factors in mind. Try to use the elements to your advantage. Allow them to carry the boat to the dock. If there are high winds or strong currents, it is best to approach the moorage from the lee side. While approaching, check to see that all lines are attached to the cleats on the side facing the moorage. Also insure that fenders are lowered on that side. Be sure to check that the fenders are hung at the proper height.

As you approach your moorage, it is desirable to have one person at the bow and one at the stern of the boat, each with a boat hook and a mooring line attached to a cleat. Approach at idle RPM at an angle approximately 45 degrees to the dock. When the bow is within a few feet of the dock (starboard side), the stern can be brought alongside the moorage by reversing the port engine and leaving the rudders amidships. These steps are reversed for docking to port.

## WARNING

Whenever docking all crewmembers and passengers should remain in the boat until maneuvering is complete. Do not attempt to dock with anyone standing on the transom platform. Also, NEVER allow anyone to use their body (including hands and feet) in an attempt to fend the boat away from objects being approached.

### Mooring:

To attach lines to deck cleats, make a loop in one end of the line and pass it through the hole in the base of cleat; then pass the loop back over the entire cleat. The line can now be used to secure your boat. Lines may be kept this way while underway as long as they are coiled and cannot become fouled in deck gear or props. In heavy sea conditions, all lines should be removed from the decks.

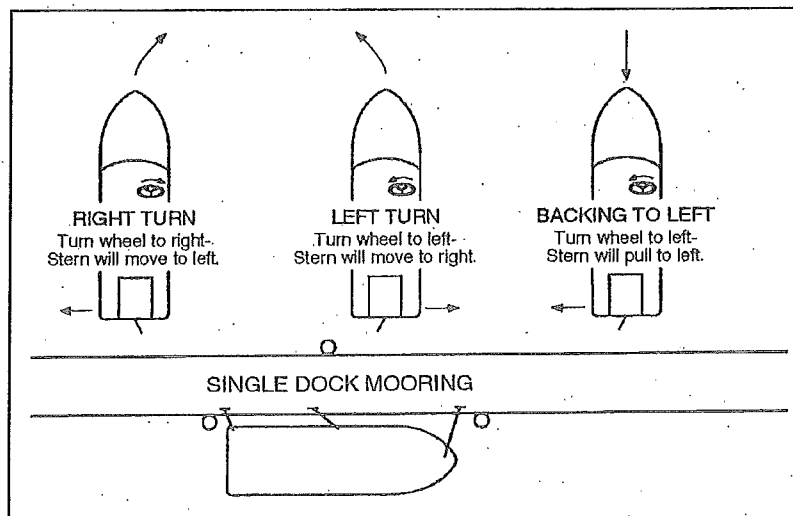

### Leaving the Dock:

Take into account wind, tide, current and other forces that affect your maneuvering. Most maneuvering to and from a dock is best accomplished at idle speeds. Do not forget to release mooring lines, unhook shore power cords, and stow fenders.

### Towing

If it becomes necessary to have your boat towed, attach the tow line to the bow eye (if so equipped). If your boat is not equipped with a bow eye, the Coast Guard or other professional assistance should be sought to properly rig a tow bridle. Deck hardware should never be used for towing.

#### **⚠ WARNING**

**Never attach a towline to deck cleats or to the anchor windlass. Serious injury may result if the cleats or windlass pull free from the deck.**

More thorough information is available through the U.S. Coast Guard Auxiliary or U.S. Power Squadrons.

### Boat Performance

Boat speeds are affected by a great many factors. Some, such as temperature and altitude, you cannot change, but some factors you can:

1. **Loading:** Take only necessary equipment with you. Keep weight low in the boat and balanced.
2. **Propellers:** Keep them in good repair and at the correct pitch for your particular situation. The factory standard propellers may not be the best for your particular boat and load conditions. The diesel engine should be able to come up to 3000 RPM (gas engine, 4000 - 4400 RPM) on a normally loaded boat. If your engine RPM at full throttle does not meet these ratings ask your Bayliner Dealer about trying different propellers.  
A slightly bent or nicked propeller will adversely affect the performance of your boat.
3. **Keep your boat's bottom clean** of weeds, barnacles and other growth. When your boat's hull starts "growing grass", it will slow down greatly.

### Boat Running Trim

1. If your boat runs with its bow too high at cruising speeds, move weight forward in the boat or adjust the trim tabs (see trim tab section below).
2. If your boat runs with its bow too low at cruising speeds (usually indicated by steering difficulty), you can raise the bow by moving weight aft or adjusting the trim tabs (see trim tabs next section).

### Trim Tabs

Trim tabs control the longitudinal and lateral trim of your boat at cruising speeds. Two rocker switches, identified by the words BOW DOWN, are located at each helm station.

Typical Trim Rocker Switches

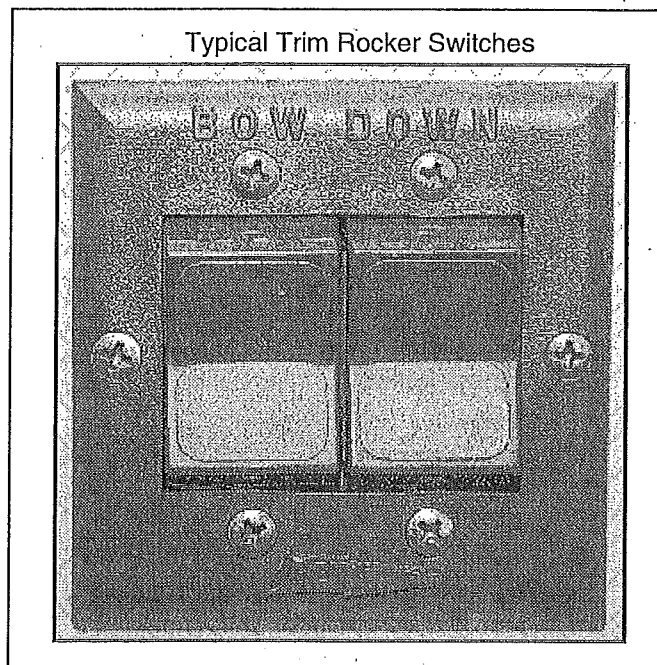

Once the best bow cruising trim is achieved, activate the port or starboard trim switches individually to correct for unequal lateral loading. Do not use trim tabs to compensate for excessive unequal weight distribution.

Trim tab adjustment should be performed by several short touches of the trim button, rather than one long one. Allow approximately five seconds for the hull to react between each switch activation.

The trim tab hydraulic fluid reservoir is located on the port side of the transom. The fluid level should be checked periodically (at least once per year) and re-filled as necessary.

#### **⚠ WARNING**

**Improper use of trim tabs will cause a loss of control. Do not use trim tabs in a following sea, as they may cause broaching or other unsafe handling characteristics. Do not allow people who are unfamiliar with trim tabs to operate them.**

## Instruments

---

While under way, instruments should be checked frequently for possible indications of trouble. All the instruments listed below are located at both helm stations.

1. *Tachometer*—Indicates engine revolutions per minute (RPM). The tachometer is useful for monitoring engine speed to avoid exceeding the maximum RPM rating.
2. *Temperature Gauge*—Indicates engine coolant temperature by monitoring a signal from a sending unit installed in the engine water jacket. When the gauge reads in the danger area, shut off the engine and diagnose the problem. A common cause of overheating is picking up a foreign object in the seawater intake. Clearing the intake or seawater strainer will usually rectify this problem.
3. *Oil Pressure Gauge*—Indicates engine lubricating oil pressure. Low pressure readings are generally caused by low oil quantity. In any case, immediately shut down the engine and diagnose the problem.
4. *Fuel Gauge*—Indicates the approximate fuel level. Since boats are exposed to rough water conditions and varying degrees of trim, it will not always be possible to fill the tank to 100% of its dry-rated capacity. Therefore, fuel gauges may seem to provide inaccurate readings at times. It is always good to keep track of the amount of fuel you pump aboard, as well as your running time and estimated fuel usage as a double check against an inaccurate gauge.
5. *Compass*—Before using your compass for marine navigation, you must have it professionally swung. Many factors affect the operation of your compass, such as local magnetic variation and deviation (induced needle deflection caused by metal components, the operation of electrical equipment aboard your boat, and items containing ferrous metals i.e. binoculars that may be set near the compass). Your Bayliner dealer can refer you to local shops that perform this work.

## Grounding

---

Running aground is often merely inconvenient but in extreme situations it may also be dangerous. As in any emergency situation the most important thing to do is remain calm, don't panic. If you find yourself aground, resist the temptation to immediately gun the engine in reverse in an attempt to back off. If the boat has grounded in mud or sand this may cause the prop to blow more mud or sand under the boat grounding it more firmly. In addition, mud or sand may get into the engine water intake and possibly the engine itself. Following are brief explanations

of possible actions to take in the event of grounding. More thorough information is available through the U.S. Coast Guard Auxiliary or U.S. Power Squadrons.

1. Shift to NEUTRAL and set the throttle to idle.
2. **Immediately** switch on the bilge pumps. Inspect the hull to see whether it is punctured and taking on water. Hand operated bilge pumps are good safety items to have aboard in case the electric pumps cannot remove the water fast enough. The engine's cooling pump can also be used by shutting down the engine, closing the seacock, disconnecting the water hose and fitting the end with a filter screen. Put the end of the hose into the water in the bilge and restart the engine. **Check frequently that the engine cooling system has a continuous supply of water.** Canvas, cushions, or even bedding can be used as temporary patches to the outside of a stove in hull. Hold the patches in place with docking lines. If taking on water rapidly, it may be better to leave the boat grounded. She may sink if moved to deeper water. Make a "PAN-PAN" (pronounced Pawn-pawn) distress call on channel 16 on the VHF radio. A "MAYDAY" distress signal should only be used if you or your boat are in grave and immediate danger.
3. If in tidal waters check the status of the tide. If coming in, it may lift the boat enough to get you free. Wakes from passing boats will also help lift you off. If the tide is falling take as many soundings as possible to determine the direction of deepest water. Then fasten the anchor line to the stern cleats, put the anchor and line in the dinghy and row the anchor out to deeper water paying out line from the dinghy. Pay attention to wind and current. Set the anchor upwind or upcurrent from the boat (this is called *kedging*). Pull the anchor line and use moderate reverse engine power if necessary. A "block and tackle" or "come-along" will greatly increase your pulling power and are good items to have aboard. If you need assistance make a "PAN-PAN" distress call as stated above.

## Structural Limitations

---

Transom and bow platforms are designed to be lightweight for proper boat balance. The load limit for these platforms is 30 pounds per square foot evenly distributed.

## Engine Shut-Down

---

1. Cool the engines down gradually, allowing them to idle in neutral for at least five minutes.

### NOTICE

**Gradual cool-down of turbocharged engines is absolutely necessary to avoid shortened turbocharger life.**

### CAUTION

**Follow steps 2, 3, 4, and 5 in sequence to avoid the possibility of electrical system damage.**

2. To turn the engines off, push the STOP buttons.
3. After the engines stop rotating, turn the ignition keys counterclockwise to the OFF position.
4. Turn the DC ignition breaker switches to the OFF position.
5. Turn the battery switch OFF.

### NOTICE

**Steps 6, 7, and 8 need not be followed for short term shut-down (overnight). For longer term storage refer to the storage section of this manual.**

6. Close the seawater intake valves (seacocks).
7. Close the fuel supply and return valves.
8. Carefully inspect the engine and engine compartment for indications of oil, fuel, water, or exhaust leakage.



## COMPONENTS/SYSTEMS

The following are highlights of some of your boat's onboard systems and components. Additional details are included in literature supplied with your boat.

### **⚠ DANGER**

**Knife switches or other arcing devices should NEVER be installed in fuel compartments.**

### **⚠ DANGER**

**NEVER substitute automotive parts for marine parts. Electrical, ignition and fuel system parts on your boat are designed and manufactured to comply with U.S. Coast Guard Rules and Regulations to minimize risks of fire and explosion.**

### **⚠ WARNING**

**Only qualified personnel should install batteries and perform electrical system maintenance. You can minimize the danger of fire and explosion by not exposing the batteries to open flame or sparks. It is also important that no one smoke anywhere near the batteries. Because fuel fumes are heavier than air, they will collect in the bilge areas where they can be accidentally ignited. Running the bilge blowers for at least four minutes prior to engine starting, electrical system maintenance, or activation of electrical devices will decrease the danger of fire and explosion. Also, insure that all battery switches are in the OFF position before performing any work in the engine spaces.**

### **NOTICE**

**Electrical connections are susceptible to corrosion. To help prevent electrical malfunction due to corrosion, keep all exposed electrical connections clean and protect them with a good quality spray-on protectant, such as *Corrosion Guard*®.**

## Electrical System (12-Volt DC)

Although Bayliner manufactures many different models of power boats, the electrical systems on all models operate on the same basic theory.

### 1. *Battery:*

The key to a good marine electrical system is the battery (the batteries are dealer-installed items). Bayliner recommends a minimum battery rating of **500 cold cranking amps**.

Your Bayliner is equipped with two master battery switches, one for the port engine circuit and the other for the starboard engine circuit. Both switches offer a crossover feature. The port circuit provides power for: port engine start, tilt/trim switch power, stereo/electronics, navigation lights, bilge blower, bilge pumps, horn, wiper, and trim tab pump. The condition of this battery can be read on the port voltmeter when the port ignition switch is in the ON position. The starboard circuit provides power for starboard engine start and all remaining 12-volt DC accessories. The condition of this battery can be read on the starboard voltmeter when the starboard ignition switch is in the ON position.

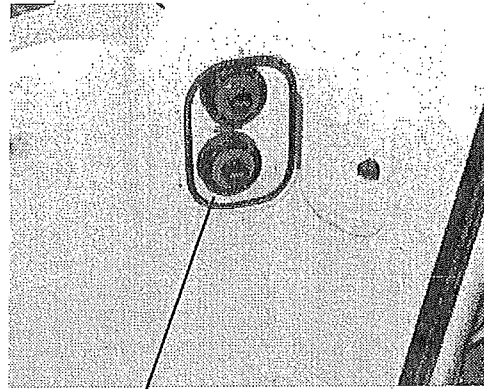

MASTER BATTERY SWITCHES LOCATED NEXT TO COCKPIT ENTRY DOOR

### **⚠ CAUTION**

**The crossover switch(es) should be turned on only in emergencies. Leaving the switch(es) ON can drain all onboard batteries. Also, you should never disconnect battery cables or turn the main battery switch(es) to the OFF position while the engine is running, as this can cause damage to your boat's electrical components.**

### **⚠ CAUTION**

**The battery charging systems (alternator and battery charger) installed are designed to charge conventional lead-acid batteries. Before installing gel-cell or other new technology batteries, consult with the battery manufacturer about charging system requirements.**

**Check the battery electrolyte level regularly.** Remove the caps on top of the battery and observe the level of the fluid inside. If the zinc plates are exposed, add distilled water until they are covered again. Corroded terminals can impair battery performance and charging ability. Clean them with baking soda and water; then coat them with a preservative or a light film

of grease. Be sure all battery connections are tight. When storing the boat, it is best to remove the battery, give it a full charge, and store it inside away from extreme temperatures.

2. *Fuses and Circuit Breakers:*

Standard equipment fuse blocks are located near the instrument panel. On diesel engine models, the engine circuit is protected by a circuit breaker on the engine and the accessory circuit is protected by an inline fuse at the battery switch. On gas engine models, engine and accessory circuits are protected by a large circuit breaker located on the engines. For more detailed information, refer to the wiring diagrams at the back of this manual.

**ACCESSORY FUSE BLOCK LOCATED UNDER UPPER STATION DASH JUST FORWARD OF SHIFTERS**

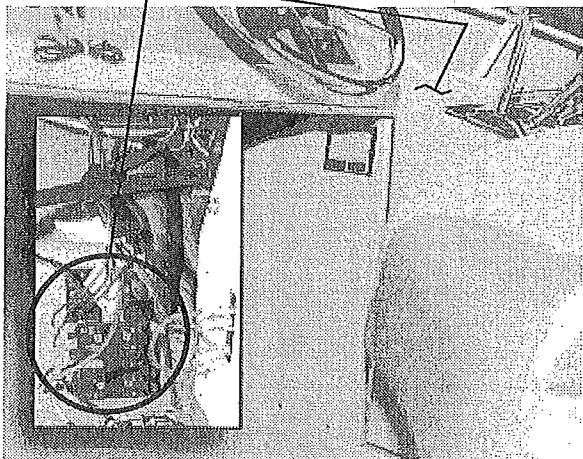

### Electrical System (110-Volt AC)

The AC system is energized by either shore power or the onboard generator (optional on some models).

Shore power receptacles are rated at 30-amps and appropriate power cords are furnished. Since not every shore installation has 30-amp service, we recommend that 15 and 20-amp adapters be purchased. However, whenever 15 or 20-amp adapters are used, there will be a corresponding drop in supplied power from the dockside system.

### ⚠ CAUTION

**Never hook dockside power to your boat overseas unless you purchased the overseas option, which is rated for 220 volt/50 Hz., whereas standard domestic systems are rated for 110 volt/60 Hz. power.**

### ⚠ WARNING

**Monitor the electrical control panel's polarity indicators when connecting shore power to your boat. A green light illuminating after the power cord is plugged into the boat's external power receptacle indicates acceptable electrical power. Therefore, you may energize the main breaker switches. However, a red light indicates reversed polarity, which could cause electrical system damage and possible electrical shock injuries. In this case, DO NOT energize the main breaker switches. Instead, immediately disconnect the shore power cord (always from the dockside outlet first) and notify marina management.**

**ANCHOR WINDLASS SWITCH (optional)**

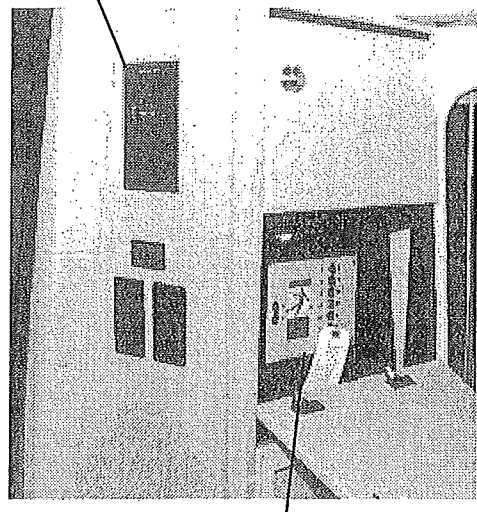

**A/C MASTER PANEL**

Before connecting to shore power ensure all breakers and switches on the A/C master panel are in the OFF position. Always attach the shore power cord to the boat inlet first, then to the dock connection, thereby avoiding accidental dropping of the "hot" cord into the water. Correspondingly, remove the dock connection first before removing the cord from the boat inlet.

On models with a single dockside inlet and not equipped with an auxiliary generator, check for proper polarity as outlined above. Activate the AC system by first turning on the master breaker, then each individual component breaker as required.

On models with dual dockside inlets and not equipped with an auxiliary generator, check for proper polarity as outlined above. Each dockside inlet is labeled inside the weatherproof cover, Line 1 or Line 2, which corresponds to the line each operates on the AC master panel. This system is designed so that each line operates indepen-

dent of the other. Activate the AC system by first turning on the master breakers, then each individual component breaker as required.

On models equipped with an auxiliary generator, the polarity light will work only when connected to the shore power. Activate the AC system by first turning the Ship/Shore selector switch to the desired position. Then switch on the master breaker and each individual component breaker as required. This system is designed so both ship and shore power sources **cannot** supply power simultaneously.

On models with dual dockside inlets and equipped with an auxiliary generator, the polarity lights will work only when connected to the shore power. Activate the A/C system by first turning the Ship/Shore selector switch to the desired position. When switched to the "Shore" position, Line 1 inlet corresponds with Line 1 on the master panel and Line 2 corresponds with Line 2 on the master panel. Again, each line operates independent of the other. When switched to the Generator position, **both** Lines 1 and 2 will operate. Then switch on the master breakers and individual component breakers as required. This system is also designed so that both ship and shore power sources **cannot** supply power simultaneously.

Whether using shore power or the generator, the simultaneous operation of several 110-volt accessories can result in an overloaded circuit. It might be necessary to turn off one accessory while operating another.

All models with 110-volt receptacles in the head and galley are equipped with ground fault circuit interrupters to protect users from electric shock. This device will also protect other **labeled** outlets.

### Generator (optional)

The literature package supplied with your boat has a very complete operator's manual for your generator. We urge you to read that manual prior to operating your generator, and to observe the following:

#### **⚠ WARNING**

**Fuel vapors can explode, before starting generator (or propulsion engines):**

- **Check generator compartment (or engine compartment) for gasoline or vapors.**
- **Operate blower for four minutes before starting generator ( or propulsion engines).**
- **Operate blower while boat is below cruising speed.**

1. Follow instructions in the generator operator's manual for prestart checks and break-in procedures.
2. Never operate the starter for more than 30 seconds. If the generator does not start, wait at least 30 seconds before making another starting attempt.

3. In addition to servicing the filters attached to the generator, any separate filter/separators should be serviced as indicated by the instructions included in your literature package.
4. The coolant mixture installed at the factory consists of equal parts of water and antifreeze.
5. The seawater intake valve must always be open during generator operation, and the seawater strainer should be checked frequently for debris.

### Water Heater

The water heater is connected to the 110-volt power system. If your boat is equipped with optional freshwater engine cooling, the coolant from the closed engine cooling system may be circulated through the hot water tank for heating of potable water. Heaters must be kept full of water to avoid damage to the 110-volt heating elements. They should also be drained (power turned OFF) when the possibility of freezing exists.

### Air Conditioning/Heating (optional)

Both heating and cooling (on boats equipped with air conditioning) are controlled from the same panel. Refer to the Environmental Control Unit booklet supplied in your information packet for detailed instructions concerning proper operation of the heating and air conditioning systems.

### Anchor Winch (optional)

The literature package includes instructions for the anchor winch. To haul the anchor, move the boat towards the anchorage using engine power until directly above it. Then activate the winch to disengage the anchor from the bottom by pulling it straight up. Do not pull the boat to the anchor using the winch or continue to operate the winch if it has stalled or overloaded.

### Battery Charger

#### **⚠ WARNING**

**The battery charging systems (alternator and battery charger) installed are designed to charge conventional lead-acid batteries. Before installing gel-cell or other new technology batteries, consult with the battery manufacturer about charging system requirements.**

The battery charger operates when 110-volt AC dockside power is connected and the battery charger circuit breaker is ON. On those models equipped with a generator, the battery charger also operates when the AC source selector switch is on GENERATOR, the generator is

running, and the battery charger circuit breaker is ON. The battery charger will charge the batteries regardless of the battery switch position.

### 110-Volt/12-Volt Refrigerator

The refrigerator operates on 110-volt AC and 12-volt DC power. When the 110-volt system is not hooked to an AC source, the refrigerator operates on 12 volts. When an AC source is supplied by dockside power and the 110-volt refrigerator breaker is ON, the refrigerator automatically switches to 110 volts.

The refrigerator is the heaviest continuous draw on the 12-volt system. If no other 12-volt accessories are used, the refrigerator can draw a 100-amp battery dead in less than 24 hours. For this reason it is recommended that when operating on 12 volts, the cold setting on the refrigerator should not be set higher than position two. It is also advisable to turn the refrigerator off at night. If you are going to be out more than one day and cannot connect to dockside power, you should plan to run the engine each day to maintain a charged battery.

### Starter Motor

The engine starter motor is designed to deliver high horsepower for only very short periods of time. Avoid operation for more than 15 seconds at a time. Allow at least one minute for cooling between start attempts. Due to its high horsepower, this motor builds up considerable heat and can be permanently damaged with prolonged use. If it does not operate, check the battery charge and all direct wiring for shorts or loose connections. The starter can be damaged in stern drive models if excess bilge water is allowed to come in contact with it. Automatic bilge pumps are recommended for boats left in open moorage.

### Bilge Blower

The bilge blower removes fumes from the engine compartment and draws fresh air into the compartment through the deck vents.

To ensure fresh air circulation, the bilge blower is to be used before starting the engine, during starting, and while the boat is operating below cruising speed. Operate the blower for at least four minutes before starting the engine.

#### ⚠ WARNING

Operation of the blower is NOT A GUARANTEE that explosive fumes have been removed. If you smell any fuel, shut off the engine and all electrical accessories and investigate immediately.

### AM/FM Cassette Stereo

The AM/FM cassette stereo that comes standard with your Bayliner has a separate brochure that explains its operating features. Note that AM radio reception will be impaired anytime the engine is running.

### Depth Sounder

Your Bayliner may come equipped with an electronic depth sounder. It will provide you with measurements of water depth beneath the boat. In many cases it also will help you locate schools of fish. The depth sounder comes with its own owner's manual. We suggest that you read it carefully before turning on the unit.

#### ⚠ WARNING

The depth sounder should not be used as a navigation aid to prevent collision, grounding, boat damage or personal injury. When the boat is moving, submerged objects will not be seen until they are already under the boat, or bottom depths may change too quickly to allow time for the boat operator to react. Always operate the boat at very slow speeds if you suspect shallow water or submerged objects.

### Navigation Lights

Vessels are required to have navigation lights turned on from "dusk to dawn" or in conditions of reduced visibility. It is wise to run at reduced speed whenever navigation lights are needed. Although the navigation lights supplied with your Bayliner are of top quality, failure may occur for a variety of reasons:

1. There may be a blown fuse. (Replace the fuse in the switch panel.)
2. The bulb may be burned out. (Carry spare bulbs for replacement.)
3. The bulb base may be corroded. (Clean the base periodically and coat it with nonconductive grease.)
4. A wire may have come loose or may be damaged. (Repair as required.)

#### ⚠ CAUTION

Avoid the storage of gear where it would block the navigation lights from view.

#### NOTICE

Prolonged operation of cabin interior lights (overnight) will result in a dead battery. Be conservative in the use of battery power.

## Fuel System

### ▲ CAUTION

**It is very important that the fuel system be inspected thoroughly the first time it is filled and then at each subsequent filling. For your safety and the safety of your passengers, the fueling instructions in this manual must be followed.**

#### *Fuel Fills and Vents:*

Fuel fills are located either on the aft deck or on the side decks adjacent to the aft cockpit. Fuel receptacle caps are marked "Fuel" or "Gas". Fuel vents are normally located in the hull or transom below and in the same general area as the fill. If you experience difficulty filling the fuel tank, check to see that the fuel fill and vent lines are free of obstructions and kinks.

#### *Antisiphon Valves:*

As required by the U.S. Coast Guard, the fuel systems on gasoline powered boats, except outboards, are equipped with antisiphon protection. Your boat may be equipped with an antisiphon valve, which is an integral part of the barb fitting on the fuel tank to which the neoprene fuel line attaches. The valve is spring loaded and is opened by fuel pump pressure. These valves will prevent gasoline from siphoning from the fuel tank in the event of a fuel line rupture.

### NOTICE

**If an engine running problem is diagnosed as fuel starvation, the antisiphon valve should be checked. In the event the valve is stuck or clogged, it should be cleaned or replaced while the engine is shut down. Under no circumstances should it be removed except in an emergency.**

#### *Fuel Filters:*

All fuel tanks are equipped with a fine mesh screen filter on the fuel pickup tube in the tank or on the tank to fuel line fitting. In addition, when supplied by the engine manufacturer, an additional filter is installed on the engine. Fuel filters should be checked periodically to see that they are clean and free of debris.

### ▲ CAUTION

**Avoid the storage or handling of gear near the fuel lines, fittings and tank.**

Make sure that your fuel suppliers are reputable and can be relied upon to furnish clean, proper, high quality fuel. Also, once you have found good suppliers, keep your tank as full as possible with their fuel. Then,

if you are forced to add to the tank with a potentially poor quality supply, the portion of poor quality fuel will be minimized.

Diesel fuel of ASTM grade 2-D is recommended. The minimum cetane value is 40 (45 for cold temperature operation), and the maximum sulfur content is 0.5%. If the sulfur content exceeds 0.5%, oil changes should be performed twice as frequently as indicated in the engine manual.

Air in the fuel supply system can stop an engine or severely restrict performance. Should air be introduced into your fuel lines, refer to your engine manual for detailed instructions on how to "bleed" it out of the system.

Consult your dealer or local marina concerning fuel additives that help to prevent fungus or other growth in your fuel tanks.

## Marine Head with Holding Tank

The marine head and holding tank system is designed so that sea water is used to flush waste from the toilet into the holding tank. The holding tank is plumbed to a waste fitting on the deck for use at a dockside pump-out station, and to a macerator pump so that waste may be pumped overboard where regulations permit. The push-button switch for the macerator is usually located at the helm station.

To operate the marine head, open the seacock on the seawater intake. Before using the head, pump some water in to wet the bowl. After use, pump until the bowl is thoroughly cleaned. Pump a few more times to clean the lines. If excess waste should cause the water to rise in the bowl, stop pumping until the water recedes.

If at any time you are unable to pump water into the bowl, the probable cause is debris in the pump diaphragm. To remedy this, shut the inlet seacock and dismantle the pump. The pump is generally held together with six screws. The design is simple and the problem will be obvious when the pump body is split open.

To winterize the toilet, shut off the intake valve and pump until the bowl is dry. Remove the drain plug in the base and pump again to remove all water. Do not fill the bowl with antifreeze. The inlet seacock should be left closed while the boat is underway, or whenever the boat is left moored in the water.

**Holding Tank Capacity .....52 Gallons**

## Potable Water System

Pressure type (demand) systems operate any time the electrical switch for the pump is in the ON position. Make sure the switch is OFF when the boat is not in use, or whenever the water tank is empty. (Switches are located in the galley.)

**Water Tank Capacity .....52 Gallons**

## Bilge Pumps

Your boat is equipped with three automatic bilge pumps, one located in the aft state room under the aft shelf, one in the engine room aft of the engines and the other beneath the removable floor at the bottom of the forward stateroom stairs. The electric bilge pumps supplied with Bayliners are impeller-type pumps. They are controlled by a switch on the dash panel, which should be activated whenever water begins to accumulate in the bilge. An automatic bilge pump switch ("autofloat switch") is mounted next to each pump. This is a float-type switch that will activate the bilge pump automatically whenever bilge water accumulates above a pre-set level. It is wired directly to the battery so it will normally function even when the boat is completely shut down and unattended, such as when the boat is moored at a marina.

Operation of bilge pumps should be checked frequently. To check bilge pumps, activate the dash-mounted switch and verify that any water in the bilge is pumped overboard. If bilge water is present and the pump motor is running but not pumping, check to see if the pump is clogged with debris. Lift the tab, rotate the fins counter clockwise and lift out the power cartridge (Fig. 1). Clear the housing of debris. To reinstall the power cartridge, first make sure the "O" ring is properly located (Fig. 2). Coat the "O" ring with a light film of vegetable oil or mineral oil. Align the two cams on either side of the power cartridge with the two slots in the outer housing. Press the power cartridge into the housing and twist clockwise. Ensure proper reinstallation by attempting to twist the fins counter clockwise without lifting the tab. The cartridge should stay in place.

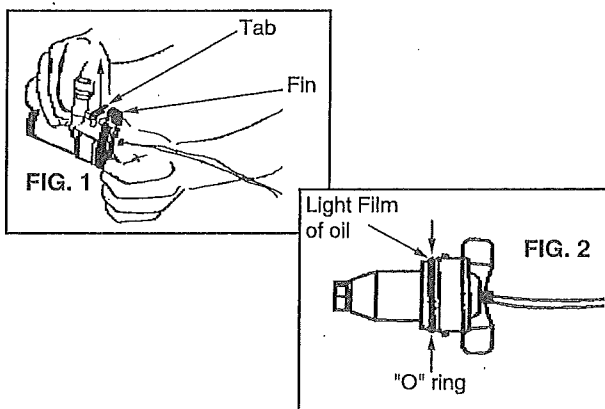

If the pump is clear but still does not move water, check the discharge hose for kinks or a collapsed area.

The autofloat switch should also be checked frequently for proper operation. The plastic insert, where the wires enter the housing, should rotate 1/4 turn counter clockwise (lifting the float).

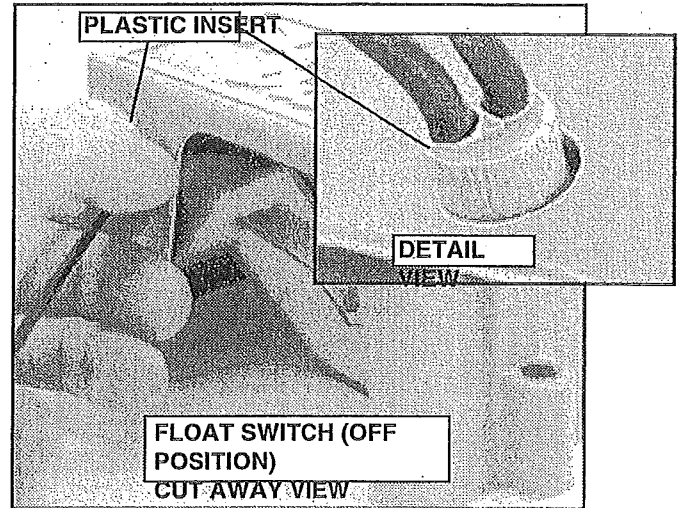

As you raise the float to its full upward position, the bilge pump should turn on.

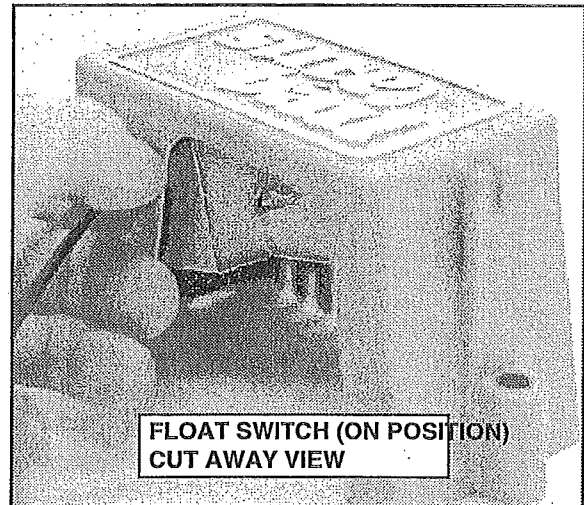

If raising the float does not switch the pump on, check the inline fuse at the battery switch board. Make sure it has not blown. If the fuse is good, but the switch still does not work, it usually indicates a bad switch, or possibly a low battery. In either case, call your dealership for further assistance.

### NOTICE

The Federal Water Pollution Control Act prohibits the discharge of oil or oil waste into or upon the navigable waters and contiguous zone of the United States if such discharge causes a film or sheen upon, or discoloration of, the surface of the water, or causes a sludge or emulsion beneath the surface of the water. Violators are subject to a penalty of \$5000.



## Alcohol Stove

---

Carefully read and follow the manufacturer's operating instructions supplied with your stove, and observe the following:

- Use only denatured alcohol labeled specifically for marine use.
- Do not operate the stove while underway.
- Do not fill the stove near an open flame or hot object.
- All spilled alcohol should be wiped up prior to lighting the stove.
- Don't put any cooking utensils on the stove until the burners are lit and functioning properly.
- **Never** attempt to use both alcohol and electric burners (if so equipped) simultaneously. To do so will cause overheating which can destroy the electric burner elements.

### WARNING

**Secure all combustible materials away from the stove before using the stove.**

## Steering

---

Your steering system is manual hydraulic, not power steering. At no time should you expect this system to turn as easily as a car's power steering.

You may notice a rhythmic pulsing when turning the wheel; this is a characteristic of the pump and is not a malfunction. Also, when coming off a hardover position, a resistance may be felt, followed by a distinct sound. This is a normal situation resulting from the release of the check valve.

The fluid reservoir for the hydraulic steering system is located in the aft end of the engine compartment. Following instructions in your literature package and on the reservoir, check the fluid level and pressure regularly.

## Spotlight

---

The spotlight can be controlled from the bridge helm station. The spotlight is located on the bow platform.

## Canvas Installation

Canvas installation is a two person job.

1. Attach end eyes of main bow (#1) to deck hinge plate/cap assembly (#2). Secure with pin.
2. Unfold bimini top and insert aft brace (#3) end eye into angled deck hinge located on radar wing (#4).

3. Pull forward on top making sure the canvas lies evenly from side to side. Insert end eye of forward brace (#5) into deck hinges mounted on forward console (#6). The canvas is in proper adjustment when it is smooth and taut.
4. The secondary bow (#7) jawslides are preset and should not need adjustment. Before attempting to adjust the secondary bow jawslide positions, obtain the correct measurements from your Bayliner Dealer.

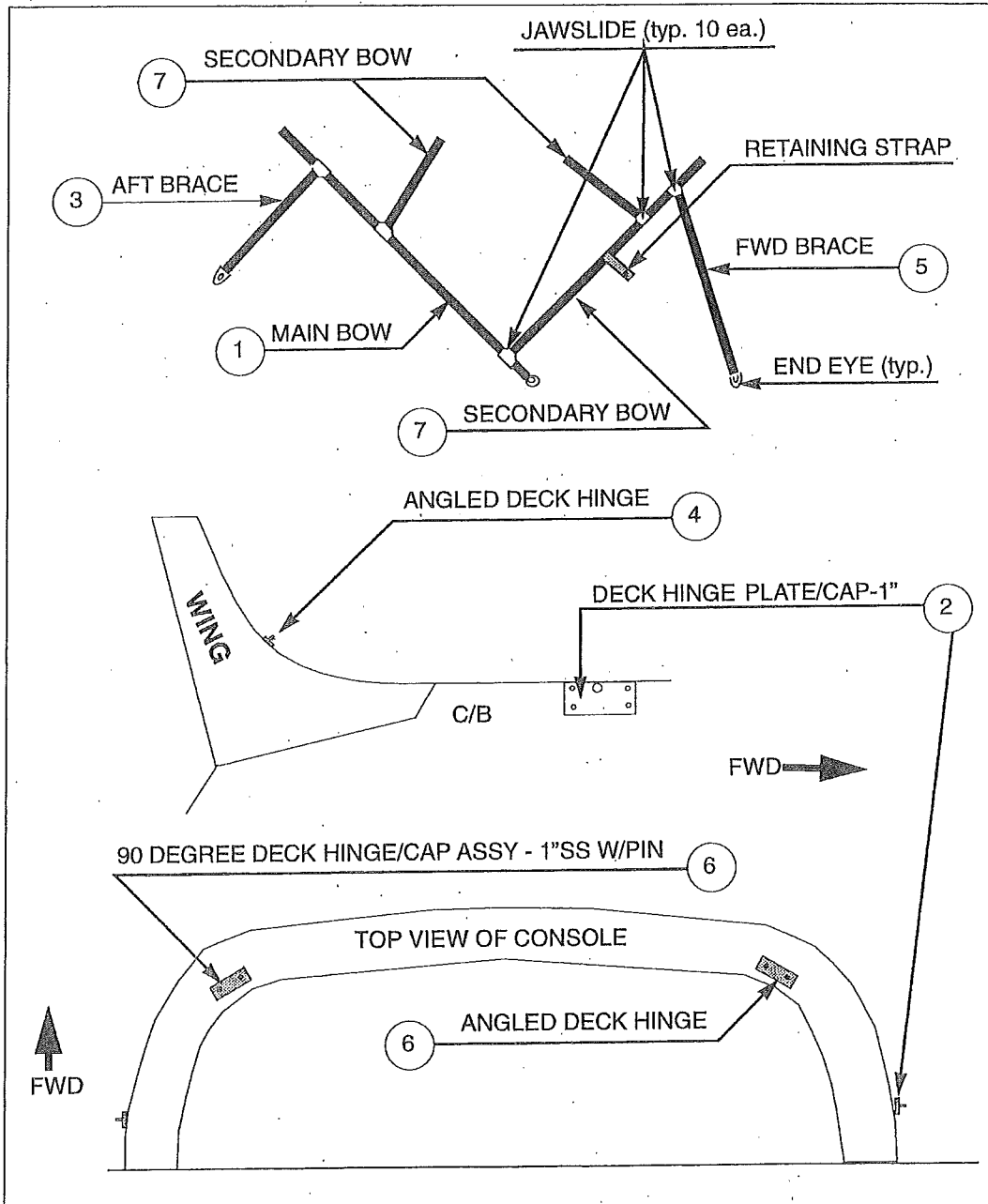

## GENERAL MAINTENANCE AND REPAIRS

In addition to instructions found elsewhere in this manual and in the literature specific to certain components, the following information is provided for general maintenance and repair.

Because conditions vary widely in different areas, and since frequency and type of use can differ greatly between owners, intervals for maintenance are not listed here. Common sense should determine the frequency of maintenance.

### Bilges/Engine Compartment

1. Pump the bilges dry and remove all loose dirt. Be sure all limber holes are open. If there is oil in the bilge and the source is not known, look for leaks in engine oil lines, coolers, transmission or engine gaskets. Oil stains can be removed by using a bilge cleaner available from your dealer or marina. **DO NOT** use flammable solvents.
2. Check all wiring to be sure it is properly supported, that its insulation is intact, and that there are no loose or corroded terminals. If there are corroded terminals, they should be replaced or thoroughly cleaned with sandpaper. Tighten all terminals securely and spray them with a light marine preservative oil.
3. Inspect the entire fuel system (including fill lines, vents, and supply and return lines) for any evidence of leakage. Any stains around joints could indicate a leak. Try a wrench on all fittings to be sure they are not loose, but do not overtighten them. Clean fuel filters and vent screens. Operate all valves to be sure they are in good condition. This is best performed by a qualified mechanic.
4. Inspect the entire bottom for evidence of seepage, damage or deterioration, paying particular attention to hull fittings, hoses, and clamps. Straighten kinked hoses and replace any that do not feel pliable. Tighten loose hose clamps and replace those that are corroded. Tighten any loose nuts, bolts, or screws. Operate seacocks to be sure they are in good condition. Seacocks need lubrication to ensure a long working life.
5. Refer to your engine operating manual for engine maintenance details. Wipe off engines to remove accumulated dust and grease. If a solvent is used, make sure it is nonflammable. Go over the entire engine and tighten loose nuts, bolts, and screws, including the mounts (however, do not turn the mount adjusting screws). Inspect the wiring on the engine and clean and tighten the terminals. Inspect the belts and tighten them if needed. Replace any belt that is cracked or frayed. Clean and lubricate the battery terminals; fill the cells with distilled water as needed.

## Cabin and Toppers Areas

1. Test all electrical equipment and appliances to make sure they operate properly. Inspect all wiring for proper support, sound insulation and tight terminals. Pay particular attention to portable appliance cords and plugs.
2. Inspect and operate heads, basins, showers and sinks. Also, inspect the freshwater system plumbing, including the tank. Check and operate the water pumps, including the shower pump and the sink drain pumps. Check all water lines and connections for leaks, and make sure all connections are tight.
3. Check bow rails, ladders, and grab rails for loose screws, breaks, sharp edges, etc. that might be hazardous in rough weather. Inventory and inspect life jackets for tears and deterioration. Check your first aid kit to make sure it is complete. Check the signaling equipment. Inspect anchor, mooring and towing lines and repair or replace as required. **DO NOT** stow wet lines as they may mildew and rot.
4. Salt and brackish water are capable of etching and damaging window glass. Keeping windows clean is the best preventive measure you can take. When window cleaning, flush with plenty of fresh water.  

Exercise caution when cleaning windows and doors made of plexiglass because it tends to scratch easily. First, use generous amounts of water to wash off as much dust as possible. Use your bare hands with plenty of water to dislodge any caked dirt. Then use a soft, grit-free cloth or clean, soft sponge with a cleaner made specifically for plexiglass. Never use a glass cleaning solution or a duster, as these will scratch the surface. **DO NOT** use solvents such as acetone, kerosene, benzene, carbon tetrachloride, fire extinguisher fluid, dry cleaning fluid, or lacquer thinner since they will attack the surface. When you are finished, rinse with fresh water and dry with a clean, damp chamois using a blotting action.
5. Your interior teak, with the exception of the galley floor, has been finished with TK 200 Teak Protectant/Restorer from Target Enterprises, Bayliner Part Number 55059.

The procedure for use of the Protectant/Restorer is as follows:

- Sand the teak lightly and remove the dust.
- Apply the teak finish to the teak with a foam brush.
- Sand lightly and remove the dust.
- Apply a final coat of teak finish with a damp rag.

The galley floor has been finished with WB2020 Interior Gloss Finish with CL20 Cross-Linker added from Target Enterprises, Bayliner Part Number 55237-B and 55237-A. The procedure for use of the Interior Gloss Finish is as follows:

- Mix the floor finish at the rate of 10cc's of Part B per 1 cup of Part A (4% as per the manufacturer's instructions).
- Lightly sand the floor and wipe off the dust.
- Apply a heavy coat of floor finish with a foam brush.
- Allow the finish to dry.
- Sand lightly with 220 grit sandpaper to remove any raised grain and remove the dust.
- Apply another coat of floor finish with a foam brush.
- Sand lightly and remove the dust.
- Apply a final coat of floor finish with a foam brush.

Optional interior ash: Any damaged part should be removed and replaced. When this is not practical, touch-up work should be performed by a highly skilled person. The following procedure was developed for veneer or hard stock:

- Keep surrounding areas covered at all times to prevent overspray damage.
- Lightly sand the entire damaged part with 220 grit sandpaper to rough-up the top coat.
- Using 220/320 grit, sand the area again, feathering one inch beyond the damaged area.
- Fill the damaged wood with matching color putty stick if necessary.
- Use a cotton swab or the corner of a one inch foam brush to sparingly apply touch-up stain (part # 60259).
- The repaired area should now be slightly lighter in color than the surrounding area and will darken during application of the matte finish later in this procedure.
- Allow the stain to dry for at least 30 minutes (slightly longer if cooler than 65 degrees).
- Sand the re-stained area with 600 grit to smooth-up the surface.
- Wipe the sanded area with a water dampened rag or vacuum to remove the dust.
- Use a Binks #15 spray gun or equivalent to apply one coat of matte finish (part # 60000) over the stained area.
- Allow to dry for one hour.
- Sand sprayed area with 600 grit and remove dust with a water dampened rag or vacuum.
- Spray the entire part with one coat of matte finish (part # 60000).

6. Stainless steel railings and fittings should be cleaned with soap and water or household glass cleaner. Because irreversible pitting will develop under rust that remains on stainless steel for any period of time, it is best to remove rust spots immediately with brass, silver or chrome cleaner. Then coat the railing or fitting with a good automobile or boat wax. Never clean with mineral acids or bleaches. Also, do not allow stainless steel to come into continuous contact with iron, steel or other metals which could cause contamination leading to rust or corrosion.

7. A variety of high quality fabrics have been used in the construction of your boat. Proper care and cleaning of all fabrics on a regular basis will contribute to their long life. The most important thing to remember is that stains must be cleaned up immediately if the original beauty and strength of the fabric are to be maintained over a long period of time. Independent laboratory testing has shown that some sunscreen lotions and oils can permanently stain most types of vinyls and fabrics, so exercise care when using these products.

Prior to cleaning any fabric, we suggest that you test your cleaning solution and method on a hidden or inconspicuous area. That way, if that particular cleaning method causes damage, it will be confined to a small, less noticeable area.

Use a sponge or very soft scrub brush and a mild soap and warm water solution to clean exterior fabrics. Rinse after scrubbing with plenty of cold, clean water and allow the fabric to air dry in a well ventilated place, preferably away from direct sunlight.

Convertible tops and vinyl upholstery can be cleaned using a mild soap and warm water solution also. Rinse after scrubbing with plenty of cold, clean water and air dry in a well ventilated place, again preferably away from direct sunlight. For detailed vinyl cleaning instructions see the Nautolex® insert in your owner's packet.

Vinyl cleaners and conditioners are NOT recommended for use on Bayliner upholstery, as they tend to remove plasticizers that extend the life of the fabric. To prevent rainwater seepage at the seams, a coating of Scotch Gard®, or similar water repellent, can be applied.

Mildew can occur if your boat does not have adequate ventilation. Heat alone will not prevent mildew; you must also provide for fresh air circulation. If mildew does occur, it often can be removed using a solution of warm water and laundry bleach (one cup of bleach to one gallon of warm water). Brush the solution into the affected area, let it sit for 10 to 15 minutes, and rinse with plenty of cold, clean water. Air dry in a well ventilated place, once again preferably away from direct sunlight.

If at all possible, the vinyl top parts of your boat should be stored indoors in a fairly warm, dry place. This will greatly extend the life of the material.

Dry cleaning should be considered for interior fabrics other than vinyl.

8. When marine instruments are exposed to a saltwater environment, salt crystals may form on the bezel and the plastic covers. These salt crystals should be removed with a soft, damp cloth; never use abrasives or rough, dirty cloths to wipe plastic parts. Mild household detergents or plastic cleaners can be used to keep the instruments bright and clean.

## Hull

1. The finish on a fiberglass boat is similar to that of an automobile and will respond to the same system of care and cleaning.

Use a sponge and a mild soap and warm water solution to clean exterior surfaces of your boat. Rinse the boat well with plenty of clean water. Use a quality boat wax to protect the finish. Note that there are a variety of polishes and cleaners for fiberglass on the market. We suggest that you experiment with different brands to determine which work best for you.

2. Almost unavoidable during the life of your boat is damage to the gelcoat or colored surface. This is not as serious as you might think. Repair is not costly and can be done by the novice.

**Scratches:** If the scratch does not penetrate the gelcoat surface, it can be repaired with automotive rubbing compound. Dampen a soft rag and apply the compound with a continuous circular motion. The scratch may not disappear completely; however, its noticeability will decrease.

**Gouges and Chips:** To repair, obtain "patch paste" from your Bayliner boat dealer and follow this recommended procedure:

- Clean the area to be repaired of wax and oil. Acetone is a good solvent.  
Mix a small portion of patch paste and catalyst according to the manufacturer's instructions.
- Apply the paste to the gouge with a putty knife or flat-edged stick; try to match the paste to the surface contour of the area being repaired. It is better to have an excess of paste, rather than not enough.
- Allow the paste to harden thoroughly. In most climates, one to two hours should be sufficient.
- Shape the patch as desired, using fine wet sandpaper.
- Finish by using automotive rubbing compound in the same manner as you did for small scratches.

## ▲ WARNING

**Teak oil, acetone and catalyst are hazardous materials and should be used only in well ventilated areas. Follow the manufacturer's instructions. Also, never store rags that have been wetted with acetone, teak oil, fuel or any other solvent aboard your boat. Immediately remove them from the boat and discard them properly to prevent spontaneous combustion and fire.**

3. The bottom paint on your boat is designed to dissolve slowly to prevent marine growth. Therefore, it is unusual to find a boat bottom that does not need repainting after a season's use. Your boat is bottom painted at the factory with International Paint Company's Interlux Fiberglass Bottom Kote #779 Black.

Periodically haul the boat out of the water and scrub the bottom with a bristle brush and a solution of soap and water. It is not always necessary to repaint the bottom each time it is scrubbed, but no bare spots should be permitted.

The recommended procedure for repainting the bottom is as follows:

- Prepare the bottom by sanding, cleaning and fairing as required.
- It is imperative that the new paint be applied over a perfectly dry surface. Fiberglass hulls should never be hauled, painted and relaunched on the same day, since this does not allow sufficient time for the moisture which has been absorbed into the old paint to completely dry out. Generally, 24 - 36 hours of drying time is required.

## NOTICE

**Bayliner recommends the application of an epoxy barrier coating, such as International Paint Company's Interlux "Interprotect 2000 or 3000 Systems®", to help seal the hull bottom and reduce the possibility of gelcoat blistering on any boat that is moored. The barrier coating should be covered with several coats of antifouling paint. Note that many states regulate the chemical content of bottom paints in order to meet environmental standards. Check with your local Bayliner boat dealer about recommended bottom paints, and about laws that are in effect in your area.**

4. Whenever your boat is out of the water you should check all metal parts for stray current corrosion. Stray

current corrosion, or electrolysis, can be prevented several ways. The following are the most common causes and the simplest cures:

- Wiring may leak a certain amount of electricity. Keep a clean, dry bilge.
- A poorly grounded zinc anode: Check the ground wire and clean the contact surfaces.
- The zinc anode may be deteriorated beyond effectiveness; replace it when it has deteriorated 50% or more.
- If your boat is permanently moored, we recommend that you contact someone in your area specializing in corrosion control and have them check your boat in its moorage to see that it is properly protected.

Also, while your boat is out of the water, propellers, should be inspected for damage.

5. Every attempt has been made to equip your boat with propellers that will optimize performance. Changes in altitude and load can affect performance; therefore, your boating needs may dictate a propeller change. Your Bayliner boat dealer can help you in the selection of propellers better suited to your needs.
6. Flapper valves on cockpit scuppers should be checked often to see that they are pliable and are providing the proper sealing action.

## STORAGE

---

The following suggestions are offered for storage at the end of your boating season:

1. If your boat is to be stored out of the water, it is extremely important that its hull is properly supported to avoid permanent hull distortion. If your boat is stored inside, it should be in a well-ventilated building. (Refer to the "Sling Locations" drawing which depicts the proper placement for the slings used to lift your boat. In addition to sling placement, it is important to use the proper spreader beams that place the slings vertical at the lift points).
2. A temporary winter cover is recommended if covered storage isn't available. A proper winter cover should keep the weather off the boat, but still provide adequate ventilation. Wrapping a boat in a tight plastic cover can do more damage than good. Dampness and lack of air circulation provide ideal conditions for the fungi that cause mildew and dry rot.
3. Fill the battery cells with distilled water to the proper level. A fully charged battery will survive storage better than one that is not.
4. Refer to your engine, generator, and accessory owner's manuals for specific storage instructions that apply to that particular component.

5. Drain the freshwater tank and lines by opening all faucets and operating the water pump (be sure that the hot water tank power switch is turned OFF). Operate the pump until all tanks and lines are empty and no water flows from any of the faucets. Then drain the pump to prevent damage that can result from freezing. Remove the caps from both hot and cold lines to allow any remaining water to drain into the bilge and then overboard through the bilge pumps.
6. Flush the head several times. If the boat is to be stored in saltwater, close the intake seacock, add fresh water to the bowl and allow it to stand for a day or more to dissolve accumulated salt. Then, with the seacock closed, flush the head until it is pumped dry. Pump out the holding tank.
7. Where freezing temperatures are likely you may want to use an RV antifreeze in the water systems following the manufacturer's instructions.
8. Fuel tanks should be filled so there is little air space, thereby minimizing condensation.
9. Refer to your engine owner's manual for storage procedures related to the engine seawater cooling system. (Generator cooling system storage provisions are similar to those used for the main engines).
10. Thoroughly clean your boat. If possible, remove cushions, mattresses, blankets, towels, and other items that can hold moisture and cause mildew. Such items left on board should be positioned for maximum air circulation. It helps to stand mattresses and cushions on edge. Prop open doors, hatches, cabinets and ski lockers to allow fresh air to circulate.
11. Defrost and dry out the refrigerator and freezer; leave the doors propped open. Leave all drawers and locker doors open.
12. Clean all deck hardware; then coat the hardware with rust inhibitor.
13. Lubricate the steering mechanism and throttle control linkage.
14. Close all seacocks.
15. Provide as much heat and ventilation for interior spaces as is safe and practical.

We hope these preventive measures will help make getting ready again in the spring easier. Should you have any questions, your Bayliner boat dealer is ready to provide assistance.



## NAUTICAL TERMS

- ABEAM:** ..... To one side of a vessel, at a right angle to the fore-and-aft line.
- AFT:** ..... Near or at the stern.
- BEAM:** ..... The width of the hull.
- BILGE:** ..... The lowest portion inside a boat (in a fiberglass boat, generally the under-deck and lower portion of the engine compartment).
- BOW:** ..... The forward portion of the boat.
- CHINE:** ..... The intersection of the side and bottom of a V-bottom boat.
- DRAFT:** ..... Vertical distance from the waterline of the boat to the lowest point of the boat.
- FATHOM:** ..... A measurement of six feet, generally used to measure water depth.
- FREEBOARD:** .... Vertical distance from the deck to the waterline.
- GUNWALE:** ..... The upper edge of the side of a boat.
- HATCH:** ..... A deck opening providing access to the space below. Normally fitted with a cover.
- HEAD:** ..... Toilet or toilet room.
- HELM:** ..... The tiller, wheel, and other steering gear.
- KEEL:** ..... The lowest external portion of the hull.
- KNOT:** ..... Nautical mile per hour; one nautical mile is 6,076 ft.; a land mile is 5,280 ft.
- LEE:** ..... The direction toward which the wind blows.
- PORT:** ..... To the left side of the boat facing forward.
- PORTLIGHT:** ..... A hinged window in the boat's cabin or hull.
- SCUPPER:** ..... An opening in a deck or cockpit permitting water to drain overboard.
- STANCHION:** .... A fixed, upright post used for support (of rails or lifelines).
- STARBOARD:** .... To the right side of the boat facing

# SYSTEMS DRAWINGS AND DIAGRAMS

## FRESH WATER SYSTEM

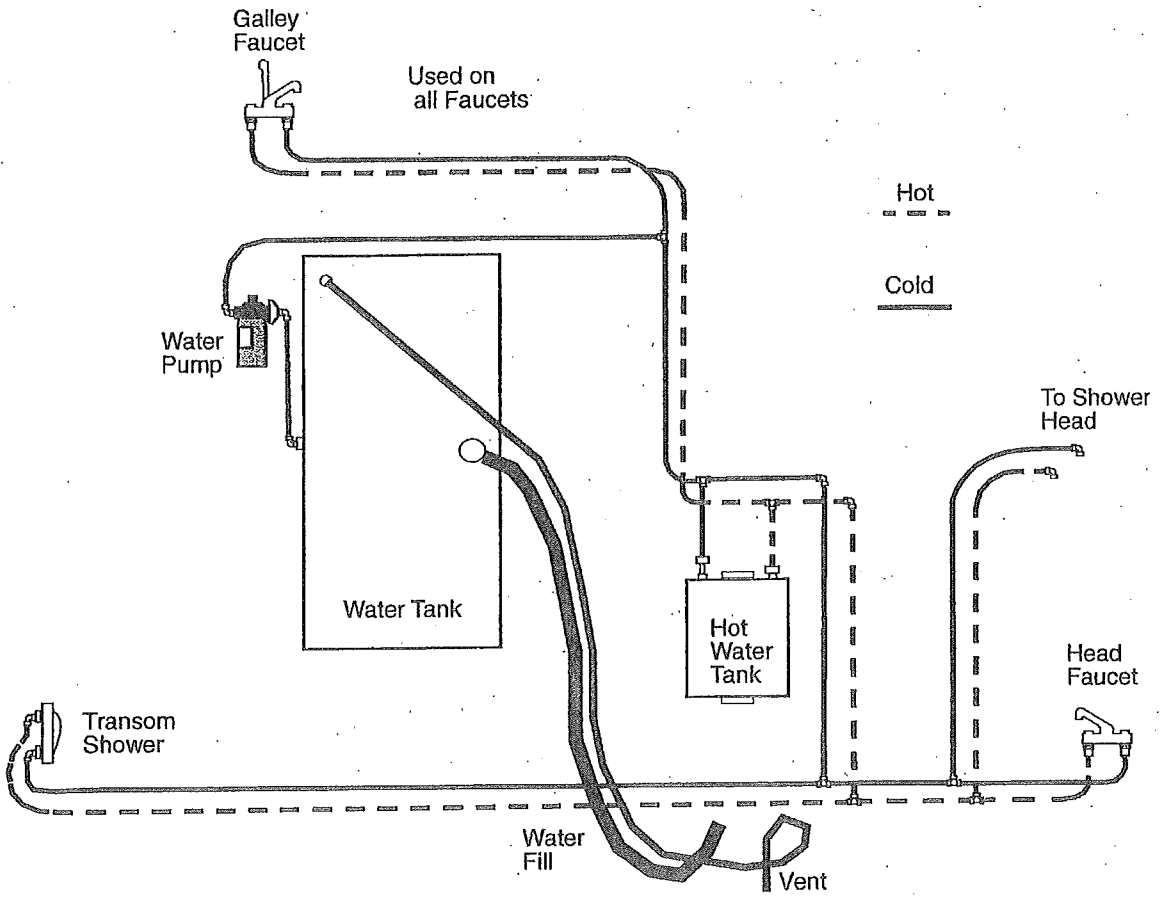
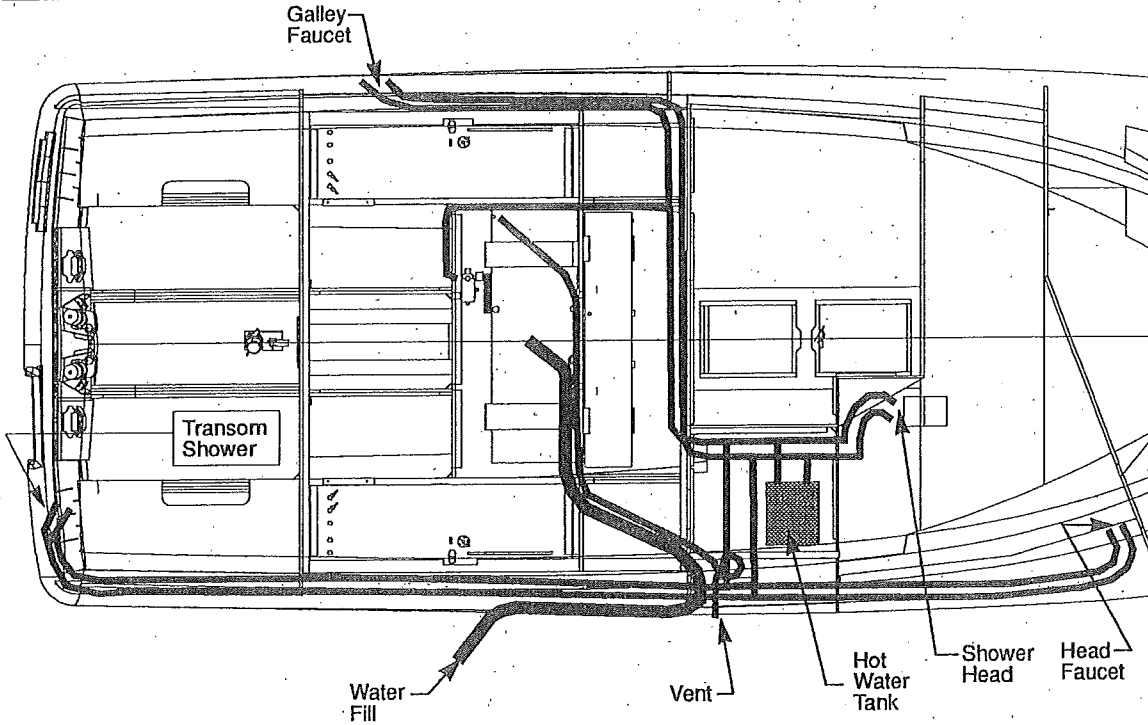

# Air Conditioning System

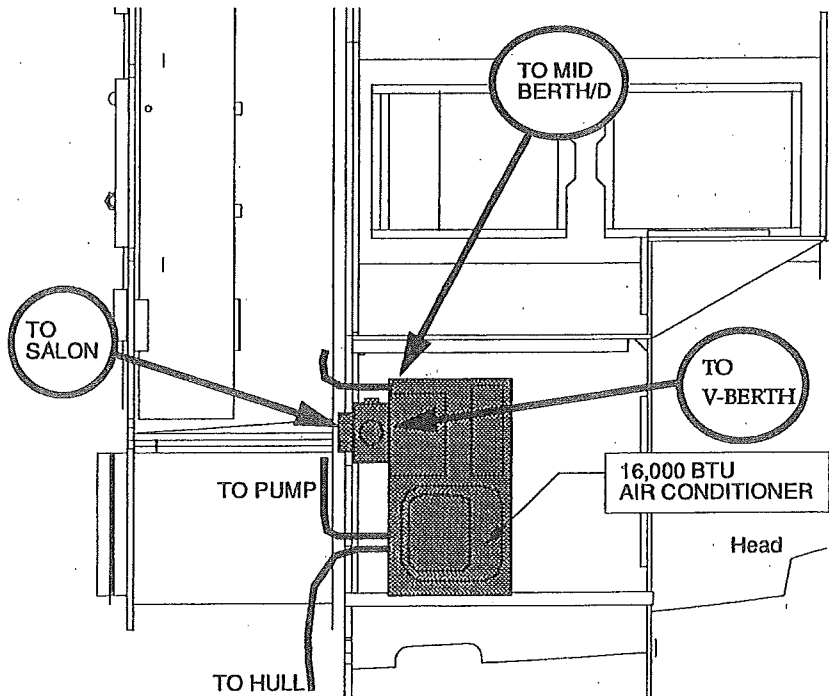
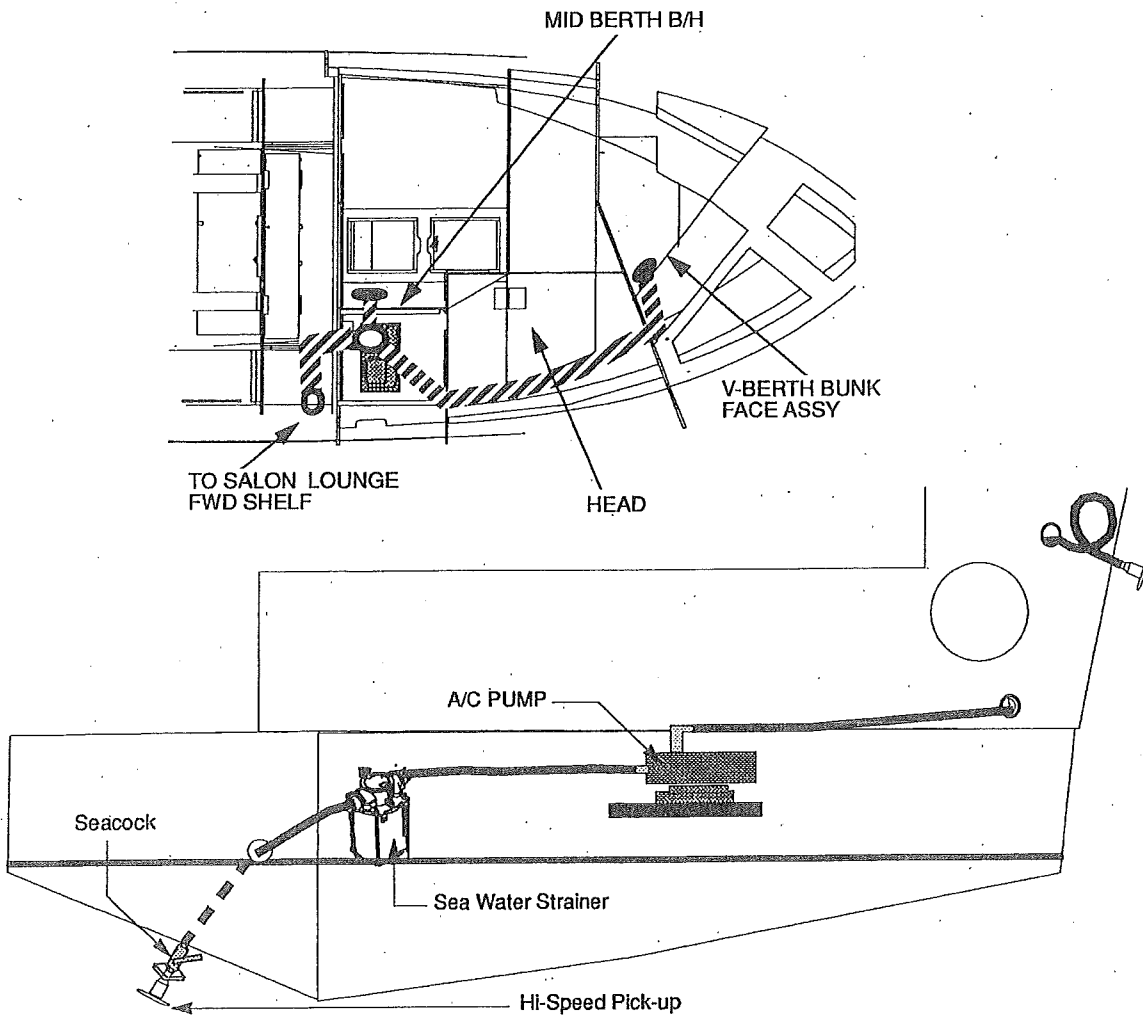

## Bilge System

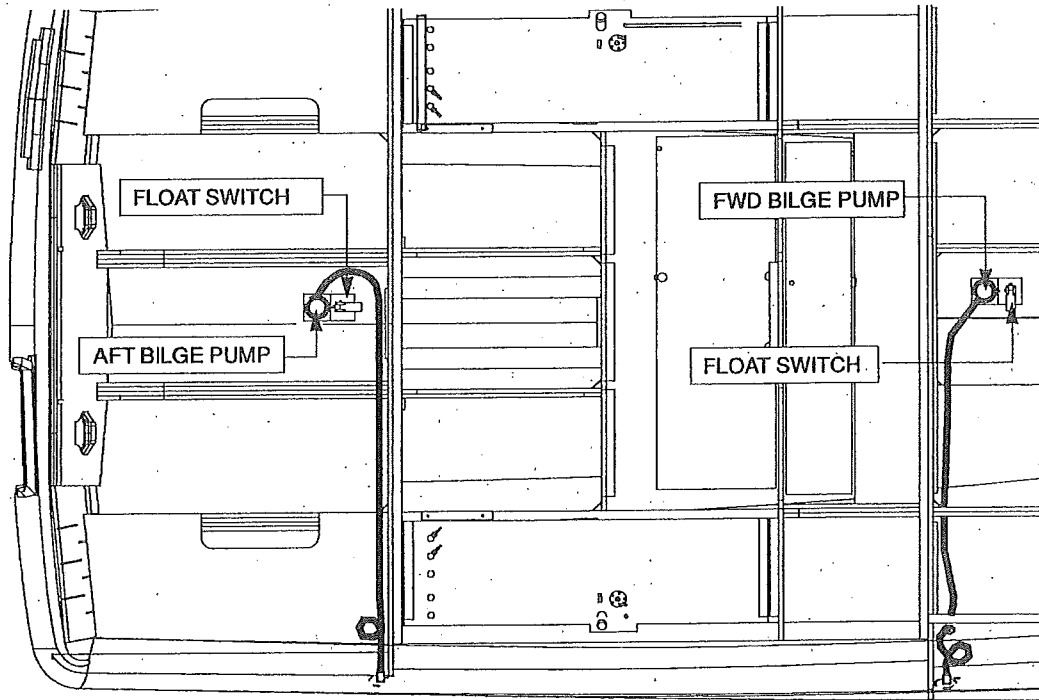

## Blower System

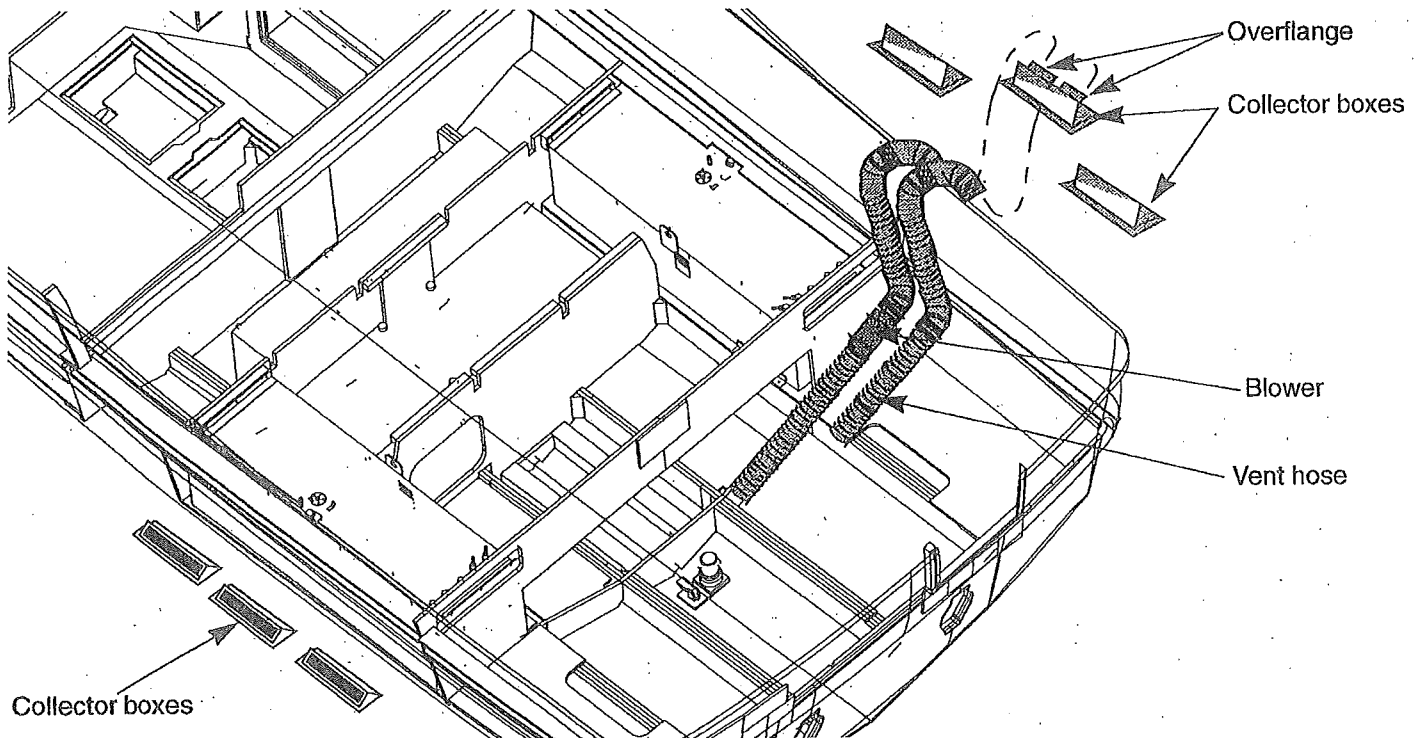

# Fuel System

Notes;  
1 - Port Side Shown, Stbd Side Typ.

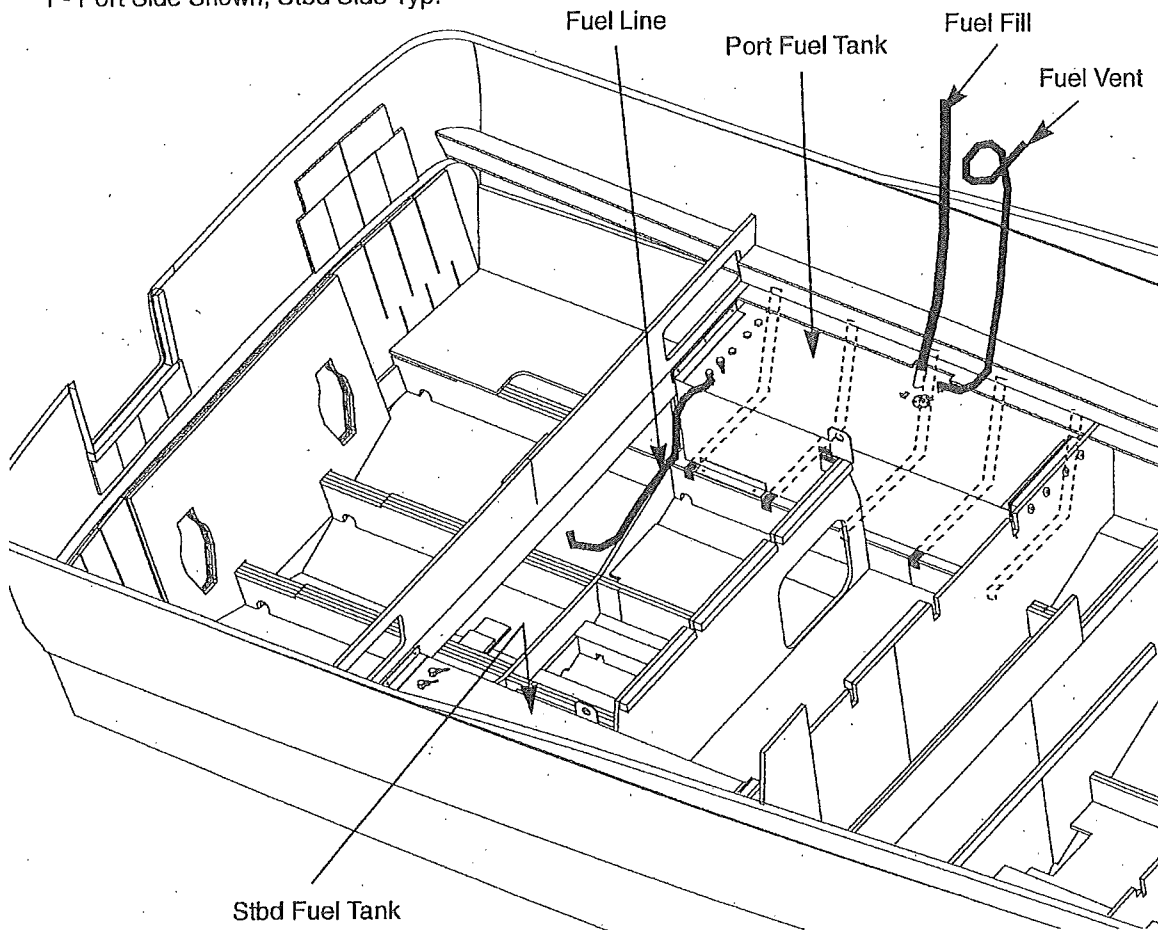

# Generator System(optional)

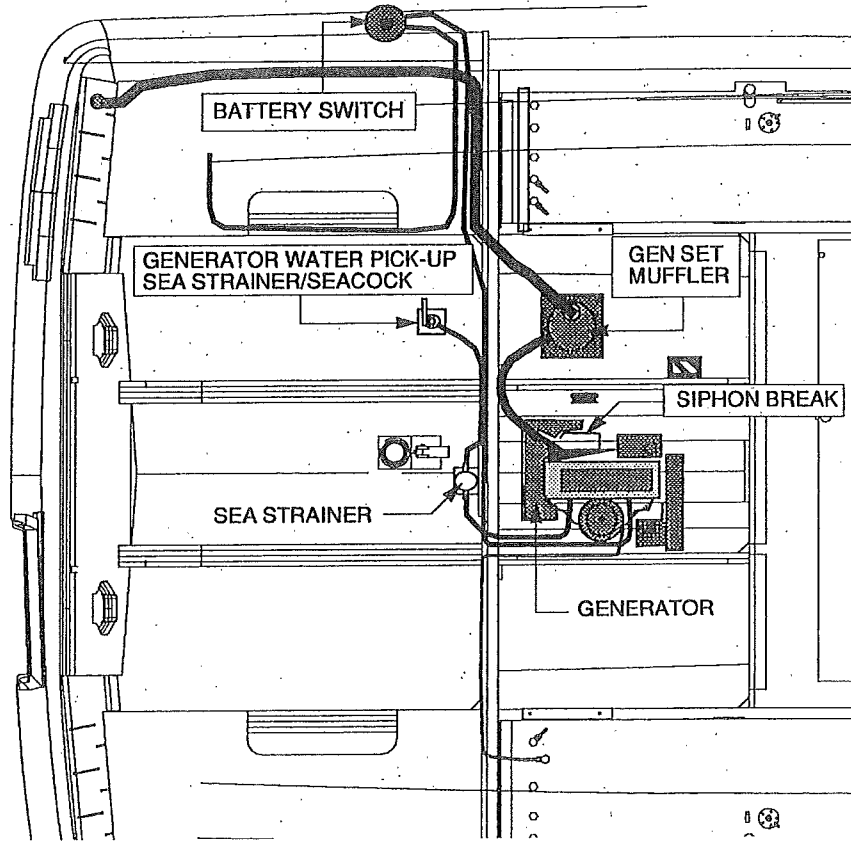



## Marine Head Water Pickup System

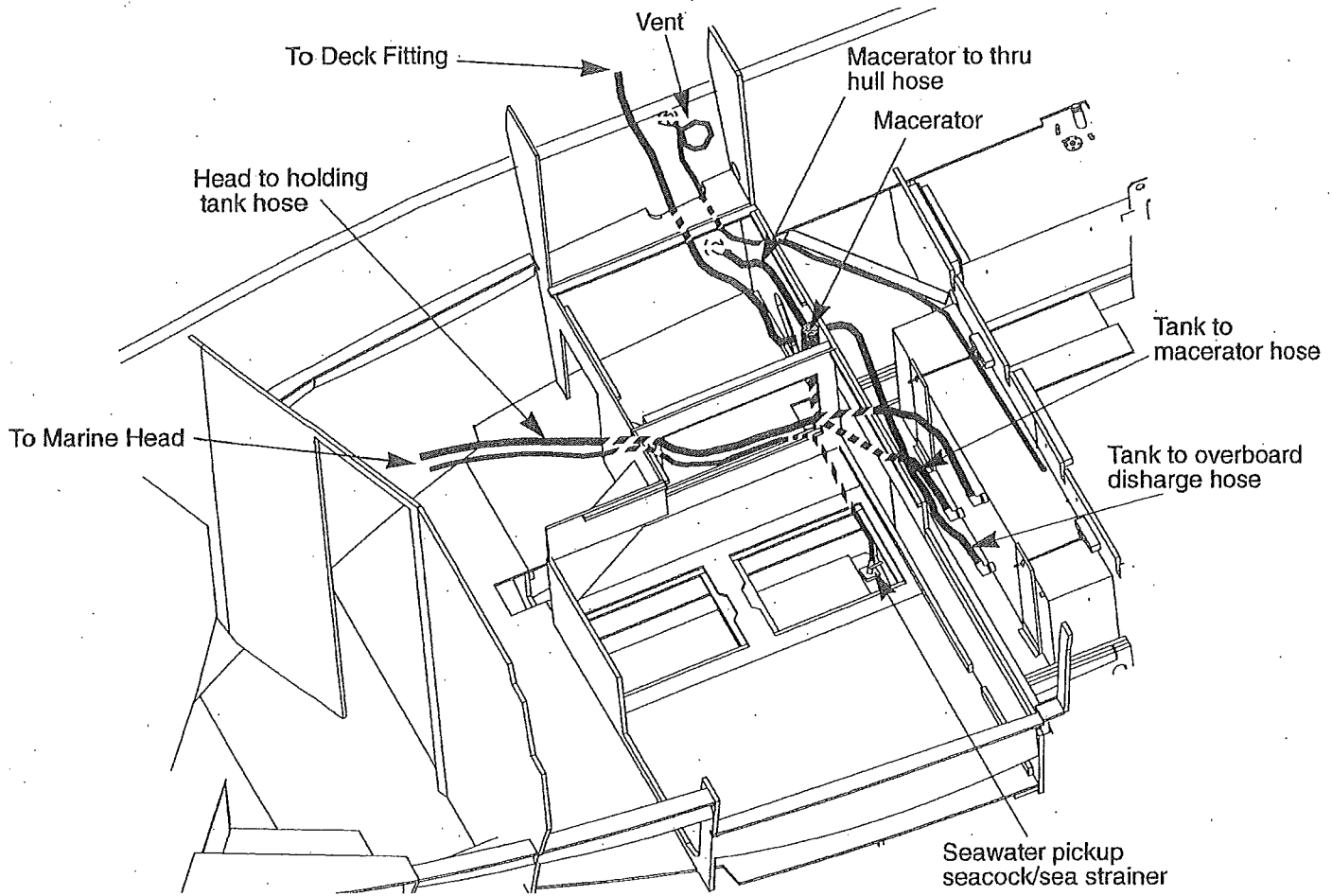

## Shower Drain System

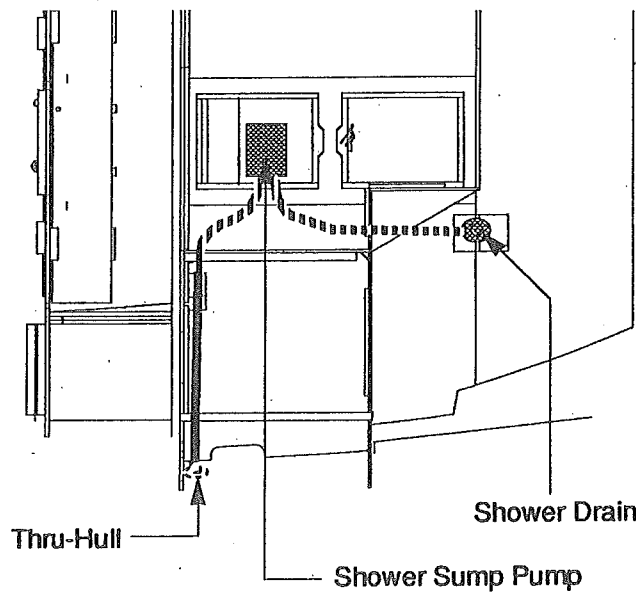





# DUAL DOCKSIDE WITH GENERATOR

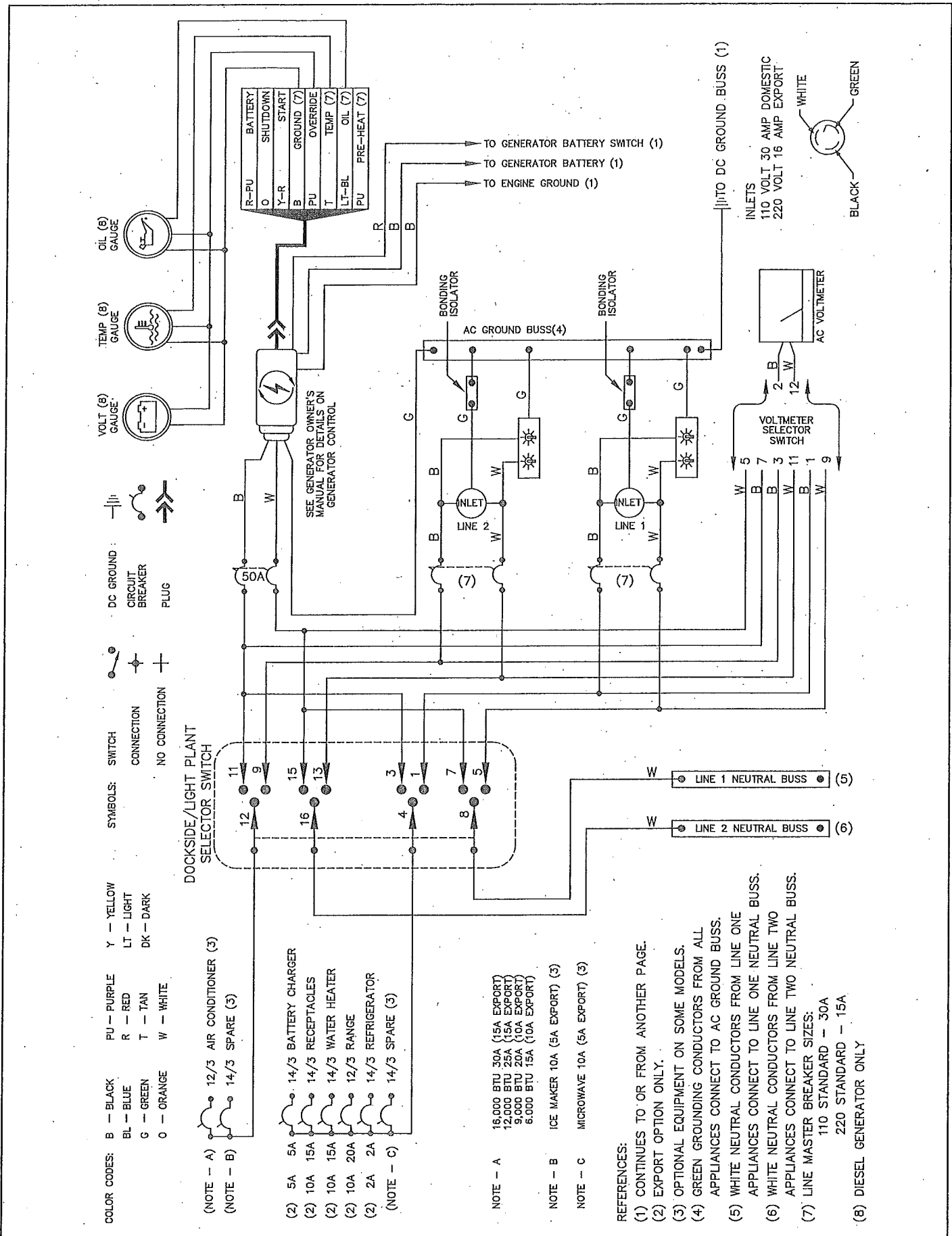

# DC ELECTRICAL SYSTEM

**NOTES:**

- (1) SOME ITEMS MAY HAVE SECONDARY OVERCURRENT PROTECTION AT THE UNIT.
- (2) MAY NOT BE INSTALLED ON ALL MODELS.
- (3) OPTIONAL EQUIPMENT ON SOME MODELS.
- (4) CONTINUES TO OR FROM ANOTHER PAGE
- (5) ALL DC GROUNDS ARE TIED TOGETHER AT THE ENGINES AND NOT NECESSARILY GROUPED AS SHOWN.
- (6) INDICATES SWITCHES LOCATED AT ALL CONTROL STATIONS.
- (7) SOME MODELS MAY HAVE ONLY TWO WIPERS.

**SYMBOLS:**

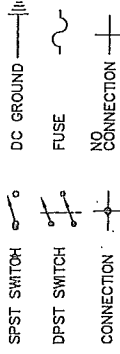

**COLOR CODES:**

- B - BLACK
- BL - BLUE
- BR - BROWN
- D - DARK
- G - GREEN
- GY - GRAY
- LT - LIGHT
- O - ORANGE
- P - PINK
- PU - PURPLE
- R - RED
- T - TAN
- W - WHITE
- Y - YELLOW

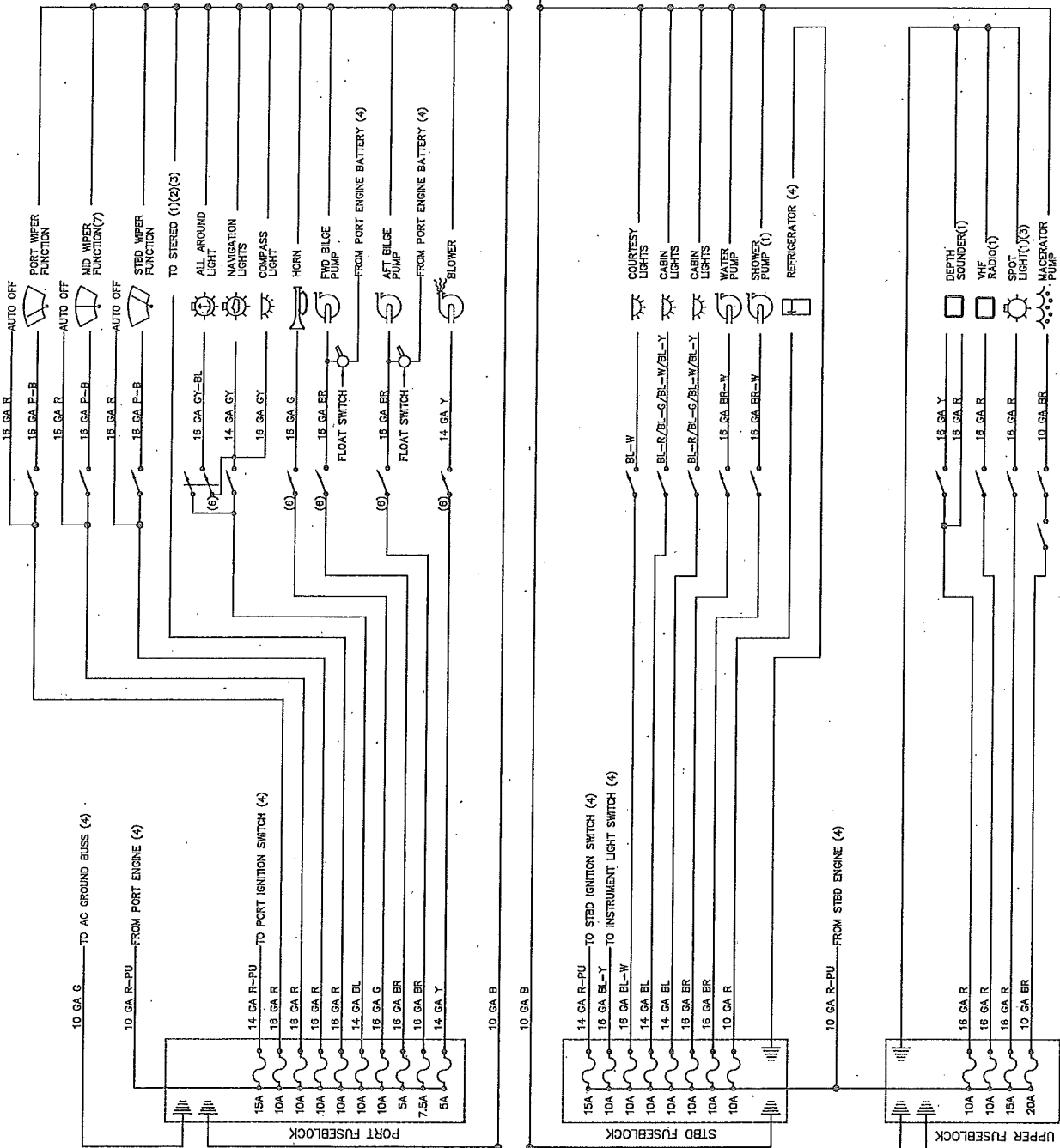



# DIESEL ENGINE ELECTRICAL SYSTEM

- NOTES:
- (1) START CIRCUIT NEUTRAL SAFETY AND EMERGENCY SHUTDOWN SWITCHES ARE LOCATED AT THE UPPER STATION ONLY.
  - (2) SOME ITEMS MAY HAVE SECONDARY OVERCURRENT PROTECTION AT THE UNIT.
  - (3) MAY NOT BE INSTALLED ON ALL MODELS (6) INSTALLED AT ONE STATION ONLY.
  - (4) OPTIONAL EQUIPMENT ON SOME MODELS (7) INSTALLED AT EACH STATION.
  - (5) CONTINUES TO OR FROM ANOTHER PAGE (6) INSTALLED AT UPPER STATION ONLY.

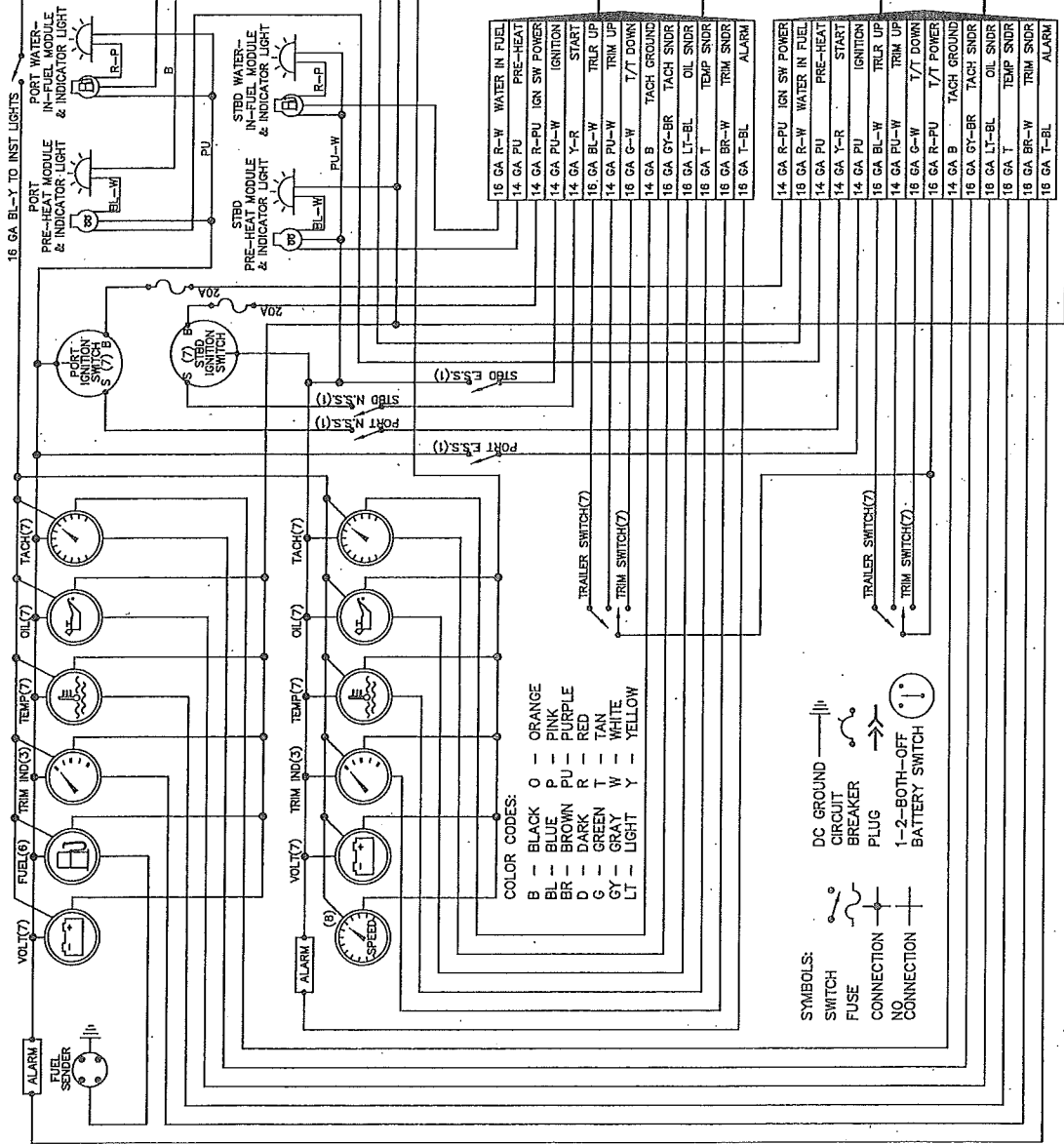



## LIMITED WARRANTY

---

Bayliner warrants to the original purchaser of its 1996 model boats, purchased from an authorized dealer, operated under normal, noncommercial use that the Selling Dealer will:

- A. Repair any structural hull defect which occurs within five (5) years of the date of delivery.
- B. Repair or replace any parts found to be defective in factory material or workmanship within one (1) year of the date of delivery.

## What Is Not Covered

---

**This warranty does not apply to:**

1. Engines, drive trains, controls, props, batteries, or other equipment or accessories carrying their own individual warranties;
2. Engines, parts or accessories not installed by US Marine;
3. Plexiglass windscreen breakage; rainwater leakage on Runabout models; rainwater leakage through convertible tops; minor gelcoat discoloration, cracks or crazing or air voids;
4. Hull blisters that form below the waterline;
5. Normal deterioration, i.e. wear, tear, or corrosion of hardware, vinyl, tops, vinyl and fabric upholstery, plastic, metal, wood, or trim tape;
6. Any Bayliner boat which has been overpowered according to the maximum horsepower specifications on the capacity plate provided on each Bayliner outboard boat;
7. Any Bayliner boat used for commercial purposes;
8. **Any defect caused by failure of the customer to provide reasonable care and maintenance.**

## Other Limitations

---

**THERE ARE NO OTHER EXPRESS WARRANTIES ON THIS BOAT. TO THE EXTENT ALLOWED BY LAW:**

1. Any implied warranty of merchantability is limited to the duration of this written warranty.
2. **Neither Bayliner nor the Selling Dealer shall have any responsibility for loss of use of the boat, loss of time, inconvenience, commercial loss or consequential damages.**
3. Some states do not allow limitations on how long any implied warranty lasts, so the above limitation may not apply to you. Some states do not allow the exclusion or limitation of incidental or consequential damages, so the above limitation or exclusion may not apply to you. This warranty gives you specific legal rights, and you may also have other rights which vary from state to state.

## Your Obligation

---

**In order to comply with Federal regulations, it is essential that your warranty registration card be submitted within 30 days of delivery of your boat. Return of this card is a condition precedent to warranty coverage. Before any warranty work is performed, we require that you contact your Selling Dealer to request warranty assistance.**

**We require that you return your boat, at your expense, to your Selling Dealer or, if necessary, to the Bayliner factory. You will be responsible for all transportation, haul outs and other expenses incurred in returning the boat for warranty service.**

**Bayliner Marine Corporation  
PO Box 9029  
Everett, WA 98206  
Phone (360) 435-5571**

**P/N 60905**