

# 4087 MOTORYACHT

---

1996 OWNER'S MANUAL

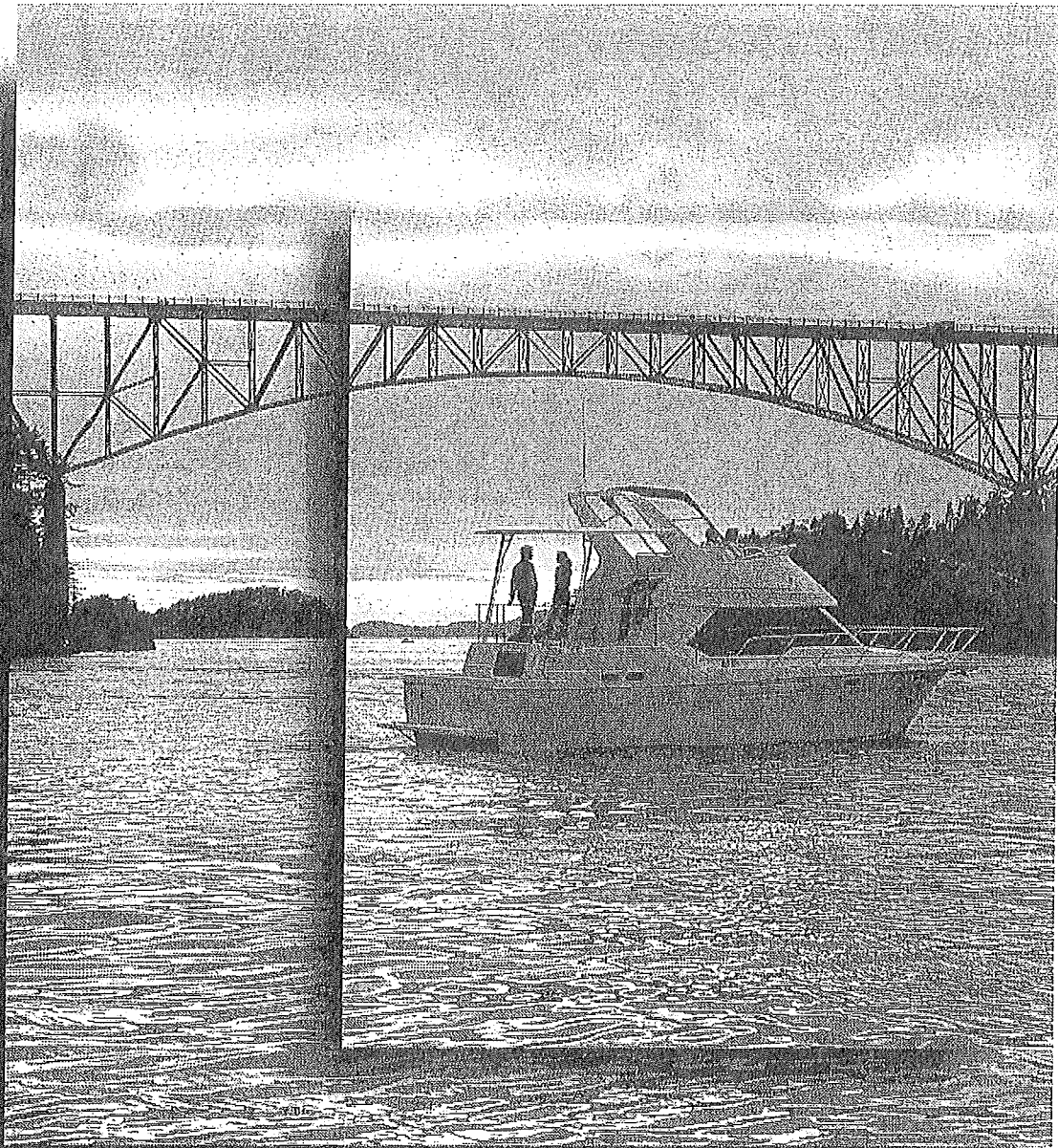

# BAYLINER<sup>®</sup>

Putting Quality First

The hazard warning symbols shown below are used throughout this manual to call attention to potentially dangerous situations which could lead to either personal injury or product damage. We urge you to read these warnings carefully and follow all safety recommendations.

**⚠ DANGER**

The symbol shown above alerts you to immediate hazards which **WILL** cause *severe personal injury or death* if the warning is ignored.

**⚠ WARNING**

The symbol shown above alerts you to hazards or unsafe practices which **COULD** result in *severe personal injury or death* if the warning is ignored.

**⚠ CAUTION**

The symbol shown above alerts you to hazards or unsafe practices which **COULD** result in *minor personal injury, or cause product or property damage* if the warning is ignored.

**NOTICE**

The symbol shown above calls attention to installation, operation or maintenance information which is important to proper operation, but is not hazard-related.

**⚠ WARNING**

**A qualified operator must be in control of the boat at all times. Do not operate your boat while under the influence of alcohol or drugs. Never operate your boat at speeds which exceed your ability to react if an emergency develops. At night, turn on the appropriate running lights and cruise at a reduced speed that will allow you plenty of time to avoid dangerous situations.**

**⚠ WARNING**

**Manufactured with 1,1,1-Trichloroethane, a substance which harms public health and environment by destroying ozone in the upper atmosphere.**

## WELCOME ABOARD

This manual has been prepared to assist you in the operation and care of your Bayliner 4087 Motoryacht. Please read through it completely, as familiarization with its contents can contribute to the safe and effective operation of your yacht.

Your Motoryacht's engines and accessories were selected to provide optimum performance and utility. Installation of different engines or other accessories may cause undesirable handling characteristics. Should you choose to install different engines, or to add accessories that will affect the boat's running trim, have an experienced marine technician perform a safety inspection and a handling test before operating your yacht by yourself again.

Your yacht's mechanical and electrical systems were designed to meet safety standards in effect at the time it was constructed. Some of these standards were mandated by Federal law, others are considered industry norms. All of them were designed to insure your safety, and the safety of other people, vessels and property around you. To maintain the integrity and safety of your yacht, only qualified people should perform maintenance on, or in any way modify, the steering system, propulsion system, engine control system, fuel system, environmental control system, or electrical system. Failure to maintain these systems as designed could violate Federal law, and could expose you and other people to the danger of bodily injury or accidental death. We recommend that you follow the instructions provided in this handbook, in the engine owner's manual, and in the accessory instruction sheets included with your yacht. We also recommend that you perform the following steps:

1. Make certain that you receive a full explanation of all systems from the dealer before taking delivery of your yacht. Your selling dealer is your key to service. If you experience any problems with your new Bayliner, immediately contact the dealership. If for any reason your selling dealer is unable to help, call us direct on our customer service hotline for assistance. The number is (360) 435-8957.
2. Read this manual thoroughly, paying particular attention to the subjects of **fueling, checking for fumes, starting, carbon monoxide, loading limits, trim tabs, recommendations for safety, and warranty.**
3. Practice—all members of the family should be familiar with the operation and systems of your yacht.
4. Participate in a safe boating course. Call the local office of the United States Power Squadrons or the United States Coast Guard Auxiliary for the date and location of their next class.

# Contents

---

WELCOME ABOARD .....	1	COMPONENTS/SYSTEMS .....	15
PREPARATION .....	5	Electrical System (12-Volt DC) .....	15
Recommendations for Safety .....	5	Electrical System (110-Volt AC) .....	17
Trim .....	6	Optional Generator .....	17
Other Tips .....	6	Water Heater .....	18
Safety Equipment .....	7	Air Conditioning/Heating (Optional) ...	18
Tool Chest .....	7	Anchor Winch (Optional) .....	18
Miscellaneous Items .....	7	Fuel System .....	19
OPERATING .....	8	Shaft-Transmission Alignment .....	20
Launching .....	8	Shaft Log Stuffing Box Packing .....	20
Fueling Procedures .....	8	Rudder Stuffing Gland .....	20
Prestart Inspection .....	8	Stove .....	20
Starting Procedure (Diesel Engines) ..	9	Microwave Oven .....	21
Starting Procedure (Gas Engines) .....	9	Steering .....	21
Engine Performance Changes .....	10	Spotlight (Optional) .....	22
Carbon Monoxide (CO2) .....	10	Refrigerator .....	22
Before You Leave .....	11	Seawater Strainers .....	22
Maneuvering .....	11	Exhaust System .....	22
Basic Maneuvering .....	11	Potable Water System .....	22
Docking .....	11	Marine Head System .....	22
Towing .....	12	Bilge Pumps .....	23
Boat Performance .....	12	Stereo .....	24
Boat Running Trim .....	12	Depth Sounder .....	24
Trim Tabs .....	13	GENERAL MAINTENANCE	
Instruments .....	13	AND REPAIRS .....	25
Grounding .....	13	Bilges/Engine Compartment .....	25
Dual Station Operation .....	14	Cabin and Topside Areas .....	25
Structural Limitations .....	14	Hull .....	27
Engine Shut-Down .....	14	STORAGE .....	28
		NAUTICAL TERMS .....	29
		DRAWINGS AND DIAGRAMS .....	30
		WIRING DIAGRAMS .....	39
		LIMITED WARRANTY .....	44

## PREPARATION

Prior to leaving on your first outing (or, for that matter, any outing) there are certain items to check and activities to perform. Beside reading this manual and your engine manual, familiarize yourself with your yacht while dockside, and consider the following suggestions:

### Recommendations for Safety

#### 1. Personal Flotation Devices:

One Coast Guard approved personal flotation device (PFD) of suitable size is required for each person aboard a recreational boat. New PFDs bearing Coast Guard approval are now identified as Types I, II, III, or IV.

Requirements for boats sixteen feet (16') or over in length: One (1) Type I, II, or III (wearable) PFD for each person on board, and one (1) Type IV (throwable) PFD in each boat.

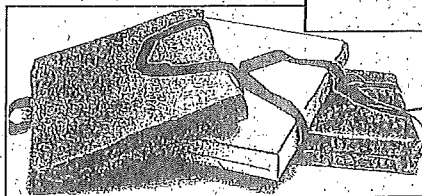

TYPE II

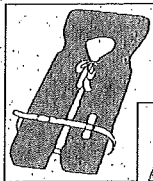

TYPE I

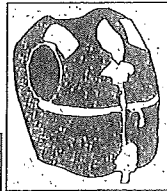

TYPE III

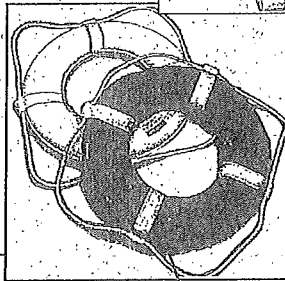
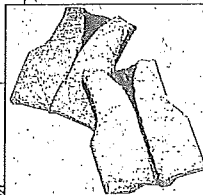

TYPE IV  
THROWABLE

- Always have children wear PFDs. Always check those devices intended for young children for fit and performance in the water. Never hesitate to have "all hands" wear life-saving devices whenever circumstances cause the slightest doubt about safety.
- If a U.S. Coast Guard capacity placard is attached to your boat do not exceed the load specified and take care to properly load your boat. Maintain adequate



freeboard at all times. Consider the sea conditions, the duration of the trip, the weather and the experience of the personnel on board.

- The operator of the boat is responsible for the safety of his passengers as well as his own. You should insure that everyone aboard is properly and securely seated in appropriate seating locations before starting. You should not allow sitting on seatbacks; gunnels, bows, transoms, fishing seats, or sun lounges while underway. In many states it is illegal.

### **⚠ DANGER**

Do not allow anyone to ride on parts of the boat that were not designed for such use. Sitting up on seat backs; bow riding, gunwale riding, transom platform riding, or lounging on forward deck while underway is especially hazardous and will cause personal injury or death.

### **⚠ WARNING**

Do not allow anyone to occupy the transom platform while the engines are operating (this applies even when the shifters are in neutral).

- Falls are the greatest cause of injury both afloat and ashore. Eliminate tripping hazards where possible, make conspicuous those that must remain, and require that everybody on board wear proper footwear.
- Boat operators are required by law to file a Boating Accident Report with their state boating law enforcement agency when their boat is involved in certain boating accidents. A boating accident must be reported if (1) there is loss of life or probable loss of life, or (2) there is personal injury requiring medical treatment beyond first aid, or (3) there is property damage to boats or other property where the damage value exceeds \$500.00, or (4) there is complete loss of the boat. For further information and assistance contact the local law enforcement authorities.
- Never drive the boat directly behind a water skier. At 25 m.p.h. the boat will overtake a fallen skier who was 200 feet in front in 5 seconds.
- Understand the meanings of navigation buoys, and never moor to one. (It is a Federal offense.)
- Know the various distress signals. A recognized distress signal used on small boats is to slowly and repeatedly raise and lower the arms outstretched to each side.
- Storm signals are for your information and safety. Learn them and be guided accordingly.
- A special flag (red flag with a white diagonal stripe or blue and white International Alpha) flown from a boat

or buoy means diving operations are underway nearby. Approach with caution and stay clear by at least 25 yards.

12. **ALWAYS** shut the engines OFF and remove the keys from the ignition switches before allowing anyone to occupy the transom platform, lower the boarding ladder or swim anywhere near your boat. Also, slow down and exercise extreme caution any time you are cruising in an area where there might be swimmers or water skiers in the water. **NEVER** back up to anyone in the water.
13. Watch your wake. It might capsize a small craft. You are responsible for damage caused by your wake. Pass through anchorages at a minimum speed.
14. Learn and abide by common boating "rules of the road".
15. Always have up-to-date charts of your cruising area on board.
16. Keep an alert lookout. The operator is required by law to "maintain a proper lookout by sight (and hearing). He must insist that he has an unobstructed view particularly to the front. No passengers, load or fishing seats should block his view when operating the boat above idle speed.
17. Always instruct at least one person on board in the rudiments of boat handling in case you are disabled or fall overboard.
18. Consider what action you would take under various emergency conditions such as a person overboard, fog, fire, a damaged hull or other bad leaks, engine breakdown, severe storm or collision.
19. If your boat ever capsizes, remember that if it continues to float, it is usually best to remain with it. You are more easily located by a search plane or boat.
20. Keep firefighting and lifesaving equipment in good condition and readily available at all times.
21. Do not test fire extinguishers by squirting small amounts of the agent. The extinguisher might not work when needed. Always follow approved instructions when checking fire extinguishers.
22. Have an adequate anchor and sufficient line (at least six times the depth of the water) to assure a secure hold in all types of weather and sea conditions.
23. Boat hooks are valuable when docking or when needed to retrieve objects that have fallen overboard.
24. Keep electrical equipment and wiring in good condition. Knife switches or other arcing devices should never be installed in fuel compartments. Allow ample ventilation around batteries.
25. Good housekeeping in your boat is important. Cleanliness diminishes the probability of fire.
26. Know your fuel tank capacity and cruising range. If it is necessary to carry additional fuel, do so only in

proper containers. Take special precautions to prevent the accumulation of fuel vapors in confined spaces.

27. Before departing on a boat trip, advise a responsible friend or relative about where you intend to cruise. Be sure to give that person a good description of your boat. Keep them advised of any changes in your cruise plans. These precautions will enable your friend or relative to tell the Coast Guard where to search for you and what type of boat to look for if you fail to return. Be sure to advise the same person when you complete your trip to prevent any false alarms about your safety.
28. Your local United States Coast Guard Auxiliary, the United States Power Squadrons, The Red Cross, and your state boating law enforcement agency offer safe boating classes several times a year. These are comprehensive courses, and are generally of minimal cost to you. Call your local U.S. Coast Guard Auxiliary, Power Squadron Flotilla, or your state agency for the time and place of their next class. Inquiries can be made to the Boating Safety Hotline, 1-800-368-5647 or to the Boat U.S. Foundation information number 1-800-336-BOAT.

Remember these are recommendations only. Check with the proper authorities for the exact safety requirements for your area.

## Trim

---

*Trim* refers to the way your Motoryacht floats in the water. When floating properly as designed, it is on an *Even Keel*. If it inclines to port or starboard, it *Lists*. If loaded too heavily forward, it *Trims By The Head* (or is *Down By The Bow*). If its draft is excessive aft, it *Trims By The Stern* (is *Down By The Stern*).

Your boat's trim can be affected by many variables such as optional equipment and loading of gear or cargo. Load gear and cargo as evenly as possible. If necessary, move heavy items to the opposite side or end to achieve proper trim.

## Other Tips

---

1. When commissioning a new boat, do not plan an extensive trip or outing until you have taken a shake-down cruise to make sure all equipment on your boat is functioning properly and you are familiar with its operation.
2. Use big fenders or fender boards to protect your yacht's hull whenever mooring next to floats, piers or other boats.
3. Carry plenty of line properly sized to your boat. We suggest at least four 60' lengths of 5/8" nylon line.

## Safety Equipment

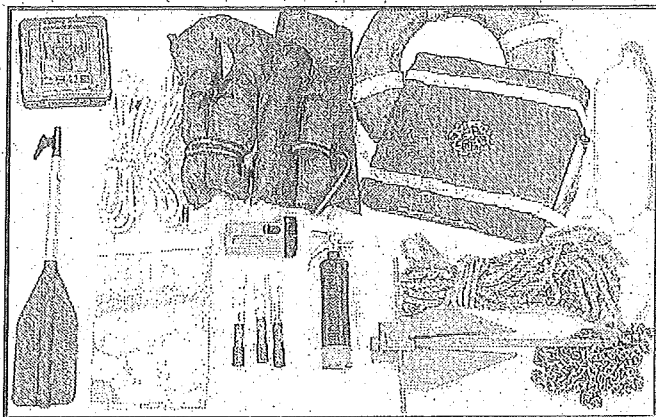

The following safety-related items should be considered as part of your standard equipment:

1. Fire extinguishers (correct number and type, located for easy access)
2. Personal flotation devices
3. Fenders, lines and boat hook
4. Flares (night and day type with unexpired dates)
5. Flashlight(s) with extra batteries
6. Charts of your intended cruising area
7. First aid kit
8. Anchor and adequate line

For information concerning the current requirements for safety equipment, Contact the local office of the United States Power Squadrons or the United States coast Guard Auxiliary.

## Tool Chest

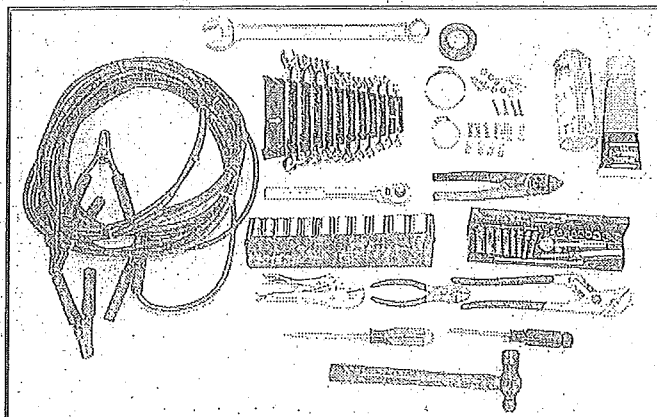

1. Assorted screwdrivers (Phillips and flat blade)
2. Pliers (regular, vice-grip, and water pump)
3. Wrenches (box, open-end, allen, and adjustable, include one wrench large enough to fit the prop nut)
4. Socket set (metric and U.S. standard)
5. Hacksaw with spare blades
6. Hammer
7. Battery jumper cables
8. Electrical tape
9. Assorted fasteners
10. Gear grease and penetrating oil
11. Feeler gauges

## Miscellaneous Items

1. Engine and accessories manual
2. Spare propeller with fastening hardware
3. Propeller shaft packing material
4. Spare propeller shaft and strut
5. Extra V-belts
6. Engine lubricating oil
7. Transmission fluid
8. Spare fuel and oil filters
9. An extra cooling pump impeller
10. Replacement light bulbs

## OPERATING

### Launching

1. Inspect the bottom of your new Motoryacht and make mental notes of the locations of all fittings below the waterline.
2. After the boat has been lowered into the water, immediately board it and inspect the lower compartments and around the thru-hull fittings for signs of leakage.
3. If any leaks are detected, immediately remove the boat from the water. The selling retailer should be notified so the leaks can be repaired before relaunching the boat.

### Fueling Procedures

#### **⚠ WARNING**

Fuel vapors are explosive and can become trapped in the lower portions of a boat where they might be ignited accidentally. While fueling your yacht, all doors, hatches, and portlights must be closed.

#### *To fuel your yacht:*

1. Be sure that your yacht is securely moored to the dock.
2. Turn off all electrical equipment, including engines, generator, appliances, bilge blower, lights, etc.
3. Extinguish all cigarettes, cigars or other items that may produce a spark or flame.
4. Close all openings including hatches, windows, doors and portlights.
5. Through-deck fittings for fuel tank filling are found on both the port and starboard sides of the cockpit and are labeled either GAS or DIESEL depending on engine option. Remove the cap and insert the diesel supply nozzle, allowing the nozzle to maintain contact with the fitting; this will prevent possible static sparking.
6. After about 10 gallons have been pumped into a tank, inspect the engine and tank area for signs of fuel leakage. Proceed with fueling if no problems are detected.
7. Often you won't be able to fill the fuel tanks to 100% of their dry-rated capacity. This is because the amount of fuel each tank will hold depends, in part, on the boat's floating attitude, which in turn affects the position of the fuel tank and its venting system. If fuel flows out the tank vent on the side of the boat,

discontinue fueling that tank immediately. The tank will be as full as possible under the current conditions. It is advisable not to overfill the tanks as you want to allow for thermal expansion of the fuel, especially on very hot days.

8. If, when filling the tanks, you can't put fuel in at a reasonable rate, check the fuel vent line for that tank to see that it's not kinked or plugged.
9. When you have finished fueling, replace the fill cap and wipe off any fuel spillage.
10. Open the engine compartment and all windows, doors, and hatches; inspect, both visually and by smell, for fuel fumes or leakage. Any sign of fuel leakage, or any indication of fumes, must be investigated and corrected prior to starting the engine.

Access to the fuel pick-up tubes and fuel senders for visual inspection and service is as follows:

Starboard through the salon sofa and the cut out through the floor and the bulkhead.

Port through the galley cabinet and the cut out in the floor.

11. Operate the bilge blower for at least four minutes prior to starting the engines. Leave the blower on until the boat is underway and up to cruising speed.

### Prestart Inspection

An operation and maintenance manual for your engines is included with your Motoryacht. Prior to initial operation we strongly recommend that you carefully read the contents of that manual.

Before starting the engines, check the following:

1. Fuel fumes.
2. Engine oil level.
3. Coolant level.

#### **⚠ WARNING**

To prevent severe burns or personal injury, DO NOT remove the heat exchanger caps while the engines or their cooling systems are hot.

4. Fuel level.
5. Transmission oil level.
6. Check that the fuel supply valves (and return valves on optional diesel engines) are open. The fuel management board is located on the forward bulkhead in the engine room.

Typical Fuel Management Board

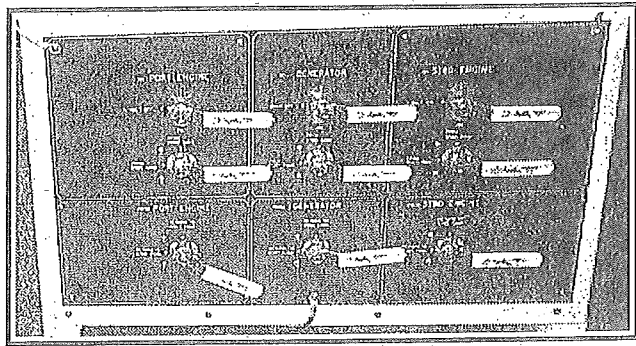

NOTE: Fuel Management Boards will vary according to engine type.

7. Check that the seawater intake valves (seacocks) are open.
8. Visually inspect the water separators for moisture or contamination (diesel engines only). If a large quantity of water is drained from this system, check secondary filters and fuel tanks for water. **DO NOT START THE ENGINES UNTIL ALL WATER IS REMOVED.**
9. Visually inspect the seawater strainers for debris.
10. Check all V-belts for correct tension.
11. Visually inspect for indications of fuel, oil and coolant leaks.

### Starting Procedure (Diesel Engines)

The Engine Operating and Maintenance Manual furnished with your engine, describes prestart and starting procedures in detail. We **strongly** recommend that you thoroughly read and understand the engine operation manual prior to starting the engines. The following procedures are intended as basic reminders only.

1. Turn the battery switch ON (located in the AC/DC cabinet on the starboard side of the salon).
2. Turn the engine room ventilation blowers ON. It is recommended that they are run for a minimum of four minutes prior to actual engine start.
3. Place the transmission selector lever in the NEUTRAL ("N") position.
4. Position the throttle control at the idle position.
5. Turn the DC ignition breaker switches ON.
6. The Engine Operating and Maintenance Manual furnished with your engine contains special instructions for low temperature starting (below 60°F [15.5°C]) or when starting after extended shutdown or oil change.

#### **⚠ WARNING**

Do not use ether or starting fluid as a starting aid as this may result in a fire or explosion.

7. Turn the ignition key clockwise to the "RUN" position. Before engaging the starter motor, wait 15 seconds (20 seconds if air temperature is below 32°F [0°C]) for the "Electrical Intake Air Manifold Heater System" to perform its preheat cycle. Turn the ignition key clockwise to start the port engine first. **DO NOT** continuously operate the starter for more than 30 seconds at a time.
8. If the engine does not start, wait at least two (2) minutes before making another attempt. If after two attempts the engine does not start, try to determine the cause before proceeding.
9. When the port engine starts, release the key. The key will automatically return to the running position. Start the starboard engine in the same manner.

#### **⚠ CAUTION**

Engine oil pressure must be indicated on the gauge within 15 seconds after starting.

#### **⚠ CAUTION**

Do not idle the engines for excessively long periods. Long periods of idling (more than 10 minutes) can cause damage to the engines.

10. Idle the engines for three (3) to five (5) minutes before operating with a load.

### Starting Procedure (Gas Engines)

#### **⚠ WARNING**

Gasoline vapors are highly explosive. To prevent a possible explosion and/or fire, check the engine room before each start for fumes or accumulation of fuel. Before starting the engines, operate the engine room ventilation blowers for a minimum of five minutes. Leave the blowers on during the starting process and anytime you are operating below cruising speeds.

The Engine Operating and Maintenance Manual furnished with your engine, describes new engine break-in, prestart and starting procedures in detail. We strongly recommend that you thoroughly read and understand the engine operation manual prior to starting the engines. The following engine start procedures are intended as basic reminders only.

1. Turn the battery switch ON (located in the AC/DC cabinet on the starboard side of the salon).
2. Turn the engine room ventilation blowers ON. It is recommended that they are run for a minimum of four minutes prior to actual engine start.



3. Place the transmission selector lever in the NEUTRAL ("N") position.
4. Position the throttle control slightly above the idle position.
5. Turn the DC ignition breaker switches ON.
6. If the engine does not start, wait at least 30 seconds before making another attempt. If after two attempts the engine does not start, try to determine the cause before proceeding.
7. A "low oil pressure" buzzer will activate when the key is turned on. If this warning does not cease within a few seconds after start-up, turn the engine off and investigate before a restart is attempted.
8. When the port engine starts, release the key. The key will automatically return to the running position. Start the starboard engine in the same manner.
9. Do not "race" the engines or allow either engine's RPM to exceed slow speed (1500 RPM) until they have warmed up.

### ⚠ WARNING

**Always pull the throttle lever back to SLOW before moving the shift lever to FORWARD or REVERSE. Failure to do so can cause transmission damage.**

## Engine Performance Changes

Most engine failures give an early warning. There can be any number of indications that service or repair is needed. Some changes to look for are as follows:

- Engine misfires
- Unusual vibrations
- Unusual noises
- Fuel, oil or coolant leaks
- Sudden changes in engine operating temperature or pressure
- Excessive smoke
- Loss of power
- An increase in oil consumption
- An increase in fuel consumption

## Carbon Monoxide (CO<sup>2</sup>)

### ⚠ DANGER

**Carbon monoxide (CO<sup>2</sup>) is a poisonous gas that is colorless, odorless and about the same weight as air. It will distribute itself throughout spaces of the boat in dangerous concentrations if proper ventilation is not provided. A person breathing these fumes will become seriously ill. Direct and prolonged exposure will cause brain damage or death. Opening windows or hatches may improve ventilation. Also, never operate the engine when either the slant cover or the camper cover is installed.**

Because CO<sup>2</sup> diffuses in the air much more rapidly than easily detectable gases you cannot rely on sight or smell to recognize its presence. CO<sup>2</sup> will be produced anytime materials containing carbon are burned. Common sources of CO<sup>2</sup> are internal combustion engines and open flame devices such as cooking ranges, space heaters, and charcoal grills.

The symptoms of CO<sup>2</sup> poisoning include but are not limited to the following:

1. Watering and itchy eyes
2. Flushed appearance
3. Inattentiveness and the inability to think clearly
4. Ringing in the ears
5. Tightness in the chest
6. Headache and/or throbbing temples
7. Drowsiness and fatigue
8. Incoherence
9. Nausea and/or vomiting
10. Dizziness
11. Collapse
12. Convulsions

If someone is suffering from CO<sup>2</sup> poisoning move the person to fresh air, administer oxygen if available, and contact medical help. If the victim is not breathing perform approved CPR procedures until medical help arrives and takes over.

To help prevent exposure to CO<sup>2</sup>, be aware of your ventilation and surroundings. Running your engine in a confined space such as a boathouse or next to a seawall can allow dangerous accumulations of CO<sup>2</sup>. Another boat with an engine running moored nearby can also expose you to dangerous amounts of CO<sup>2</sup>. Be sure that while underway there is a good flow of fresh air through the boat and that exhaust fumes are not being pulled up into the boat by "backdrafting". Backdrafting will be greater whenever canvas is installed or if you run in a bow-up trim angle.

## **WARNING**

Gasoline portable generator sets produce CO<sup>2</sup>. These units discharge their exhaust where they are located which can lead to the accumulation of CO<sup>2</sup> in the area. This equipment should *NEVER* be used on recreational vessels.

### Before You Leave

Before you leave the dock, perform the following steps in addition to the instructions listed under "Starting Procedures":

1. Check fluid levels in the generator.
2. Check the operation of the more essential equipment such as bilge pumps, running lights, wipers, water system, radios, navigation aids, etc.
3. Instruct passengers in the use and location of flotation devices and fire extinguishers.
4. Fill the fresh water tanks.
5. Obtain a reliable weather forecast and plan accordingly for everyone's comfort and safety.
6. Notify a responsible friend or relative of your cruise plans. Upon your return or a change in your cruise schedule, notify that person again in order to avoid unnecessary concern.

### Maneuvering

When all of your predeparture checks have been completed, you will be ready to leave the dock.

### Basic Maneuvering

Steering your yacht at either idling or cruising speeds will generally require minimal effort. Practicing maneuvers at slow speeds will help you to become familiar with all the special handling characteristics associated with your boat.

Remember that all boats steer by the stern (the feeling is much like steering your automobile in reverse). This means that the stern of your boat will swing in the direction opposite to your turn. For example, when you turn the helm wheel to port, the stern of the boat will swing to starboard as the boat goes into a port turn. This is especially important to keep in mind when docking and when operating in close quarters with other boats.

Your boat has twin propellers, so you can engage one engine in forward gear and the other in reverse gear to turn the boat completely around in its own length. Usually the rudders are left in the centered position. You can make such a turn in either direction. Port engine forward and

starboard engine in reverse spins you clockwise. Starboard engine forward and port engine in reverse spins you counterclockwise. You usually can increase the rate of spin by turning the rudders in the direction of the spin.

Always use extreme caution when approaching someone in the water. Approach them from the leeward side at idle speed only, allowing your stern to swing away from them as you get close. Place the shifter in NEUTRAL and shut off the boat's engines when you are still several feet from the person in the water. While they are swimming over to the boat, lower the swim ladder from the transom platform so they can board. Once everyone is aboard, return the swim ladder to its stowed position and check that everyone is safely seated before restarting the engines. If you are unfamiliar with picking up swimmers in the water, practice this maneuver with a retrievable floating object before attempting it under actual condition.

Boats do not have brakes. Stopping is accomplished by backing down on the throttles. Once the boat has slowed and the engines are idling, you can place the shifters in REVERSE. Gradually increasing reverse power with the throttles will allow you to stop the boat in a very short distance. Note that a boat will not respond to steering in reverse nearly as well as it does when going forward, so do not expect to accomplish tight turning maneuvers when backing up.

Once you are away from the dock, devote some time to learning how to maneuver.

- Practice docking by using an imaginary dock.
- Practice stopping and reversing.
- When operating in close quarters or docking, all maneuvering should be done at idle speed.
- Proceed with caution in congested areas.
- Gradually increase your speed. Get used to the boat before attempting any full throttle operation.

### Docking

#### *Preparation:*

Proper docking requires practice and preparation. Start by making sure you have adequate mooring gear, and that it is stowed correctly and is ready for use. Your dealer is the best source for information concerning the amount and type of equipment you should carry.

#### *Approaching the Dock:*

When approaching a mooring area, lower your speed within a reasonable distance to allow your wake to subside before it reaches other boats or docks. As you get close to your moorage, check for any wind or current action that may affect your maneuver; then make a conservative approach with these factors in mind. Try to use the elements to your advantage. Allow them to carry the boat to the dock. If there are high winds or strong currents, it is

best to approach the moorage from the lee side. While approaching, check to see that all lines are attached to the cleats on the side facing the moorage. Also insure that fenders are lowered on that side. Be sure to check that the fenders are hung at the proper height.

As you approach your moorage, it is desirable to have one person at the bow and one at the stern of the boat, each with a boat hook and a mooring line attached to a cleat. Approach at idle RPM at an angle approximately 45 degrees to the dock. When the bow is within a few feet of the dock (starboard side), the stern can be brought alongside the moorage by reversing the port engine and leaving the rudders amidships. These steps are reversed for docking to port.

### WARNING

Whenever docking all crewmembers and passengers should remain in the boat until maneuvering is complete. Do not attempt to dock with anyone standing on the transom platform. Also do not attempt to fend the boat away from objects being approached with your body including hands and feet.

#### Mooring:

To attach lines to deck cleats, make a loop in one end of the line and pass it through the hole in the base of cleat; then pass the loop back over the entire cleat. The line can now be used to secure your boat. Lines may be kept this way while underway as long as they are coiled and cannot become fouled in deck gear or props. In heavy sea conditions, all lines should be removed from the decks.

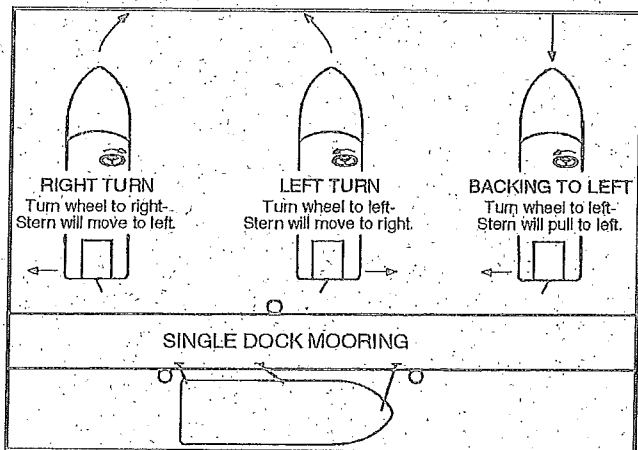

#### Leaving the Dock:

Take into account wind, tide, current and other forces that affect your maneuvering. Most maneuvering to and from a dock is best accomplished at idle speeds. Do not forget to release mooring lines, unhook shore power cords, and stow fenders.

## Towing

If it becomes necessary to have your boat towed, attach the towline to the bow eye (if so equipped). If your boat is not equipped with a bow eye, the Coast Guard or other professional assistance should be sought to properly rig a tow bridle. Deck hardware should never be used for towing.

### WARNING

Never attach a towline to deck cleats or to the anchor windlass. Serious injury may result if the cleats or windlass pull free from the deck.

More thorough information is available through the U.S. Coast Guard Auxiliary or U.S. Power Squadrons.

## Boat Performance

Boat speeds are affected by a great many factors. Some, such as temperature and altitude, you cannot change, but some factors you can:

1. Loading: Take only necessary equipment with you. Keep weight low in the boat and balanced.
2. Propellers: Keep them in good repair and at the correct pitch for your particular situation. The factory standard propellers may not be the best for your particular boat and load conditions. Check your Engine Operation and Maintenance Manual for the correct full throttle RPM rating (normally loaded boat). If your engine RPM at full throttle does not meet these ratings ask your Bayliner Motoryacht Dealer about trying different propellers.  
A slightly bent or nicked propeller will adversely affect the performance of your boat.
3. Keep your yacht's bottom clean of weeds, barnacles and other growth. When your yacht's hull starts "growing grass", it will slow down greatly.

## Boat Running Trim

1. If your boat runs with its bow too high at cruising speeds, move weight forward in the boat or adjust the trim tabs (see trim tab section below).
2. If your boat runs with its bow too low at cruising speeds (usually indicated by steering difficulty), you can raise the bow by moving weight aft or adjusting the trim tabs (see trim tabs next page).

## Trim Tabs

Trim tabs control the longitudinal and lateral trim of your boat at cruising speeds. Two rocker switches, identified by the words BOW DOWN, are located at each helm station.

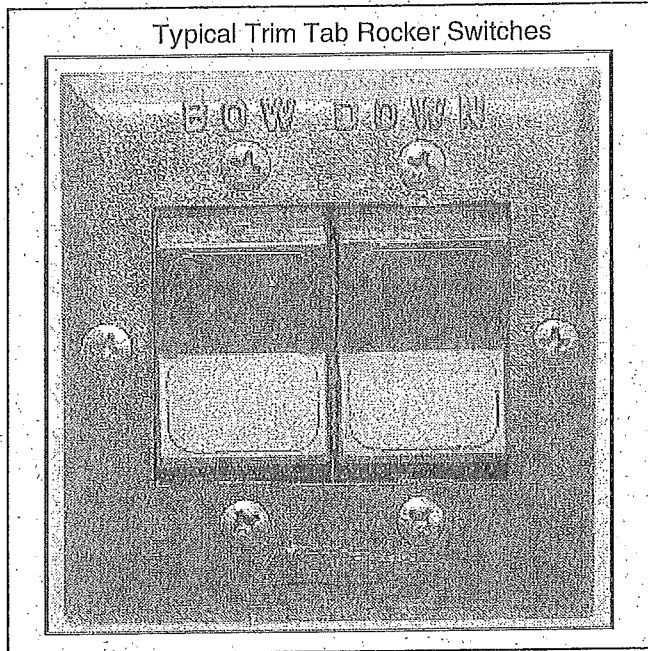

Once the best bow cruising attitude is achieved, activate the port or starboard trim switches individually to correct for unequal lateral loading. Do not use trim tabs to compensate for excessive unequal weight distribution.

Trim tab adjustment should be performed by several short touches of the trim button, rather than one long one. Allow approximately five seconds for the hull to react between each switch activation.

The trim tab hydraulic fluid reservoir is located on the port side of the transom. The fluid level should be checked periodically (at least once per year) and refilled as necessary.

### **⚠ WARNING**

**Improper use of trim tabs will cause a loss of control. Do not use trim tabs in a following sea, as they may cause broaching or other unsafe handling characteristics. Do not allow people who are unfamiliar with trim tabs to operate them.**

## Instruments

While under way, instruments should be checked frequently for possible indications of trouble. All the instruments listed below are located at both helm stations.

1. *Tachometer*—Indicates engine revolutions per minute (RPM). The tachometer is useful for monitoring engine speed to avoid exceeding the maximum RPM rating.
2. *Temperature Gauge*—Indicates engine coolant temperature by monitoring a signal from a sending unit installed in the engine water jacket. When the gauge reads in the danger area, shut off the engine and diagnose the problem. A common cause of overheating is picking up a foreign object in the seawater intake. Clearing the intake or seawater strainer will usually rectify this problem.
3. *Oil Pressure Gauge*—Indicates engine lubricating oil pressure. Low pressure readings are generally caused by low oil quantity. In any case, immediately shut down the engine and diagnose the problem.
4. *Fuel Gauge*—Indicates the approximate fuel level. Since boats are exposed to rough water conditions and varying degrees of trim, it will not always be possible to fill the tank to 100% of its dry-rated capacity. Therefore, fuel gauges may seem to provide inaccurate readings at times. It is always good to keep track of the amount of fuel you pump aboard, as well as your running time and estimated fuel usage as a double check against an inaccurate gauge.
5. *Compass*—Before using your compass for marine navigation, you must have it professionally swung. Many factors affect the operation of your compass, such as local magnetic variation and deviation (induced needle deflection caused by metal components, the operation of electrical equipment aboard your boat, and items containing ferrous metals i.e. binoculars that may be set near the compass). Your Bayliner dealer can refer you to local shops that perform this work.

## Grounding

### **⚠ WARNING**

It is the skipper's obligation to know, understand and follow all navigational markers. Be aware of depth charts at all times. No vessel is built for, nor can it sustain without damage, a grounding. If a grounding occurs, call for assistance immediately. *Before* removing the vessel, inspect the vessel thoroughly for holes or fiberglass cracking, fracturing or delamination. Make necessary emergency repairs before proceeding.

Running aground is often merely inconvenient but in extreme situations it may also be dangerous. As in any emergency situation the most important thing to do is remain calm, don't panic. If you find yourself aground resist the temptation to immediately put the engine in

reverse and gun the engine in an attempt to back off. If the boat has grounded in mud or sand this may only cause the prop to blow more mud or sand under the boat making it even more firmly grounded. In addition, it may also pull the mud or sand into the engine water intake and up into the engine itself. Following are some brief explanations of possible actions to take in event of grounding. More thorough information is available through the U.S. Coast Guard Auxilliary or U.S. Power Squadrons.

1. Shift to NEUTRAL
2. Immediately switch on the bilge pumps and check the hull to see whether it has been punctured and is taking on water (if not taking on water turn the bilge pumps off). A hand operated bilge pump is a good safety item to have aboard in case the electric pumps cannot remove the water fast enough. If it becomes absolutely necessary, the engine's cooling pump can be brought to use. Shut down the engine and shut off the seacock. Disconnect the water hose from the seacock and fit the end with a filter screen. Put the end of the hose into the water in the bilge and restart the engine. Check frequently that the engine cooling system has a continuous supply of water. Canvas, cushions, or even bedding can be used as temporary patches to the outside of a stove in hull, hold them in place with docking lines. If taking on water rapidly it may be better to leave the boat grounded. She may sink if moved to deeper water. Make a "PAN-PAN" (pronounced Pawn-pawn) distress call on channel 16 on the VHF radio, use the "MAYDAY" distress signal **only** if you or your boat are in grave and immediate danger.
3. If in tidal waters check the status of the tide. If coming in, it may lift the boat enough to get you free. Wakes from passing boats will also help lift you off. If the tide is falling take as many soundings as possible to determine the direction of deepest water. Then fasten the anchor line to the stern cleats, put the anchor and line in the dinghy and row the anchor out to deeper water paying out line from the dinghy. Pay attention to wind and current and set the anchor up wind or current from the boat (this is called *kedging*). Pull the boat from the grounding by pulling the anchor line and alternating with moderate reverse engine power if necessary. A "block and tackle" or "come-along" will greatly increase your pulling power and are good items to have aboard. If you need assistance make a "PAN-PAN" distress call as stated above.

## Dual Station Operation

Start the engines at the station from which you will be operating the boat. Remind everyone near the unattended control station to KEEP HANDS OFF. When leaving one station to begin operating at the other, bring the boat to a complete stop. Never leave the helm while the boat is

underway and assume that someone else has the boat under control. If you are operating your boat from the bridge and you encounter heavy sea conditions, bring the engines down to idle, point the boat into the sea and have bridge passengers move down to the cabin. If sea conditions become very heavy, you should also leave the bridge and operate your boat from the lower station. Children should be required to wear life jackets.

## Structural Limitations

Cabin tops and flying bridges are designed to be lightweight for proper boat balance. The cabin top and flying bridge load limit for your yacht is 1000 pounds. The transom platform is designed to accept a maximum 400 pound load, and the bow anchor platform will accept a maximum 250 pound load.

## Engine Shut-Down

1. Cool the engines down gradually, allowing them to idle in neutral for at least five minutes.

### NOTICE

**Gradual cool-down of turbocharged engines is absolutely necessary to avoid shortened turbocharger life.**

### CAUTION

**Follow steps 2, 3, 4, and 5 in sequence to avoid the possibility of electrical system damage.**

2. To turn the engines off, turn the ignition keys counter-clockwise to the OFF position.
4. Turn the DC ignition breaker switches to the OFF position.
5. Turn the battery switch OFF.

### NOTICE

**Steps 6, 7, and 8 need not be followed for short term shut-down (overnight). For longer term storage refer to the storage section of this manual.**

6. Close the seawater intake valves (seacocks).
7. Close the fuel supply and return valves.
8. Carefully inspect the engine and engine compartment for indications of oil, fuel, water, or exhaust leakage.

## COMPONENTS/SYSTEMS

The following are highlights of some of your yacht's onboard systems and components. Additional details are included in literature supplied with your yacht.

### **⚠ DANGER**

Knife switches or other arcing devices should **NEVER** be installed in fuel compartments.

### **⚠ DANGER**

**NEVER** substitute automotive parts for marine parts. Electrical, ignition and fuel system parts on your Motoryacht are designed and manufactured to comply with U.S. Coast Guard Rules and Regulations to minimize risks of fire and explosion.

### **⚠ WARNING**

Only qualified personnel should install batteries and perform electrical system maintenance. You can minimize the danger of fire and explosion by not exposing the batteries to open flame or sparks. It is also important that no one smoke anywhere near the batteries. Because fuel fumes are heavier than air, they will collect in the bilge areas where they can be accidentally ignited. Running the bilge blowers for at least four minutes prior to engine starting, electrical system maintenance, or activation of electrical devices will decrease the danger of fire and explosion. Also, insure that all battery switches are in the OFF position before performing any work in the engine spaces.

### **NOTICE**

Electrical connections are susceptible to corrosion. To help prevent electrical malfunction due to corrosion, keep all exposed electrical connections clean and protect them with a good quality spray-on protectant, such as Corrosion Guard®.

## Electrical System (12-Volt DC)

Electrical system diagrams are provided in the back of this manual for use in troubleshooting electrical problems.

The fuses and circuit breakers for main accessory power, float switches and windlass power are located in the AC/DC cabinet on the stbd side of the salon. The rotary battery switches are located in a cabinet under the shift throttle levers at the lower helm station (see

photo on page 16). Separate switches are provided for all three batteries. In addition, a crossover switch is provided to enable you to start the engines using the accessory battery in the event that engine battery power is low. The crossover switch also allows you to operate accessories off the engine battery. **The crossover switch is to be used only as a temporary remedy and should be turned off after use.**

### **⚠ CAUTION**

The crossover switch should be turned on only in emergencies. Leaving this switch ON can drain all batteries. Also, you should never disconnect battery cables or turn the main battery switches to the OFF position while the engines are running, as this can cause damage to your boat's electrical components.

Battery condition can be easily checked on the "Electrical System Monitor" located on the DC Main Distribution Panel. Note that the condition of the accessory battery can be read on the starboard engine voltmeter whenever the accessory battery switch is in the ON position. The starboard ignition switch *does not* have to be on to read the accessory battery condition. That means the starboard voltmeter will register the accessory battery state even when the engines are shut down and ignition switches are turned off.

The batteries supply you with electricity for lights, engine and generator starting, and power to run the accessories. **Periodically remove the battery caps and check the electrolyte level.** If the zinc plates are exposed, add distilled water until they are covered again. Corroded battery terminals can be cleaned with baking soda and water. Then coat them with a preservative or a light film of grease. Be sure all battery connections are tight.

The engine alternators will maintain proper charge levels in the house battery and both engine batteries (some situations may require running engines at 1200 RPM to initiate charging). The port engine starts and runs off the port battery. The starboard engine starts and runs off the starboard battery. A charging circuit isolator on the starboard engine allows both the house battery and the starboard battery to be charged by the starboard engine alternator.

In addition to the engine alternators, the 4087 Motoryacht is equipped with a battery charger. The battery charger is located in the forward bilge compartment on the starboard side. The battery charger will charge all three batteries whenever the boat is plugged into 110-volt shore power or whenever the generator is operated. The circuit breaker for the battery charger (located on the main AC power panel) must be in the ON position for charging to occur.

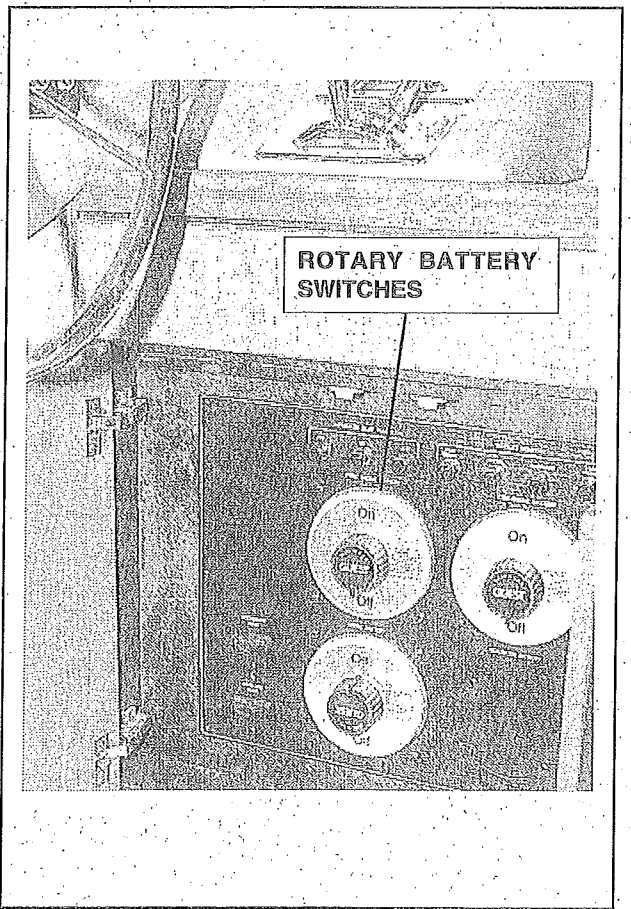
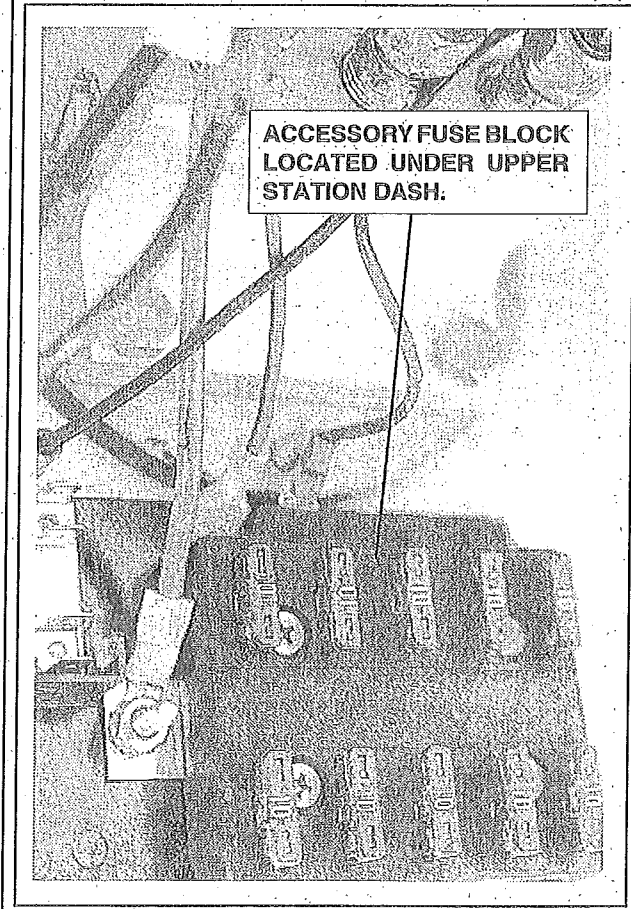
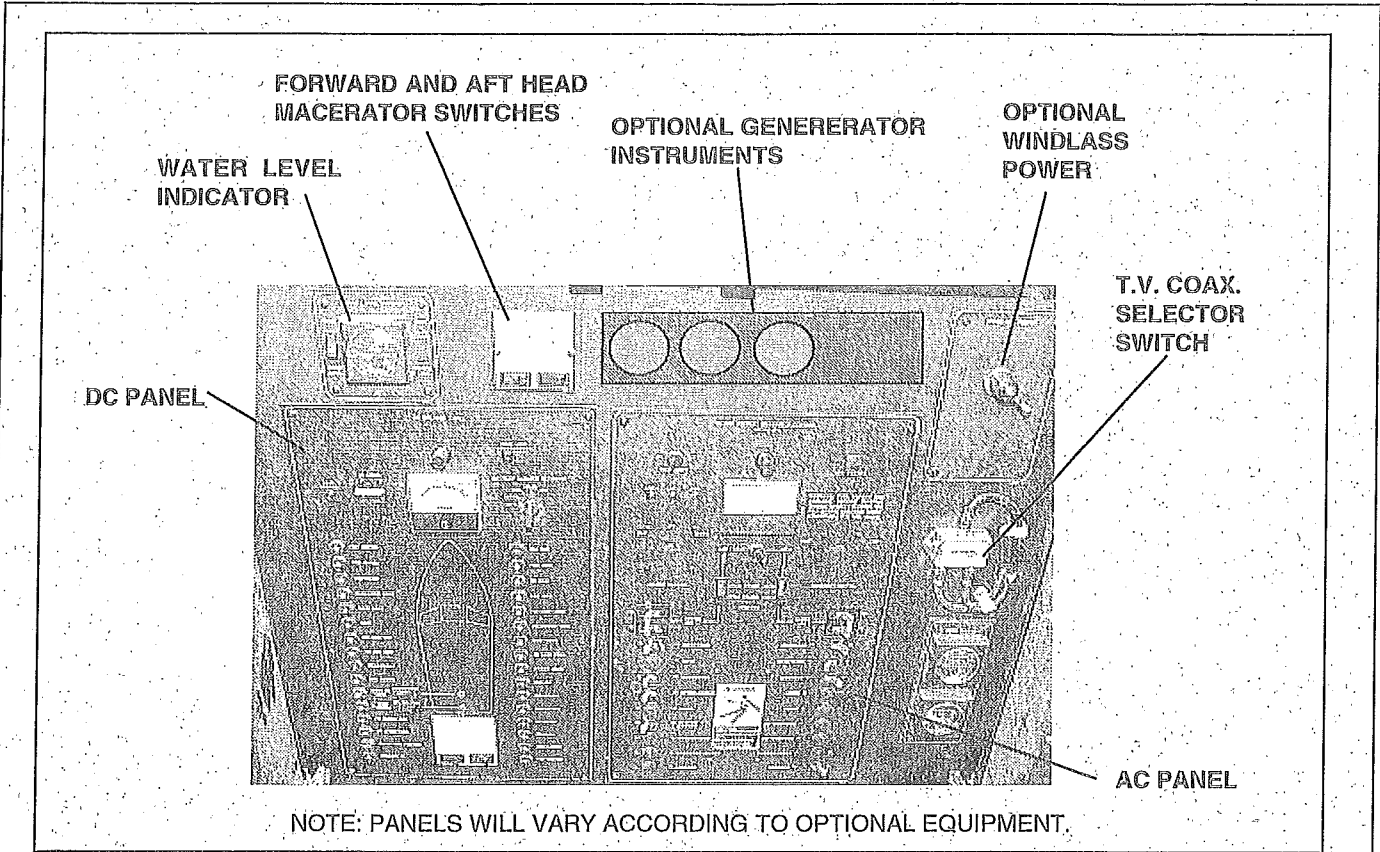

## ⚠ CAUTION

The battery charging systems (alternator and battery charger) installed are designed to charge conventional lead-acid batteries. Before installing gel-cell or other new technology batteries, consult with the battery manufacturer about charging system requirements.

Circuit breakers for all engine and accessory circuits are located on the DC main distribution panel located on the starboard side of the salon. Electronics power is provided at the upper helm station. Some equipment, such as depth sounders and shower pumps, may have secondary fuse protection located at the unit.

## Electrical System (110-Volt AC)

The AC system is energized by either shore power or the onboard generator. Master circuit breakers, located on the AC panel, provide power source selection. This system is designed so that ship's power and shore power sources cannot supply power simultaneously.

Two shore power receptacles are found outside the cabin on the starboard side. Shore power receptacles are rated at either 30- or 50-amps and appropriate power cords are furnished. Since not every shore installation has 30-amp service, we recommend that 15- and 20-amp adapters be purchased. However, whenever 15- or 20-amp adapters are used, there will be a corresponding drop in supplied power from the dockside system. **Note that you should never hook dockside power to your boat overseas unless you purchased the overseas option, which is rated for 220 volt/50 Hz., whereas standard domestic systems are rated for 110 volt/60 Hz. power.**

## ⚠ WARNING

Monitor the electrical control panel's polarity indicators when connecting shore power to your boat. A green light illuminating after the power cord is plugged into the boat's external power receptacle indicates acceptable electrical power. Therefore, you may energize the main breaker switches. However, a red light indicates *reversed polarity*, which could cause electrical system damage and possible electrical shock injuries. In this case, **DO NOT** energize the main breaker switches. Instead, immediately disconnect the shore power cord (always from the dockside outlet first) and notify marina management.

## Shore Power:

Before connecting to shore power, ensure all breakers and switches on the AC Master Panel are in the OFF position. Always attach the shore power cord to the boat inlet first; then to the dock connection, thereby avoiding accidental dropping of the "Hot" cord into the water. Correspondingly, remove the dock connection before removing the cord from the boat.

When using shore power to each individual inlet, check for proper polarity as outlined above. Activate the AC system by switching the dockside master breakers. Then turn on each individual Component Breaker as required.

Voltage on each line can be read by setting the Voltmeter Selector Switch.

## Generator Power: (optional)

Follow the information outlined in the Generator section of this manual and in the literature package supplied with your generator for prestart checks and starting procedures. Polarity has been established in the installation of the generator, therefore the polarity lights will not function in this mode.

Activate the AC system under generator power by switching the generator master Breakers (1). Turn on each individual component breaker as required.

Oil pressure, water temperature, and volt gauges are adjacent to this panel and monitor the engine functions of your generator.

Whether using shore power or the generator, the simultaneous operation of several AC components can result in an overloaded circuit. It may be necessary to turn off one or more accessories in order to operate another accessory.

AC electrical system diagrams are provided in the back of this manual

## Optional Generator

The literature package supplied with your boat has a very complete operator's manual for your generator. We urge you to read that manual prior to initially operating your generator. The following are some highlights concerning this unit.

## ⚠ WARNING

Fuel vapors can explode. Before starting generator (or propulsion engines):

- Check the generator, engine and fuel compartments for gasoline or vapors.
- Operate the bilge blower for four minutes (Continue blower usage if operating the boat below cruising speeds).



1. Follow instructions in the operator's manual for pre-start checks and break-in procedures.
2. Circuit breakers for all engine and accessory circuits are located on the DC main distribution panel on the starboard side of the salon. Electronics power is provided at the upper helm station. Some equipment, such as depth sounders and shower pumps, may have secondary fuse protection located at the unit. Starting switches, gauges and the generator battery switch are located on the AC electrical panel on the starboard side of the salon.
3. Always operate the bilge blower for a minimum of four minutes before starting the generator. Leave the blower running while the generator is operating unless running the boat at cruising speed.
4. If your generator has a diesel engine, turn the preheat switch to the "on" position and allow one minute for preheating.
5. Never operate the starter for more than 30 seconds. If the generator does not start, wait at least 30 seconds before another starting attempt is made.
6. Fuel to run the generator is supplied from either the port or starboard fuel tanks. **If your generator has a diesel engine, you should set the fuel selector valves so that return fuel is routed back to the same tank from which it was drawn.** Otherwise, in cases where generator fuel is drawn from a nearly empty tank and returned to a full tank, **it is possible to accidentally spill fuel overboard through the tank venting system.**
7. In addition to servicing the filters attached to the (diesel) generator, the filter/separator located near the fuel line valves should be serviced as described in the instructions included with your literature package.
8. The coolant mixture installed at the factory consists of equal parts of water and antifreeze (Ethylene Glycol).
9. The seawater intake valve must always be open during generator operation, and the seawater strainer should be frequently checked for debris.
10. Approximate normal gauge readings during generator operation are: temperature = 165° to 195° F; oil pressure = 35-55 PSI.

## Water Heater

The water heater is located on the stbd side of the engine compartment, forward of the engine.

The heater must be kept full of water to avoid damage to the 110-volt heating element, and should be drained when the possibility of freezing exists (power turned OFF).

There is a heat exchanger system connected to the port engine; hoses related to this system should be checked frequently for condition and leakage.

## ⚠ WARNING

Water heated by the heat exchanger system can reach temperatures high enough to scald the skin. Use care when using the hot water after running the port engine for any period of time.

## Air Conditioning/Heating (Optional)

Both heating and cooling are controlled from the same panel. Refer to the Environmental Control Unit booklet supplied in your information packet for detailed instructions concerning proper operation of the heating and air conditioning systems.

## Anchor Winch (Optional)

The literature package includes instructions for the anchor winch. To haul the anchor, move the boat towards the anchorage using engine power until directly above it. Then activate the winch to disengage the anchor from the bottom by pulling it straight up. Do not pull the boat to the anchor using the winch or continue to operate the winch if it has stalled or overloaded.

**VIEW OF ENGINE ROOM FROM AFT STATE ROOM LOOKING FORWARD**

**FUEL MANAGEMENT BOARD**

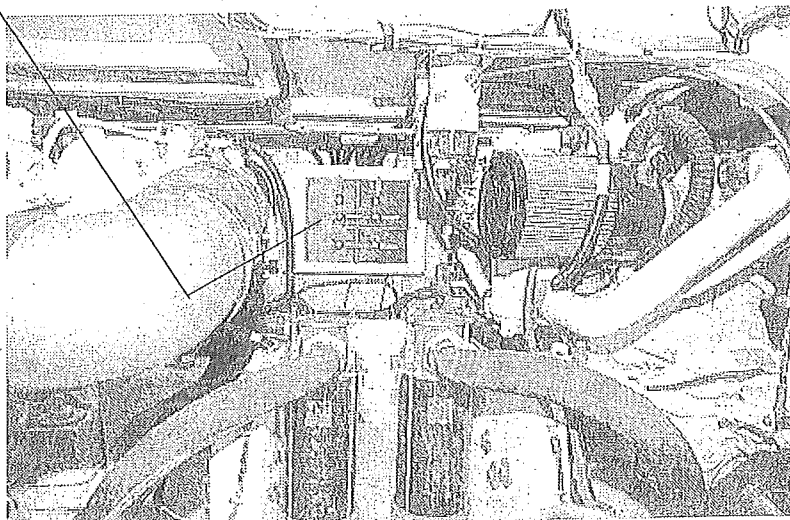

**ACCESS TO ENGINE ROOM THROUGH FORWARD BULKHEAD IN AFT STATE ROOM**

## **Fuel System**

See the FUEL SYSTEM drawings on pages 26 and 27 for a basic description of this system.

Using the supply valves, fuel can be directed from either tank to the engines and generator as desired.

Filters (and separators, if diesel) should be inspected and maintained as detailed in your engine manual, generator manual, and in the filter literature supplied with your boat.

Make sure that your fuel suppliers are reputable and can be relied upon to furnish clean, high quality fuel. Once you have found such suppliers, keep your tanks as full as possible with their fuel, allowing for expansion due to temperature variation. Then, if you are forced to add to the tank with a potentially poor quality supply, the portion of poor quality fuel will be minimized.

Refer to your engine manual for fuel grade recommendations.

Ask your dealer or local marina about fuel additives that help to prevent fungus growth in your fuel tanks.

If you have diesel engines, you must not allow air in your fuel lines. Bleed air from your fuel system after any fuel system maintenance. Refer to your engine manual for detailed instructions on "bleeding".

## Shaft-Transmission Alignment

Alignment between your engine transmission output shaft and the propeller shaft is very critical. Although this alignment has been performed at the factory, it should be checked again after the boat has been in the water for 48 hours. Alignment inspection should be part of the routine maintenance program (after the initial 30 hours of operation, then every 60 hours) and whenever unusual noise or vibration is noticed. When launching after a haul-out or dry storage, ensure proper alignment by waiting 48 hours before making final adjustments.

Although actual alignment should be performed by an experienced marine mechanic, checking the alignment is relatively simple when these procedures are followed:

1. Remove the flange bolts at the transmission-to-shaft coupling and slide the shaft aft until the flanges are about 1/4" apart.
2. Check for obvious flange "wobble" by rotating the shaft. Wobble indicates probable shaft damage.
3. Move the shaft up and down and side to side to determine, as closely as possible, the normal, central shaft position. At this position, the transmission and shaft flanges should align without moving the shaft more than 1/8" in any direction. If this is not the case, a misalignment condition exists.
4. Move the shaft flange into contact with the transmission flange. Check the gap between flange faces by attempting to insert a .003" feeler gauge at the top, bottom and each side. Repeat this operation after rotating the shaft flange 1/4 turn (3 times). Misalignment is indicated when the feeler gauge can be inserted easily at any point.

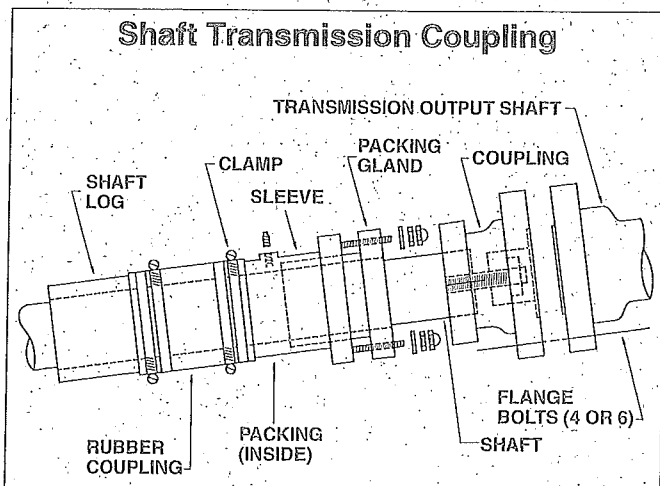

## Shaft Log Stuffing Box Packing

The propeller shaft emerges from the bottom of the boat through an opening called the shaft log. The shaft stuffing box is connected to the shaft log by a short length

of special flexible hose. Packing rings are compressed around the shaft by the packing gland. The stuffing box prevents excessive amounts of water from leaking around the shaft and into the boat. Normal wear can cause stuffing box leakage to increase. It usually can be stopped by tightening the packing gland nuts slightly. Do not over-tighten the packing gland nuts. Bear in mind that a slight leak (up to 10 drops per minute while running) helps to lubricate the packing and is therefore necessary.

When stuffing box leakage becomes excessive, even after following the above steps, packing replacement can be performed as follows:

1. Remove the boat from the water.
2. Loosen the packing gland nuts and back the packing gland from the sleeve. Remove the old packing.
3. Wrap new packings around the shaft (4 rings, 3/16" for 1 3/4" & 2" shafts), then cut the rings with a razor blade at an angle approximately 30 degrees to the long axis of the shaft. Stagger the ends of each ring around the shaft and insure that the rings bottom in the sleeve.
4. Tighten the packing gland nuts until resistance is felt.
5. When initially launched, the packing must be allowed to leak at a rate of 5 to 30 drops per minute, as it will expand and seal from water contact and friction heat from the turning shaft. Failure to allow this leakoff will result in packing burnout after a short period of time.

## Rudder Stuffing Gland

As in the case of the shaft log stuffing box, the rudder stuffing gland is part of the assembly where the rudders emerge from the bottom of the boat.

It is very similar to the propeller shaft stuffing box and will require the same maintenance. Since it does not receive the same wear as the propeller shaft, repacking is seldom required. This shaft stuffing gland should not leak water.

## Stove

Your Motoryacht is equipped with a liquid propane gas (LPG) three burner stove/oven. Before attempting to operate the LPG stove/oven, read the operating instructions in the boat's literature package.

**! DANGER**

LPG is heavier than air and if allowed to settle, accumulate and if ignited, WILL CAUSE AN EXPLOSION!

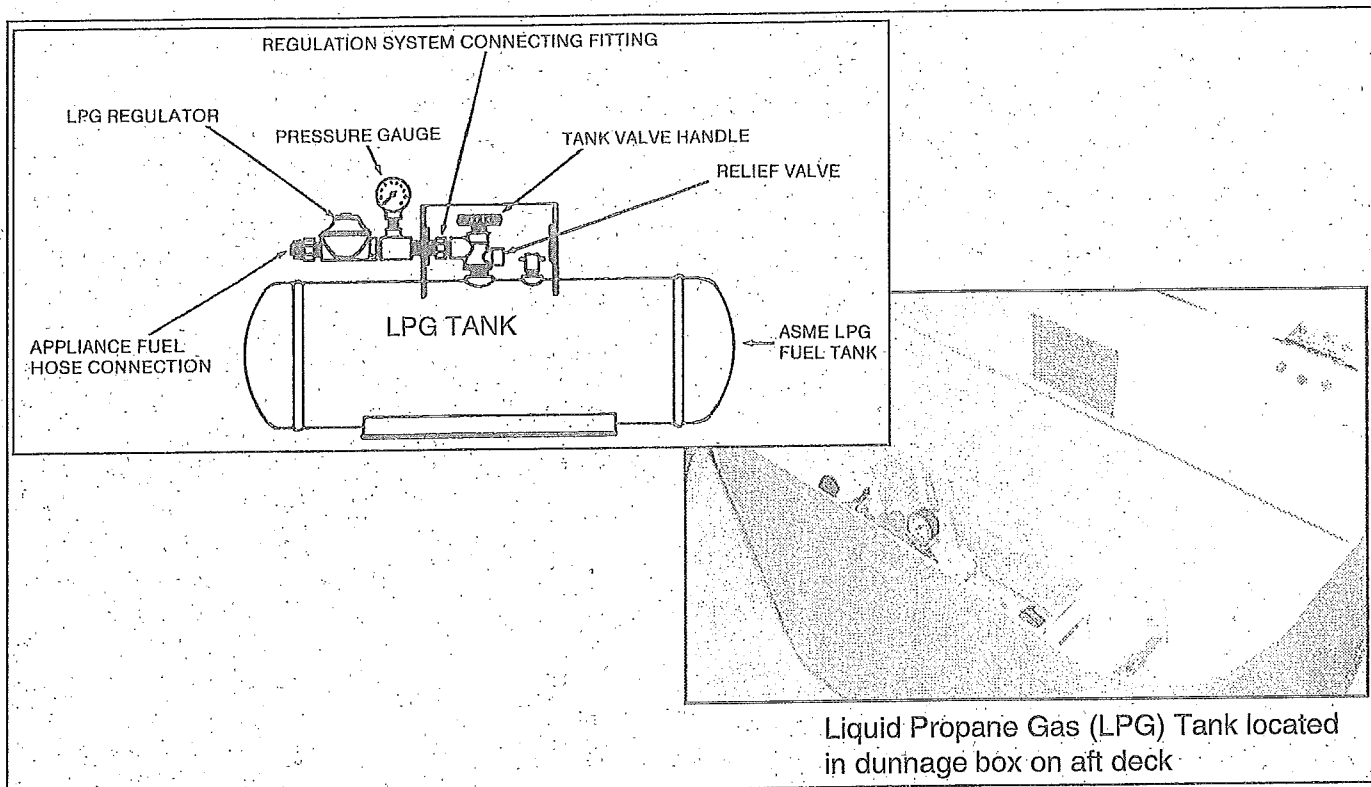

**⚠ WARNING**

Do not touch burners, grates or areas near units (units may be hot even when they are dark in color). Areas near burners and grates may become hot enough to cause burns. During and after use; do not touch or let clothing or other flammable material contact units or areas near units until they have had sufficient time to cool. Among these areas are; burner top, main frame sides and back, searails and potholders.

LPG system operation summary:

1. Close tank valve immediately in any emergency.
2. Be sure all appliance valves are closed before opening tank valve.
3. Always apply lit match or other flame to burner before opening burner valve.
4. Close tank valve whenever appliance is not in use.
5. Test system for leakage at least twice a month in accordance with the following procedure:
  - With appliance valves closed and with tank valve open, note pressure on the gauge.
  - Close cylinder valve. If the pressure reading on the gauge drops, THERE IS A LEAK IN THE SYSTEM.
  - Locate leakage by application of liquid detergent or soap and water solution to all connections.

- NEVER USE FLAME TO CHECK FOR LEAKS!
- After leak has been repaired, RECHECK SYSTEM BEFORE USING APPLIANCES.

**⚠ CAUTION**

Do not use detergents and soaps containing ammonia. Ammonia will attack the brass LPG fittings and may cause cracks or leaks.

6. Always have an approved ABC type fire extinguisher in the galley area.

### Microwave Oven

All 4087 Motoryachts are equipped with a microwave oven. Before attempting to operate the microwave oven, make sure the breaker switch on the AC Master Panel is ON. Operating instructions for the microwave oven can be found in the boat's literature package.

### Steering

Your steering system is manual hydraulic, not power steering. This system will not turn as easily as a car's power steering.

A rhythmic pulsing when turning the wheel is a characteristic of the pump and is not a malfunction. When coming off a hardover position, resistance may be felt,

followed by a distinct sound. This is a normal situation resulting from the release of the check valve.

The fluid reservoir for the hydraulic steering system is located in the aft end of the engine compartment. Following instructions in your literature package and on the reservoir, check the fluid level and pressure regularly.

### Spotlight (Optional)

The spotlight can be controlled from the bridge helm station. The spotlight is located on the bow platform.

### Refrigerator

The refrigerator used in your 4087 Motoryacht operates on 110-volt AC and 12-volt DC power. When the 110-volt system is not operating, the refrigerator operates on 12 volts. When an AC source is supplied by a generator or dockside power, the refrigerator automatically switches over to the 110-volt power supply.

The refrigerator is the heaviest continuous draw on the 12-volt DC system. If no other 12-volt accessories are used, the refrigerator can draw a 100 amp battery dead in less than 24 hours. For this reason it is recommended that when operating on 12 volts, the cold setting on the refrigerator should not be set higher than position TWO. It is also advisable to turn the refrigerator off at night. If you are going to be out more than one day and cannot connect to dockside power, you should plan to run your generator or engines to maintain a charged battery.

### Seawater Strainers

Seawater strainers should be periodically checked for debris. The standard configuration is one strainer for each engine, one for the generator, and one for the air conditioning system (if installed). The strainers are located in the engine compartment.

### Exhaust System

The yacht exhaust system is designed to keep water out of the engines in most sea conditions. However, do not anchor stern to sea, and do not shut off the engines if the seas are too high. Always consider the sea condition before anchoring or shutting off the engines.

Check all exhaust system clamps after the first 20 hours. Check the clamps periodically after that.

### Fresh Water System

See the POTABLE WATER SYSTEM drawings in the back of this manual for a basic description of this system.

The water filter, located in the accessory room forward of the starboard engine, should be inspected frequently and cleaned as required.

When connected to a dockside water supply, the DC power switch for the water pump should be left in the OFF position.

Sinks and showers ("gray water") drain overboard except for the aft head tub and sink. Sinks above the waterline have gravity drains, while the aft head sink and both showers are pump-drained. The aft pump is located under the floor in front of the stairs. The forward pump is located under the floor between the forward head and the dinette table. Drain pumps should be turned OFF after the shower or aft head sink are drained. The aft head tub and sink drain into a sump box outfitted with a pump and "pop-out" breaker, the sump box pump cannot be turned off.

The water tank is equipped with a water level indicator, located in the AC/DC cabinet on the stbd side of the salon. The indicator may not be 100% accurate, so the water tank should be topped off at every opportunity to avoid the possibility of running short of potable water.

When your boat is to be left unattended for an extended period of time, pump the water tank dry to prevent stored water from becoming stagnant and distasteful. If it should become necessary to disinfect the potable water system, ask your dealer about the treatment systems available and follow the manufacturer's instructions.

### Marine Head System

Refer to the drawings located in the back of this manual and specific literature relative to your yacht's head system.

The system is designed so that waste from either head may be flushed into the holding tank or overboard where regulations permit. Routing is determined by the setting of "Y" valves. Access to the forward head "Y" valve is under the floor between the forward head and the dinette area. Access to the aft head "Y" valve is in the cockpit under the hatch on the forward bulkhead.

The holding tank can be emptied by dockside pump-out or, where permitted, by actuating the macerator pump (with the discharge seacock open) from the pilothouse DC panel. The holding tank is located in the engine room, outboard of the starboard engine.

The holding tank on your Motoryacht has a level indicator. Even so, it is advisable to empty the tank at every opportunity to eliminate the possibility of problems which might be caused by any indicator error. The dockside discharge fitting is located on the starboard side of the deck.

Check with local authorities for regulations covering the legal use of marine head systems in your area.

## Bilge Pumps

Your boat is equipped with three automatic bilge pumps, one located in the aft state room under the aft shelf, one in the engine room aft of the engines and the other beneath the removable floor at the bottom of the forward stateroom stairs. The electric bilge pumps supplied with Bayliners are impeller-type pumps. They are controlled by a switch on the dash panel, which should be activated whenever water begins to accumulate in the bilge. An automatic bilge pump switch ("autofloat switch") is mounted next to each pump. This is a float-type switch that will activate the bilge pump automatically whenever bilge water accumulates above a pre-set level. It is wired directly to the battery so it will normally function even when the boat is completely shut down and unattended, such as when the boat is moored at a marina.

Operation of bilge pumps should be checked frequently. To check bilge pumps, activate the dash-mounted switch and verify that any water in the bilge is pumped overboard. If bilge water is present and the pump motor is running but not pumping, check to see if the pump is clogged with debris. Lift the tab, rotate the fins counter clockwise and lift out the power cartridge (Fig. 1). Clear the housing of debris. To reinstall the power cartridge, first make sure the "O" ring is properly located (Fig. 2). Coat the "O" ring with a light film of vegetable oil or mineral oil. Align the two cams on either side of the power cartridge with the two slots in the outer housing. Press the power cartridge into the housing and twist clockwise. Ensure proper reinstallation by attempting to twist the fins counter clockwise without lifting the tab. The cartridge should stay in place.

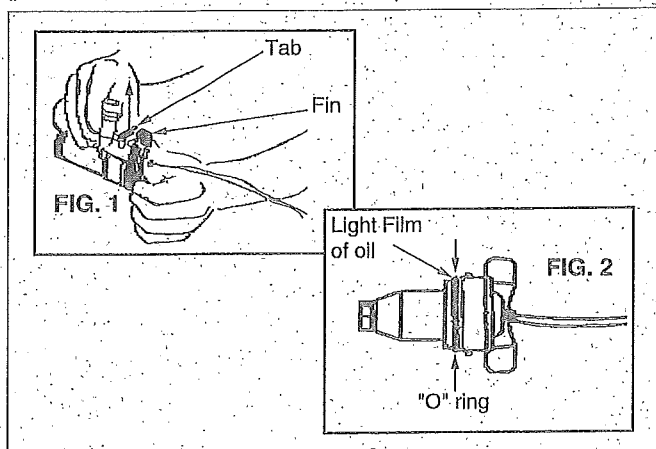

If the pump is clear but still does not move water, check the discharge hose for kinks or a collapsed area.

The autofloat switch should also be checked frequently for proper operation. The plastic insert, where the wires enter the housing, should rotate 1/4 turn counter clockwise (lifting the float).

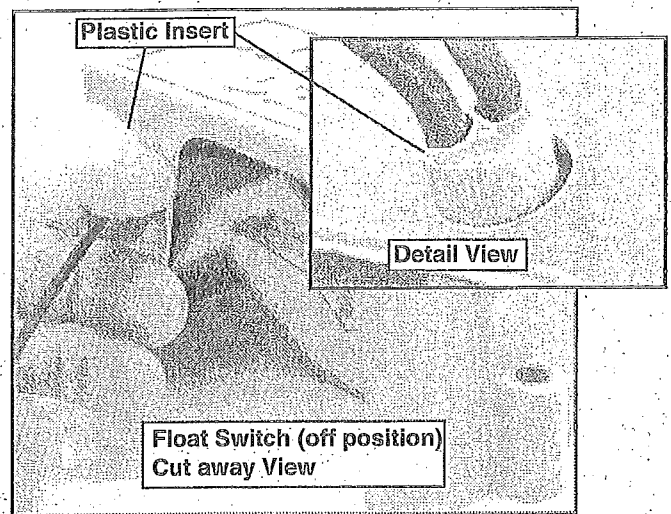

As you raise the float to its full upward position, the bilge pump should turn on.

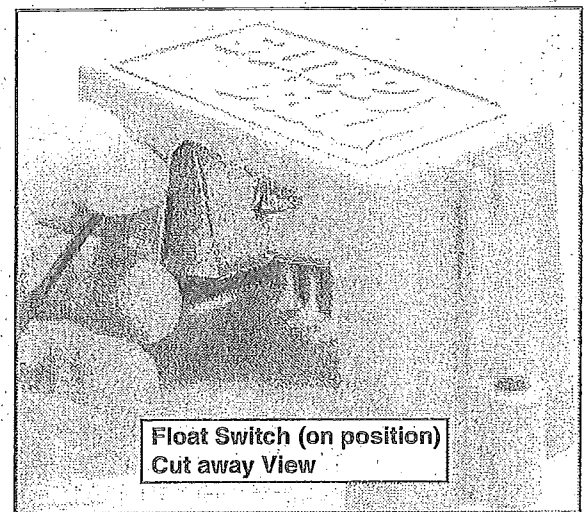

If raising the float does not switch the pump on, check the inline fuse at the battery switch board. Make sure it has not blown. If the fuse is good, but the switch still does not work, it usually indicates a bad switch, or possibly a low battery. In either case, call your dealership for further assistance.

### NOTICE

The Federal Water Pollution Control Act prohibits the discharge of oil or oil waste into or upon the navigable waters and contiguous zone of the United States if such discharge causes a film or sheen upon, or discoloration of, the surface of the water, or causes a sludge or emulsion beneath the surface of the water. Violators are subject to a penalty of \$5000.

## Stereo

---

The stereo that comes standard with your yacht has a separate brochure that explains its operating features. Note that AM radio reception will be impaired anytime the engine is running.

## Depth Sounder

---

Your yacht comes equipped with an electronic depth sounder. It will provide you with measurements of water depth beneath the boat. The depth sounder comes with its own owner's manual. We suggest that you read it carefully before turning on the unit.

### **⚠ WARNING**

The depth sounder should not be used as a navigation aid to prevent collision, grounding, boat damage or personal injury. When the boat is moving, submerged objects will not be seen until they are already under the boat, or bottom depths may change too quickly to allow time for the boat operator to react. Always operate the boat at very slow speeds if you suspect shallow water or submerged objects. The 4087 Motoryacht is not designed to be beached or run aground. Beaching or running aground may cause damage to the hull and/or running gear.

## GENERAL MAINTENANCE AND REPAIRS

In addition to instructions found elsewhere in this manual and in the literature specific to certain components, the following information is provided for general maintenance and repair.

Because conditions vary widely in different areas, and since frequency and type of use can differ greatly between owners, intervals for maintenance are not listed here. Common sense should determine the frequency of maintenance.

### Bilges/Engine Compartment

1. Pump the bilges dry and remove all loose dirt. Be sure all limber holes are open. If there is oil in the bilge and the source is not known, look for leaks in engine oil lines, coolers, transmission or engine gaskets. Oil stains can be removed by using a bilge cleaner available from your dealer or marina. **DO NOT** use flammable solvents.
2. Check all wiring to be sure it is properly supported, that its insulation is intact, and that there are no loose or corroded terminals. If there are corroded terminals, they should be replaced or thoroughly cleaned with sandpaper. Tighten all terminals securely and spray them with a light marine preservative oil.
3. Inspect the entire fuel system (including fill lines, vents, and supply and return lines) for any evidence of leakage. Any stains around joints could indicate a leak. Try a wrench on all fittings to be sure they are not loose, but do not overtighten them. Clean fuel filters and vent screens. Operate all valves to be sure they are in good condition. This is best performed by a qualified mechanic.
4. Inspect the entire bottom for evidence of seepage, damage or deterioration, paying particular attention to hull fittings, hoses, and clamps. Straighten kinked hoses and replace any that do not feel pliable. Tighten loose hose clamps and replace those that are corroded. Tighten any loose nuts, bolts, or screws. Operate seacocks to be sure they are in good condition. Seacocks need lubrication to ensure a long working life.
5. Refer to your engine operating manual for engine maintenance details. Wipe off engines to remove accumulated dust and grease. If a solvent is used, make sure it is nonflammable. Go over the entire engine and tighten loose nuts, bolts, and screws, including the mounts (however, do not turn the mount adjusting screws). Inspect the wiring on the engine and clean and tighten the terminals. Inspect the belts and tighten them if needed. Replace any belt that is cracked or frayed. Clean and lubricate the battery terminals; fill the cells with distilled water as needed.

### Cabin and Topside Areas

1. Test all electrical equipment and appliances to make sure they operate properly. Inspect all wiring for proper support, sound insulation and tight terminals. Pay particular attention to portable appliance cords and plugs.
2. Inspect and operate heads, basins, showers and sinks. Also, inspect the freshwater system plumbing, including the tank. Check and operate the water pumps, including the shower pump and the sink drain pumps. Check all water lines and connections for leaks, and make sure all connections are tight.
3. Check bow rails, ladders, and grab rails for loose screws, breaks, sharp edges, etc. that might be hazardous in rough weather. Inventory and inspect life jackets for tears and deterioration. Check your first aid kit to make sure it is complete. Check the signaling equipment. Inspect anchor, mooring and towing lines and repair or replace as required. **DO NOT** stow wet lines as they may mildew and rot.
4. Salt and brackish water are capable of etching and damaging window glass. Keeping windows clean is the best preventive measure you can take. When window cleaning, flush with plenty of fresh water.

Exercise caution when cleaning windows and doors made of plexiglass because it tends to scratch easily. First, use generous amounts of water to wash off as much dust as possible. Use your bare hands with plenty of water to dislodge any caked dirt. Then use a soft, grit-free cloth or clean, soft sponge with a cleaner made specifically for plexiglass. Never use a glass cleaning solution or a duster, as these will scratch the surface. **DO NOT** use solvents such as acetone, kerosene, benzene, carbon tetrachloride, fire extinguisher fluid, dry cleaning fluid, or lacquer thinner since they will attack the surface. When you are finished, rinse with fresh water and dry with a clean, damp chamois using a blotting action.

5. Your interior teak, with the exception of the galley floor, has been finished with TK 200 Teak Protectant/Restorer from Target Enterprises, Bayliner Part Number 55059.

The procedure for use of the Protectant/Restorer is as follows:

- Sand the teak lightly and remove the dust.
- Apply the teak finish to the teak with a foam brush.
- Sand lightly and remove the dust.
- Apply a final coat of teak finish with a damp rag.

The galley floor has been finished with WB2020 Interior Gloss Finish with CL20 Cross-Linker added from Target Enterprises, Bayliner Part Number 55237-B and 55237-A. The procedure for use of the Interior Gloss



Finish is as follows:

- Mix the floor finish at the rate of 10cc's of Part B per 1 cup of Part A (4% as per the manufacturer's instructions).
- Lightly sand the floor and wipe off the dust.
- Apply a heavy coat of floor finish with a foam brush.
- Allow the finish to dry.
- Sand lightly with 220 grit sandpaper to remove any raised grain and remove the dust.
- Apply another coat of floor finish with a foam brush.
- Sand lightly and remove the dust.
- Apply a final coat of floor finish with a foam brush.

Optional interior ash: Any damaged part should be removed and replaced. When this is not practical, touch-up work should be performed by a highly skilled person. The following procedure was developed for veneer or hard stock:

- Keep surrounding areas covered at all times to prevent overspray damage.
- Lightly sand the entire damaged part with 220 grit sandpaper to rough-up the top coat.
- Using 220/320 grit, sand the area again, feathering one inch beyond the damaged area.
- Fill the damaged wood with matching color putty stick if necessary.
- Use a cotton swab or the corner of a one inch foam brush to sparingly apply touch-up stain (part # 60259).
- The repaired area should now be slightly lighter in color than the surrounding area and will darken during application of the matte finish later in this procedure.
- Allow the stain to dry for at least 30 minutes (slightly longer if cooler than 65 degrees).
- Sand the re-stained area with 600 grit to smooth-up the surface.
- Wipe the sanded area with a water dampened rag or vacuum to remove the dust.
- Use a Binks #15 spray gun or equivalent to apply one coat of matte finish (part # 60000) over the stained area.
- Allow to dry for one hour.
- Sand sprayed area with 600 grit and remove dust with a water dampened rag or vacuum.
- Spray the entire part with one coat of matte finish (part # 60000).

6. Stainless steel railings and fittings should be cleaned with soap and water or household glass cleaner. Because irreversible pitting will develop under rust that remains on stainless steel for any period of time, it is best to remove rust spots immediately with brass, silver or chrome cleaner. Then coat the railing or fitting with a good automobile or boat wax. Never clean with mineral acids or bleaches. Also, do not allow stainless steel to come into continuous contact with iron, steel or other metals which could cause contamination leading to rust or corrosion.
7. A variety of high quality fabrics have been used in the construction of your boat. Proper care and cleaning of all fabrics on a regular basis will contribute to their long life. The most important thing to remember is that stains **must** be cleaned up immediately if the original beauty and strength of the fabric are to be maintained over a long period of time. Independent laboratory testing has shown that some sunscreen lotions and oils can permanently stain most types of vinyls and fabrics, so exercise care when using these products.

Prior to cleaning any fabric, we suggest that you **test your cleaning solution and method on a hidden or inconspicuous area**. That way, if that particular cleaning method causes damage, it will be confined to a small, less noticeable area.

Use a sponge or very soft scrub brush and a mild soap and warm water solution to clean exterior fabrics. Rinse after scrubbing with plenty of cold, clean water and allow the fabric to air dry in a well ventilated place, preferably away from direct sunlight.

Convertible tops and vinyl upholstery can be cleaned using a mild soap and warm water solution also. Rinse after scrubbing with plenty of cold, clean water and air dry in a well ventilated place, again preferably away from direct sunlight. For detailed vinyl cleaning instructions see the Nautolex® insert in your owner's packet.

Vinyl cleaners and conditioners are **NOT** recommended for use on Bayliner upholstery, as they tend to remove plasticizers that extend the life of the fabric. To prevent rainwater seepage at the seams, a coating of *Scotch Gard®*, or similar water repellent, can be applied.

Mildew can occur if your boat does not have adequate ventilation. Heat alone will not prevent mildew; you must also provide for fresh air circulation. If mildew does occur, it often can be removed using a solution of warm water and laundry bleach (one cup of bleach to one gallon of warm water). Brush the solution into the affected area, let it sit for 10 to 15 minutes, and rinse with plenty of cold, clean water. Air dry in a well ventilated place, once again preferably away from direct sunlight.

If at all possible, the vinyl top parts of your boat should be stored indoors in a fairly warm, dry place. This will greatly extend the life of the material.

Dry cleaning should be considered for interior fabrics other than vinyl.

8. When marine instruments are exposed to a saltwater environment, salt crystals may form on the bezel and the plastic covers. These salt crystals should be removed with a soft, damp cloth; never use abrasives or rough, dirty cloths to wipe plastic parts. Mild household detergents or plastic cleaners can be used to keep the instruments bright and clean.

## Hull

1. The finish on a fiberglass boat is similar to that of an automobile and will respond to the same system of care and cleaning.

Use a sponge and a mild soap and warm water solution to clean exterior surfaces of your boat. Rinse the boat well with plenty of clean water. Use a quality boat wax to protect the finish. Note that there are a variety of polishes and cleaners for fiberglass on the market. We suggest that you experiment with different brands to determine which work best for you.

2. Almost unavoidable during the life of your boat is damage to the gelcoat or colored surface. This is not as serious as you might think. Repair is not costly and can be done by the novice.

**Scratches:** If the scratch does not penetrate the gelcoat surface, it can be repaired with automotive rubbing compound. Dampen a soft rag and apply the compound with a continuous circular motion. The scratch may not disappear completely; however, its noticeability will decrease.

**Gouges and Chips:** To repair, obtain "patch paste" from your Bayliner yacht dealer and follow this recommended procedure:

- Clean the area to be repaired of wax and oil. Acetone is a good solvent.
- Mix a small portion of patch paste and catalyst according to the manufacturer's instructions.
- Apply the paste to the gouge with a putty knife or flat-edged stick; try to match the paste to the surface contour of the area being repaired. It is better to have an excess of paste, rather than not enough.
- Allow the paste to harden thoroughly. In most climates, one to two hours should be sufficient.
- Shape the patch as desired, using fine wet sandpaper.
- Finish by using automotive rubbing compound in the same manner as you did for small scratches.

## WARNING

Teak oil, acetone and catalyst are hazardous materials and should be used only in well ventilated areas. Follow the manufacturer's instructions. Also, never store rags that have been wetted with acetone, teak oil, fuel or any other solvent aboard your boat. Immediately remove them from the boat and discard them properly to prevent spontaneous combustion and fire.

3. The bottom paint on your boat is designed to dissolve slowly to prevent marine growth. Therefore, it is unusual to find a boat bottom that does not need repainting after a season's use. Your boat is bottom painted at the factory with International Paint Company's Interlux Fiberglass Bottom Kote #779 Black.

Periodically haul the boat out of the water and scrub the bottom with a bristle brush and a solution of soap and water. It is not always necessary to repaint the bottom each time it is scrubbed, but no bare spots should be permitted.

The recommended procedure for repainting the bottom is as follows:

- Prepare the bottom by sanding, cleaning and fairing as required.
- It is imperative that the new paint be applied over a perfectly dry surface. Fiberglass hulls should never be hauled, painted and relaunched on the same day, since this does not allow sufficient time for the moisture which has been absorbed into the old paint to completely dry out. Generally, 24 - 36 hours of drying time is required.

## NOTICE

Bayliner recommends the application of an epoxy barrier coating, such as International Paint Company's Interlux "Interprotect 2000 or 3000 Systems", to help seal the hull bottom and reduce the possibility of gelcoat blistering on any boat that is moored. The barrier coating should be covered with several coats of antifouling paint. Note that many states regulate the chemical content of bottom paints in order to meet environmental standards. Check with your local Bayliner yacht dealer about recommended bottom paints, and about laws that are in effect in your area.

4. Whenever your boat is out of the water you should check all metal parts for stray current corrosion. Stray current corrosion, or electrolysis, can be prevented several ways. The following are the most common causes and the simplest cures:

- Wiring may leak a certain amount of electricity. Keep a clean, dry bilge.
- A poorly grounded zinc anode: Check the ground wire and clean the contact surfaces.
- The zinc anode may be deteriorated beyond effectiveness; replace it when it has deteriorated 50% or more.
- If your boat is permanently moored, we recommend that you contact someone in your area specializing in corrosion control and have them check your boat in its moorage to see that it is properly protected.

Also, while your boat is out of the water, propellers, rudders, and shafts should be inspected for damage.

5. Every attempt has been made to equip your yacht with propellers that will optimize performance. Changes in altitude and load can affect performance; therefore, your boating needs may dictate a propeller change. Your Bayliner yacht dealer can help you in the selection of propellers better suited to your needs.
6. Your boat is equipped with twin rudders; check to see that they are properly "toed-in" by measuring the distance between the leading edges of both rudders; then measure the distance between the trailing edges. The distance between the leading edges should be 1/4" less than the trailing edges. Adjustment is performed at the transom, inside the engine compartment.

## STORAGE

The following suggestions are offered for storage at the end of your boating season:

1. If your boat is to be stored out of the water, it is extremely important that its hull is properly supported to avoid permanent hull distortion. If your boat is stored inside, it should be in a well-ventilated building. (Refer to the "Sling Locations" drawing which depicts the proper placement for the slings used to lift your yacht. In addition to sling placement, it is important to use the proper spreader beams that place the slings vertical at the lift points).
2. A temporary winter cover is recommended if covered storage isn't available. A proper winter cover should keep the weather off the boat, but still provide adequate ventilation. Wrapping a boat in a tight plastic cover can do more damage than good. Dampness and lack of air circulation provide ideal conditions for the fungi that cause mildew and dry rot.
3. Fill the battery cells with distilled water to the proper level. A fully charged battery will survive storage better than one that is not.

4. Refer to your engine, generator, and accessory owner's manuals for specific storage instructions that apply to that particular component.
5. Drain the freshwater tanks and lines by opening all faucets and operating the water pump (be sure that the hot water tank power switch is turned OFF). Operate the pump until all tanks and lines are empty and no water flows from any of the faucets. Then drain the pump to prevent damage that can result from freezing. Remove the caps from both hot and cold lines to allow any remaining water to drain into the bilge and then overboard through the bilge pumps (hose fittings are located in the engine compartment under the passageway stairs).
6. Flush each head several times. If the boat is to be stored in saltwater, close the intake seacock, add fresh water to the bowl and allow it to stand for a day or more to dissolve accumulated salt. Then, with the seacock closed, flush the head until it is pumped dry. Pump out the holding tank.
7. Where freezing temperatures are likely you may want to use an RV antifreeze in the water systems following the manufacturer's instructions.
8. Fuel tanks should be filled so there is little air space, thereby minimizing condensation.
9. Refer to your engine owner's manual for storage procedures related to the engine seawater cooling system. (Generator cooling system storage provisions are similar to those used for the main engines).
10. Thoroughly clean your boat. If possible, remove cushions, mattresses, blankets, towels, and other items that can hold moisture and cause mildew. Such items left on board should be positioned for maximum air circulation. It helps to stand mattresses and cushions on edge. Prop open doors, hatches, cabinets and ski lockers to allow fresh air to circulate.
11. Defrost and dry out the refrigerator and freezer; leave the doors propped open. Leave all drawers and locker doors open.
12. Clean all deck hardware; then coat the hardware with rust inhibitor.
13. Lubricate the steering mechanism and throttle control linkage.
14. Close all seacocks.
15. Provide as much heat and ventilation for interior spaces as is safe and practical.

We hope these preventive measures will help make getting ready again in the spring easier. Should you have any questions, your Bayliner yacht dealer is ready to provide assistance.

## NAUTICAL TERMS

---

- ABEAM:** ..... To one side of a vessel, at a right angle to the fore-and-aft line.
- AFT:** ..... Near or at the stern.
- BEAM:** ..... The width of the hull.
- BILGE:** ..... The lowest portion inside a boat (in a fiberglass boat, generally the underdeck and lower portion of the engine compartment).
- BOW:** ..... The forward portion of the boat.
- CHINE:** ..... The intersection of the side and bottom of a V-bottom boat.
- DRAFT:** ..... Vertical distance from the waterline of the boat to the lowest point of the boat.
- FATHOM:** ..... A measurement of six feet, generally used to measure water depth.
- FREEBOARD:** ..... Vertical distance from the deck to the waterline.
- GUNWALE:** ..... The upper edge of the side of a boat.
- HATCH:** ..... A deck opening providing access to the space below. Normally fitted with a cover.
- HEAD:** ..... Toilet or toilet room.
- HELM:** ..... The tiller, wheel, and other steering gear.
- KEEL:** ..... The lowest external portion of the hull.
- KNOT:** ..... Nautical mile per hour; one nautical mile is 6,076 ft.; a land mile is 5,280 ft.
- LEE:** ..... The direction toward which the wind blows.
- PORT:** ..... To the left side of the boat facing forward.
- PORTLIGHT:** ..... A hinged window in the boat's cabin or hull.
- SCUPPER:** ..... An opening in a deck or cockpit permitting water to drain overboard.
- STANCHION:** ..... A fixed, upright post used for support (of rails or lifelines).
- STARBOARD:** ..... To the right side of the boat facing forward.
- STERN:** ..... The after portion of the boat.
- STERN DRIVE:** ..... Inboard/outboard propulsion unit.
- TRANSOM:** ..... The transverse part of the stern.
- WINDWARD:** ..... The direction from which the wind is blowing.

Lifting Sling Locations

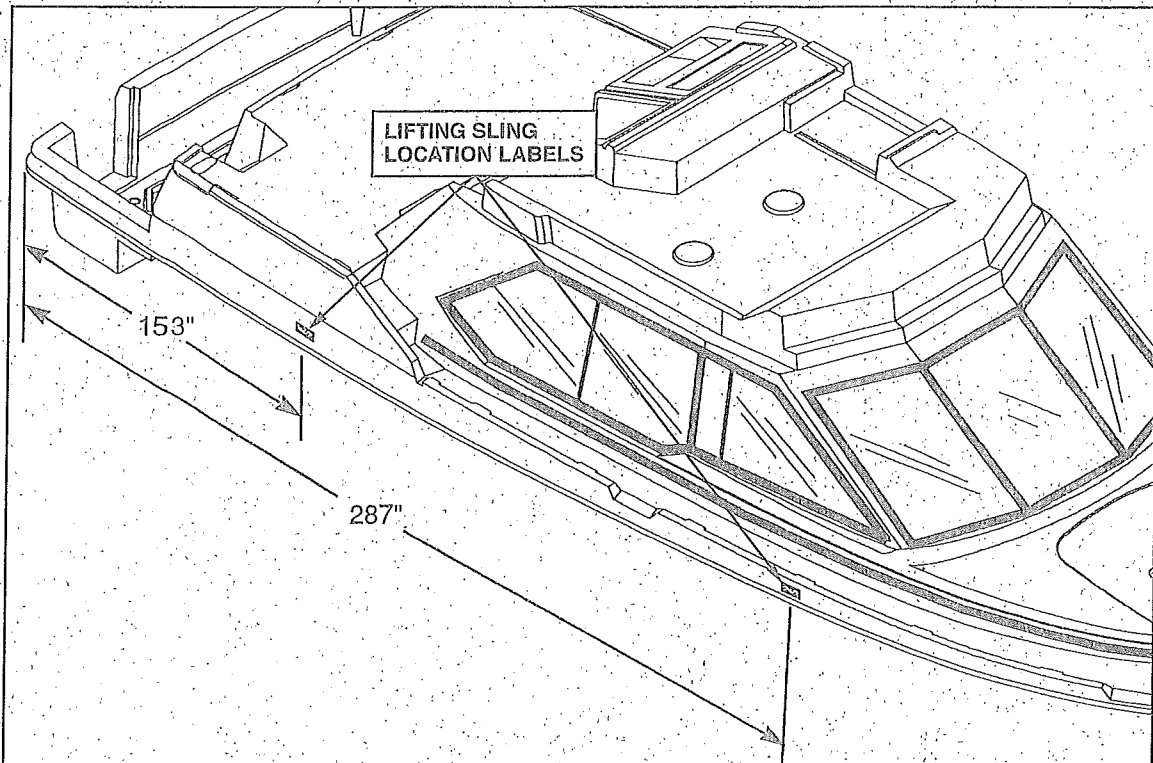

Blower System, Aft

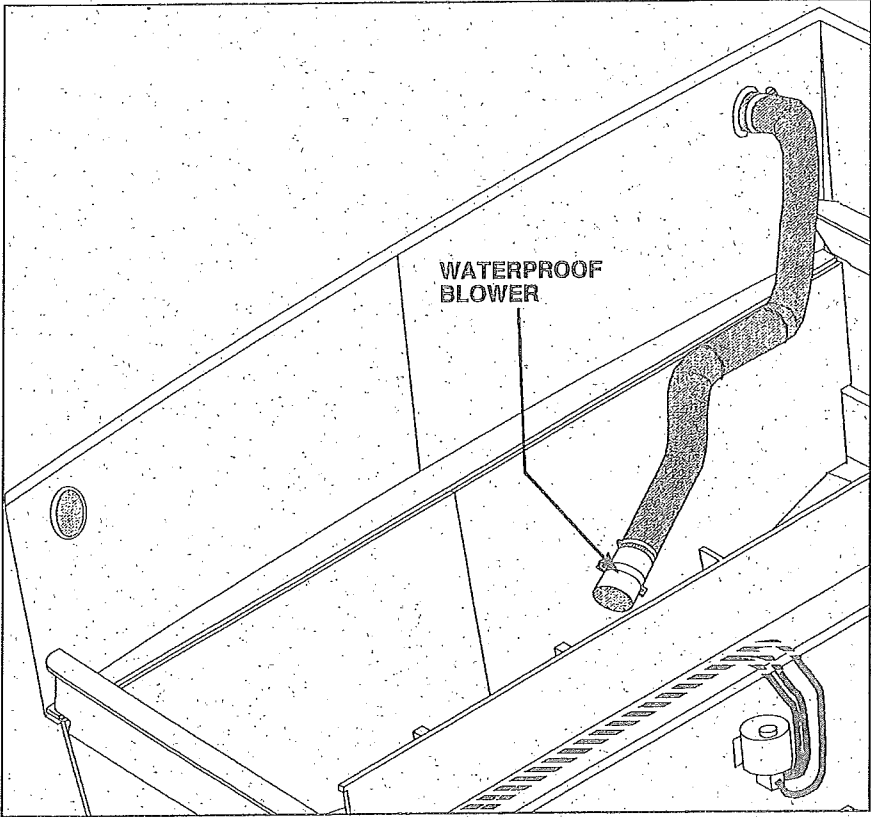

Blower System, Forward

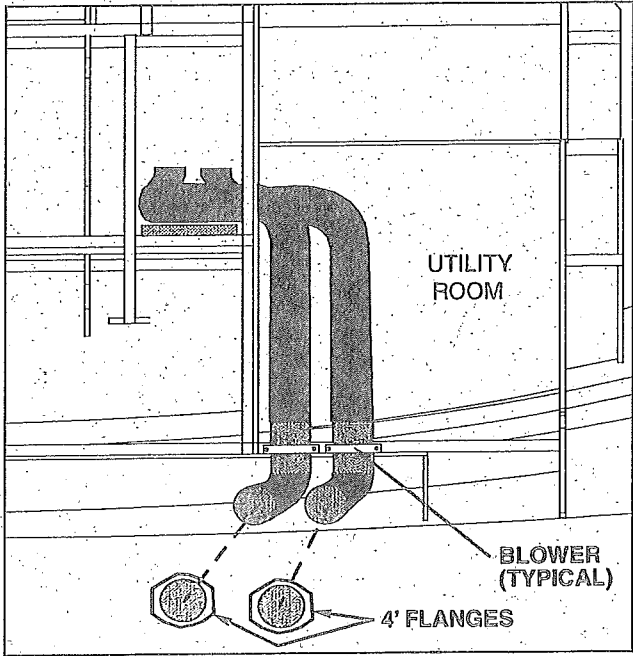

## Steering System

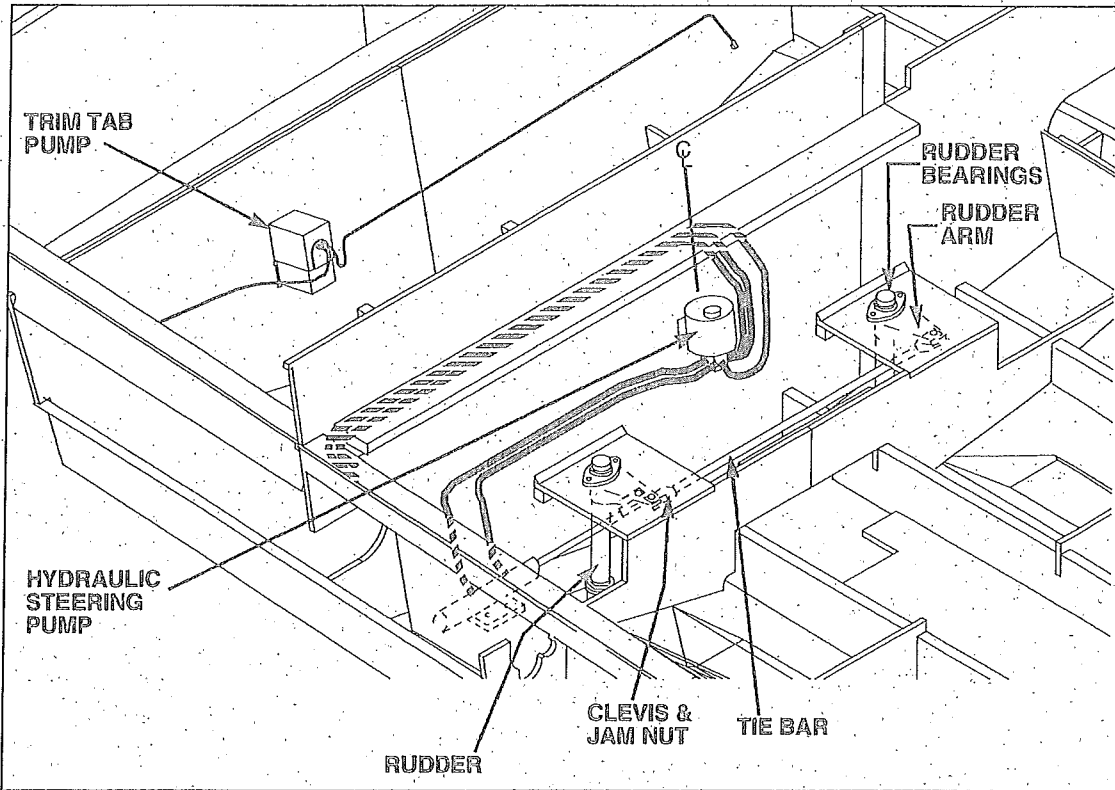

## Shaft Transmission Coupling

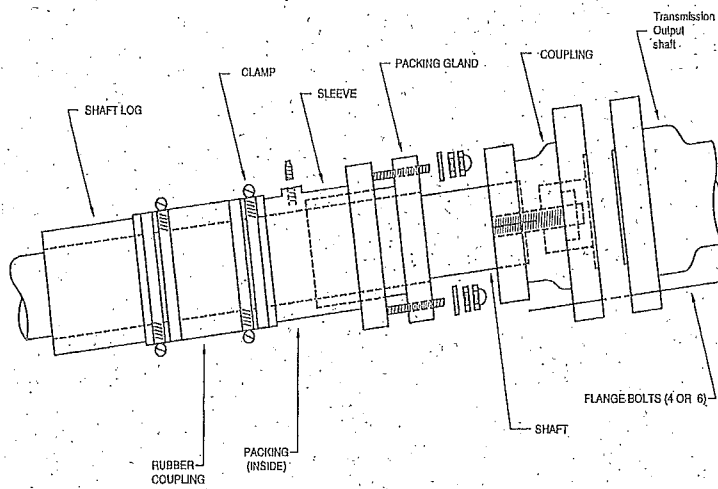

## Heat Exchange System, Gas Engines

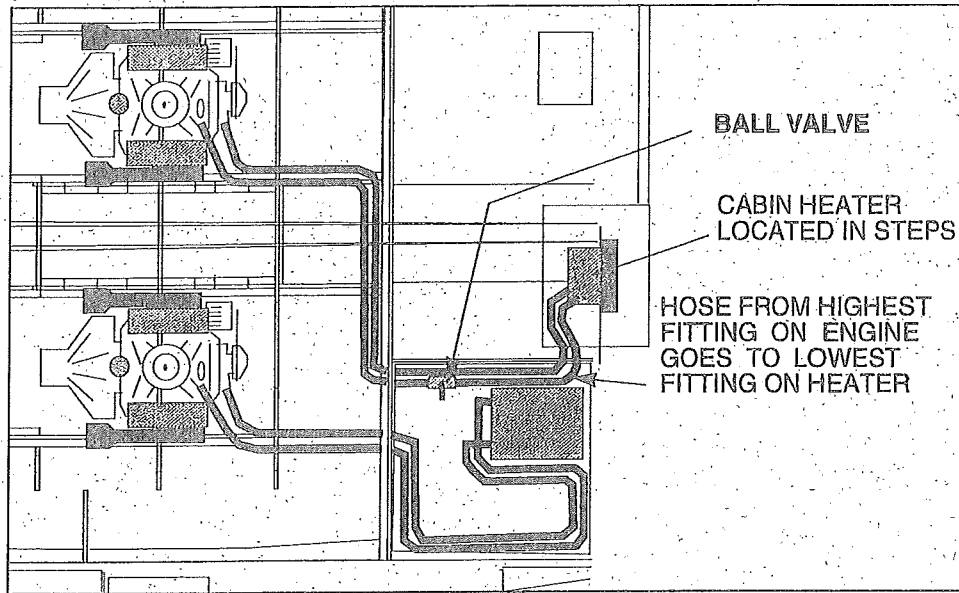

## Heat Exchange System, Diesel Engines

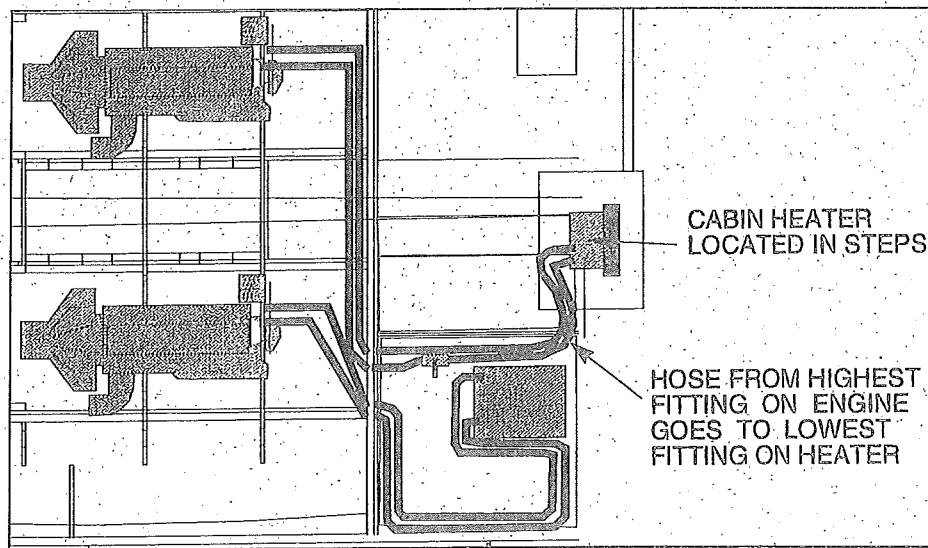



# Bilge Pump System

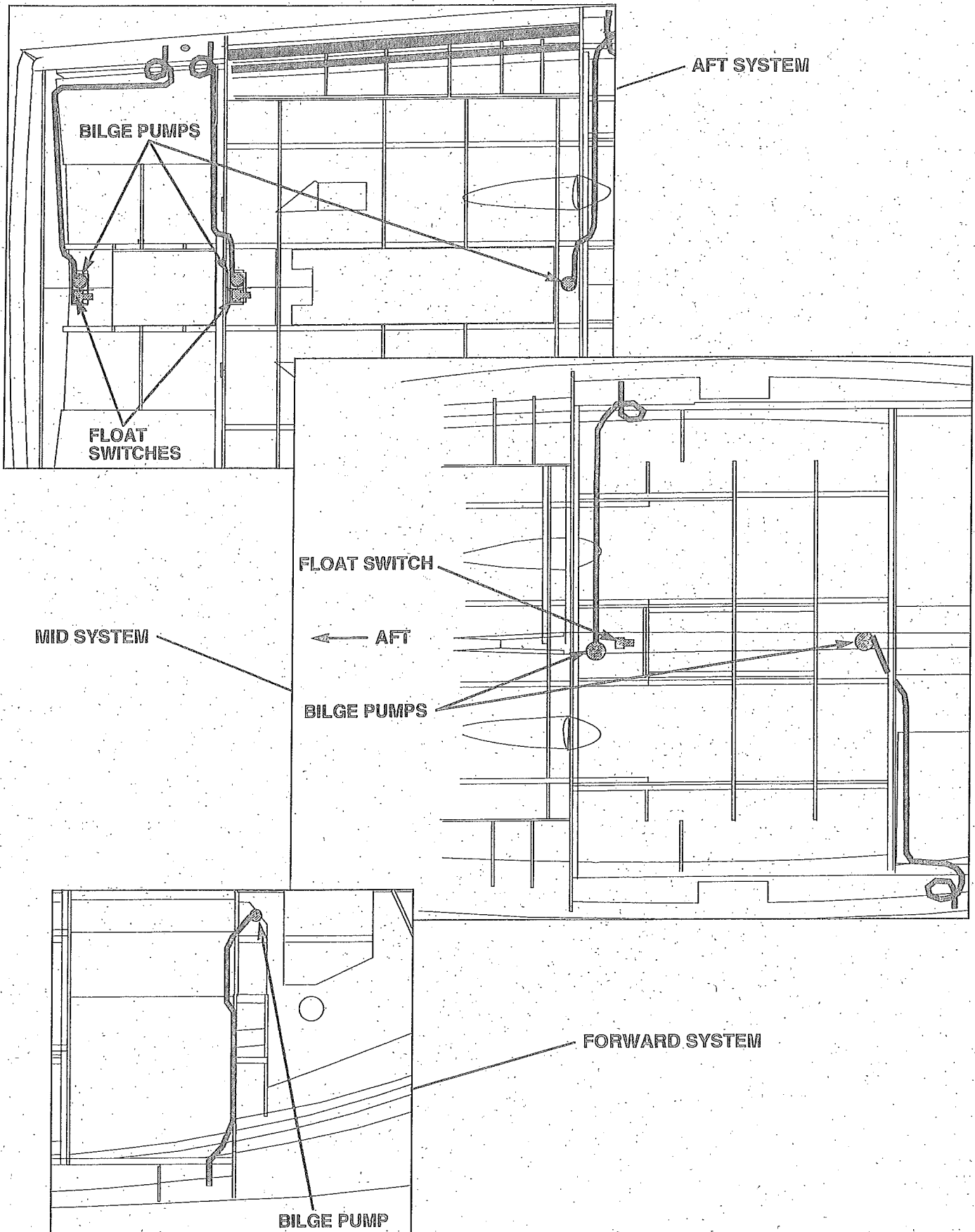

## FRESH WATER SYSTEM

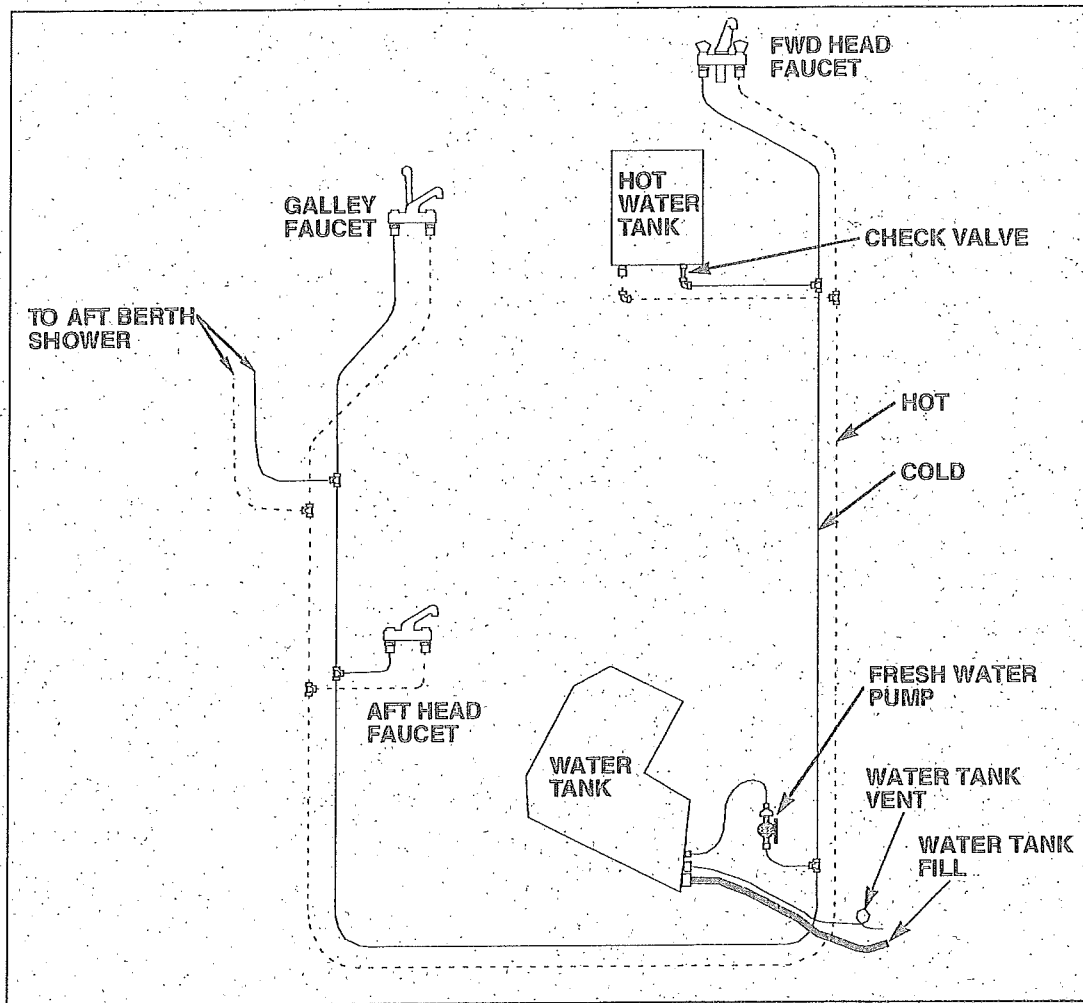

## FRESH WATER SYSTEM OPTIONS

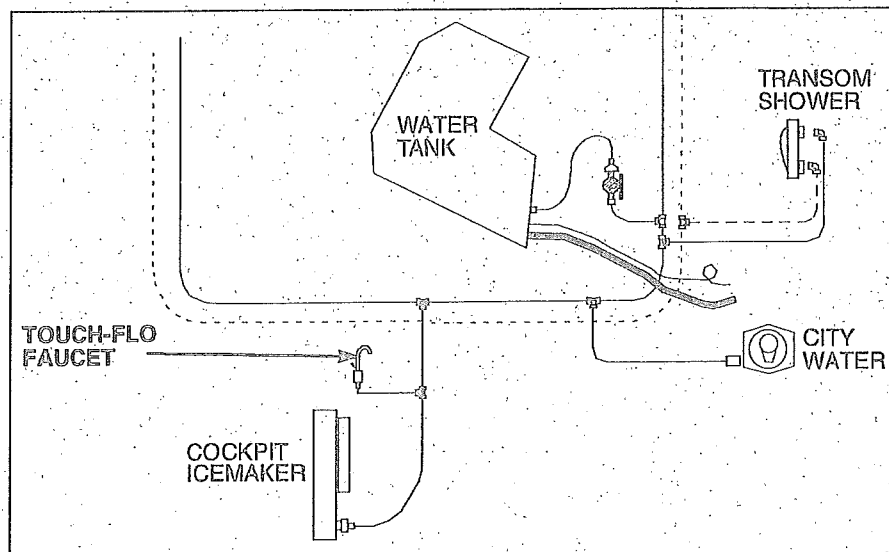

# Shower Drain System

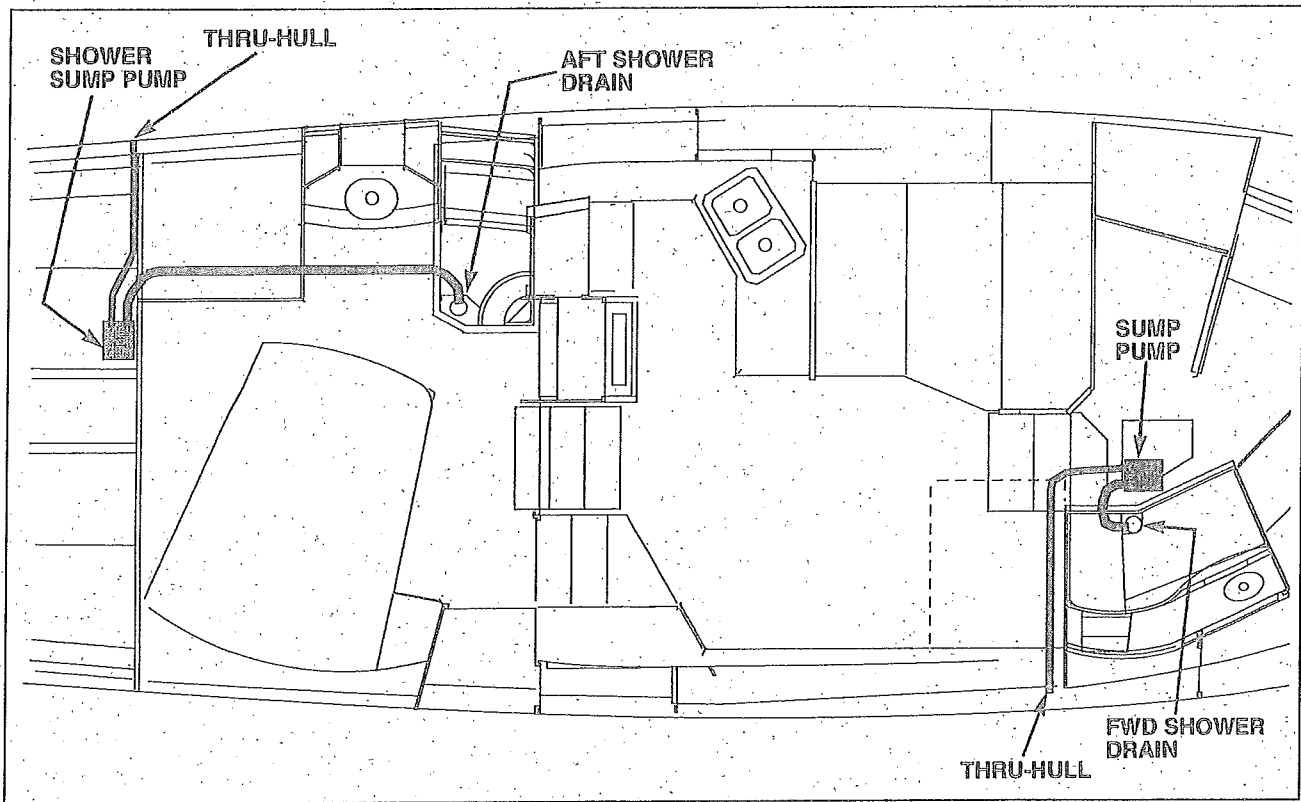

## Air Conditioning, Water Pickup

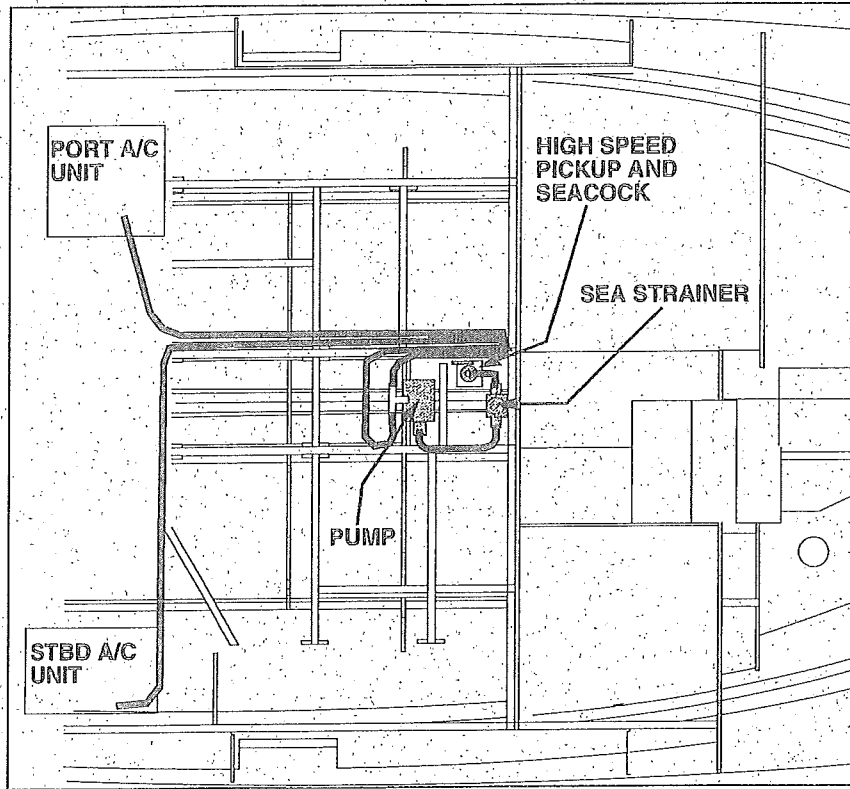

## Air Conditioning, Routing

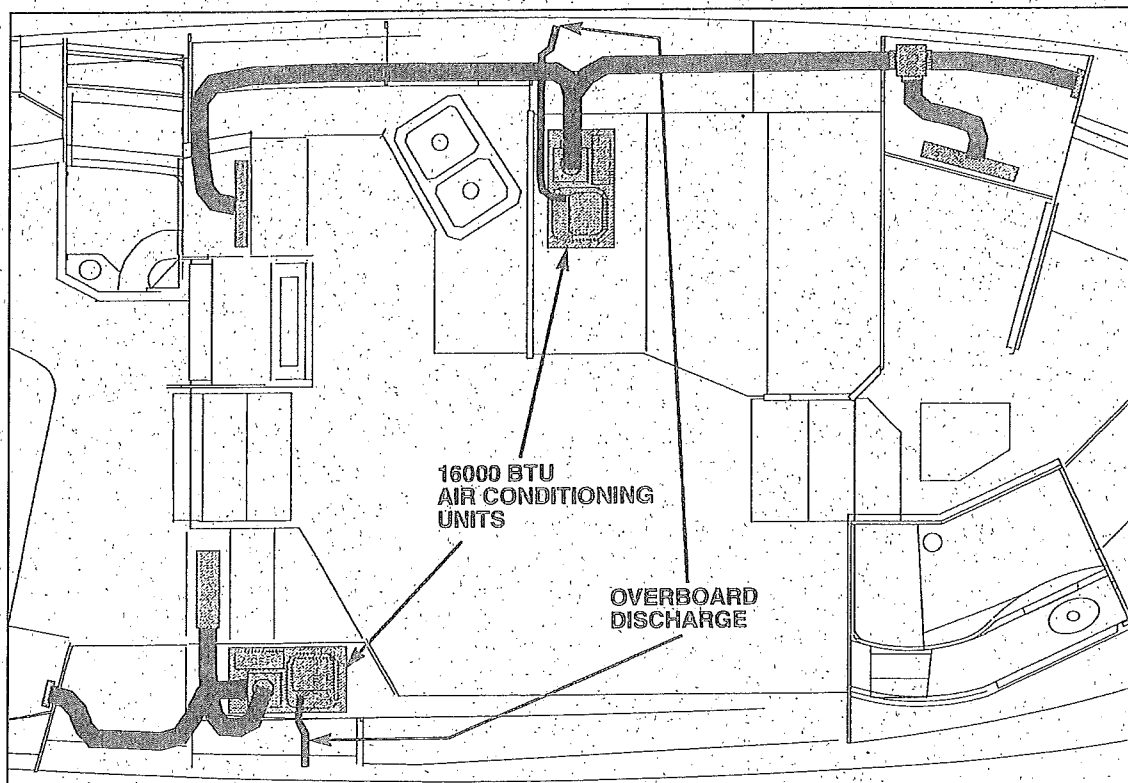

## Marine Head System, Aft

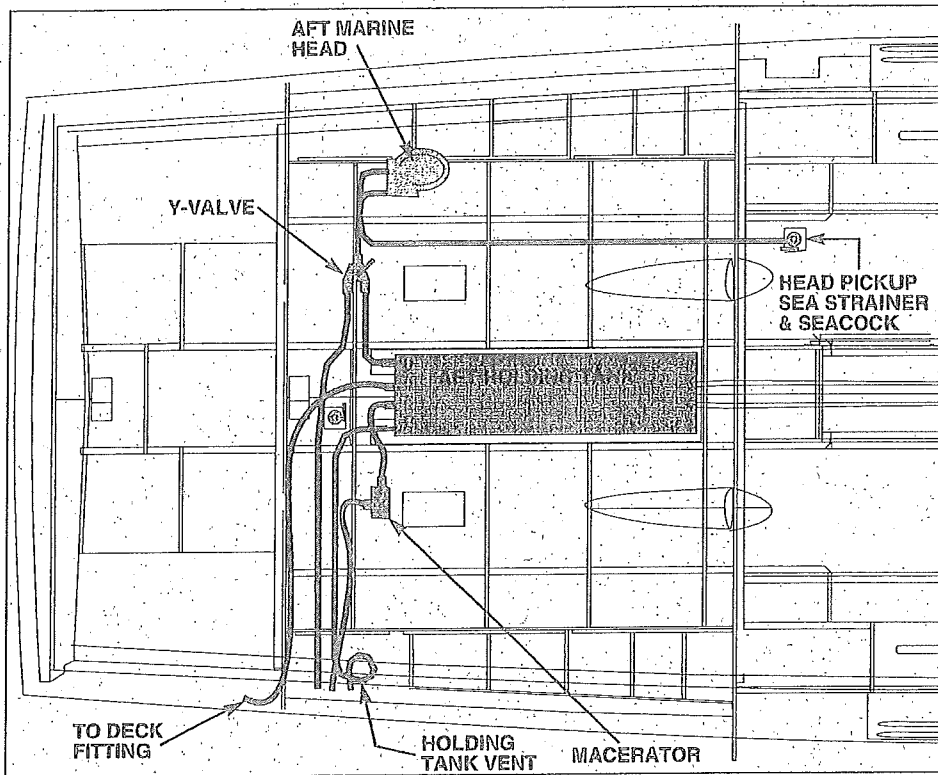

## Fwd Marine Head System

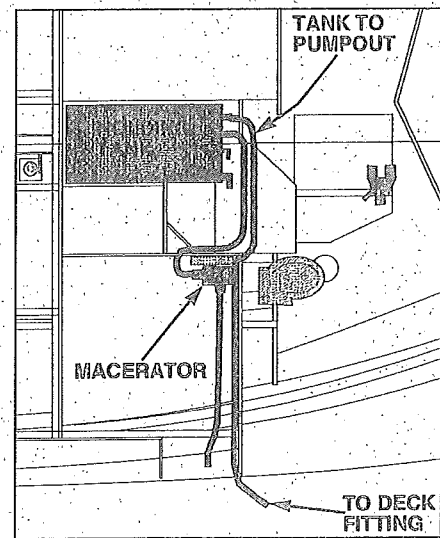
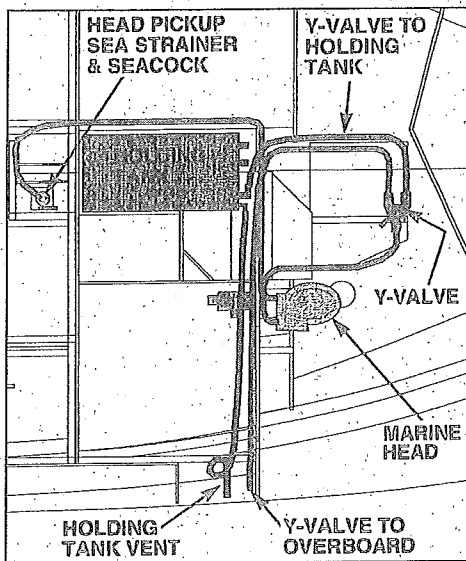

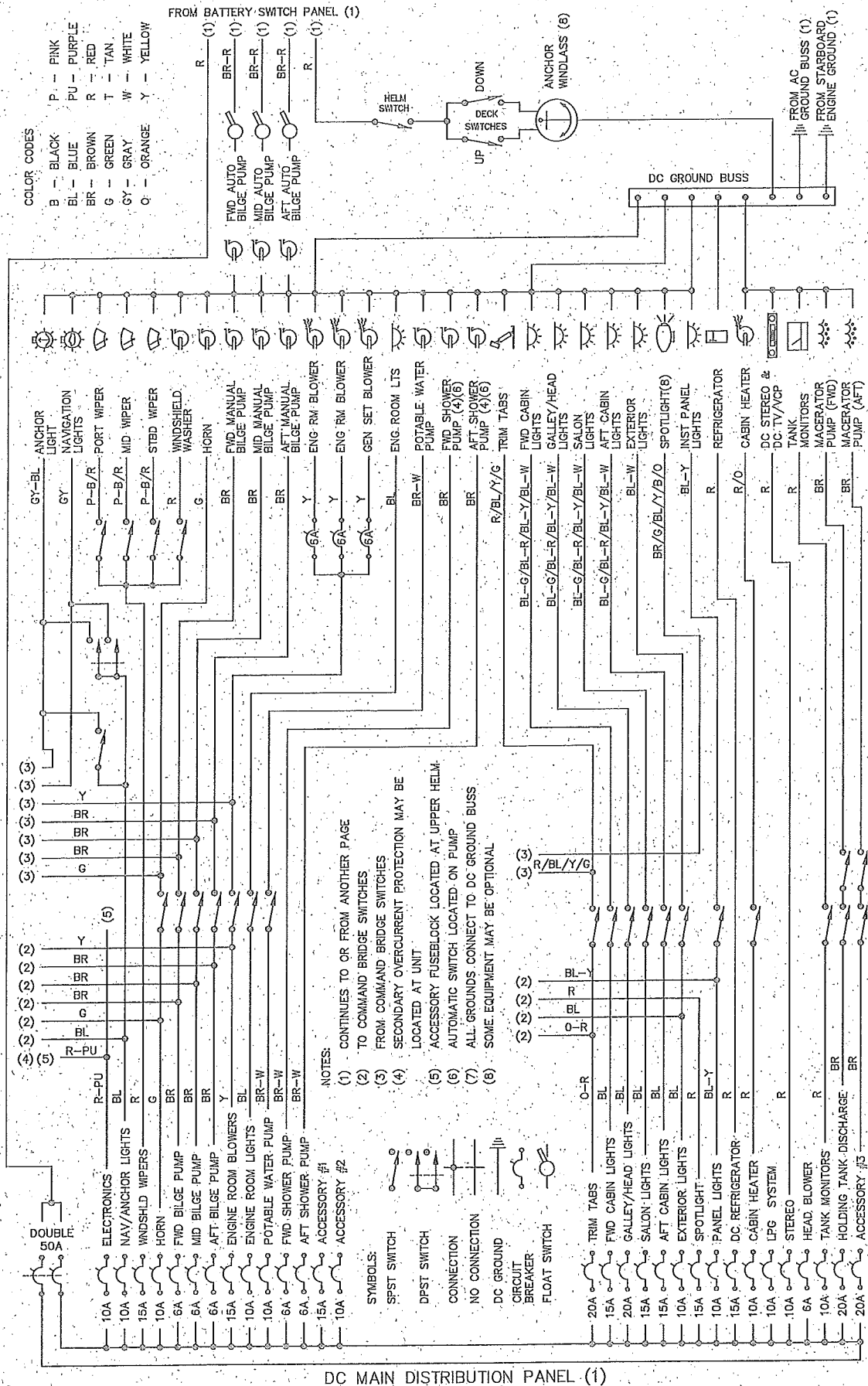

# STANDARD DUAL DOCKSIDE

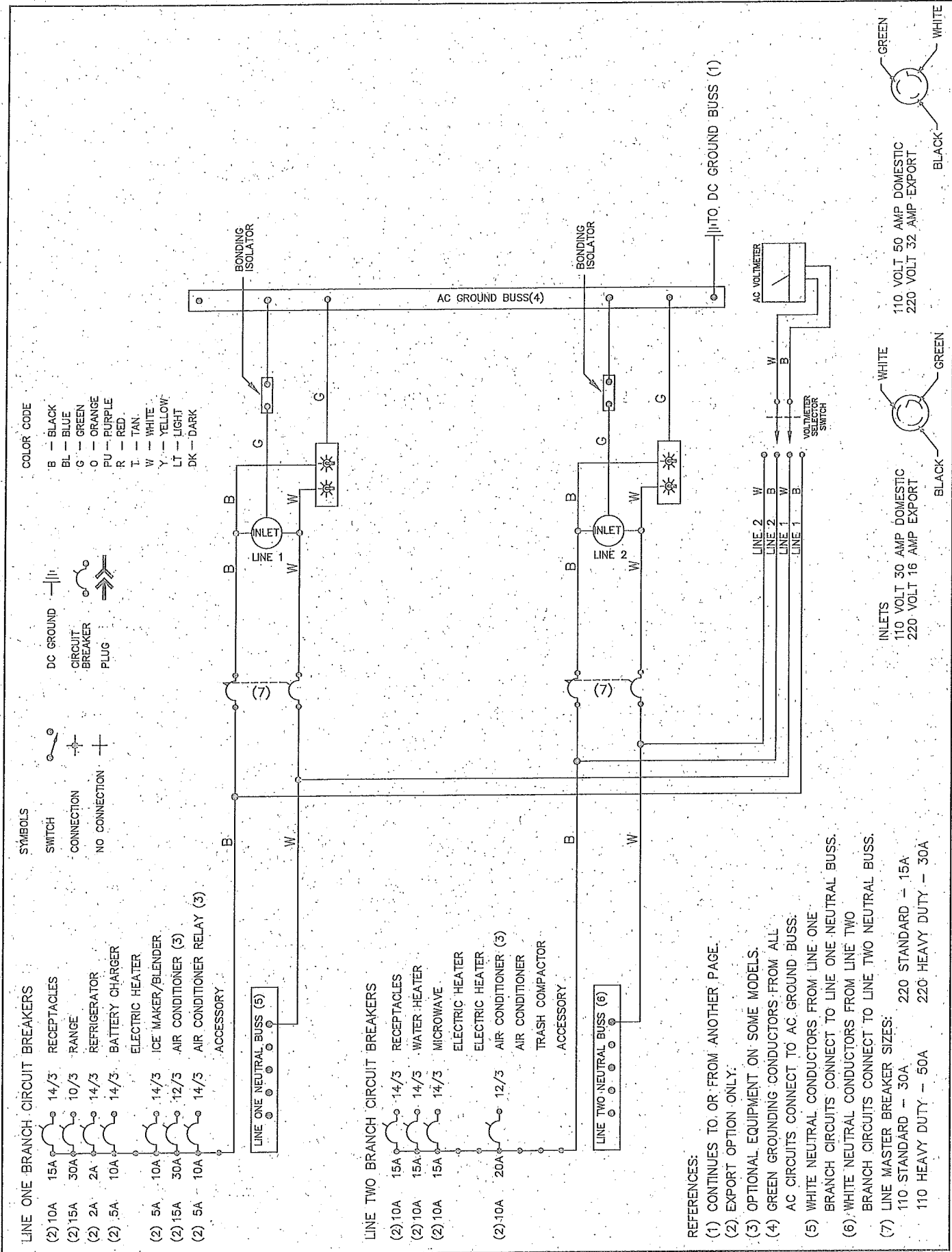

# DUAL DOCKSIDE WITH GENERATOR

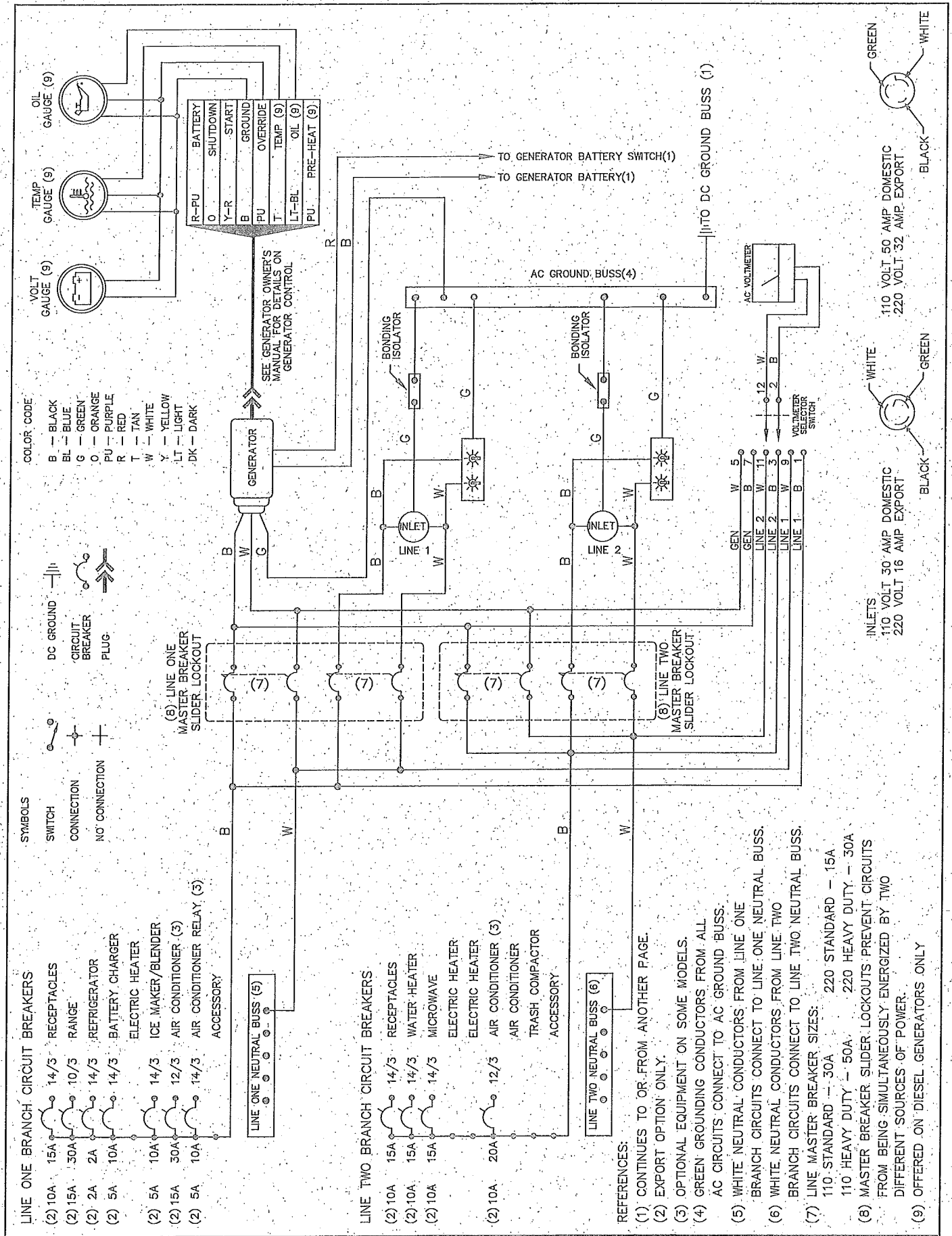



# GAS ENGINE ELECTRICAL SYSTEM

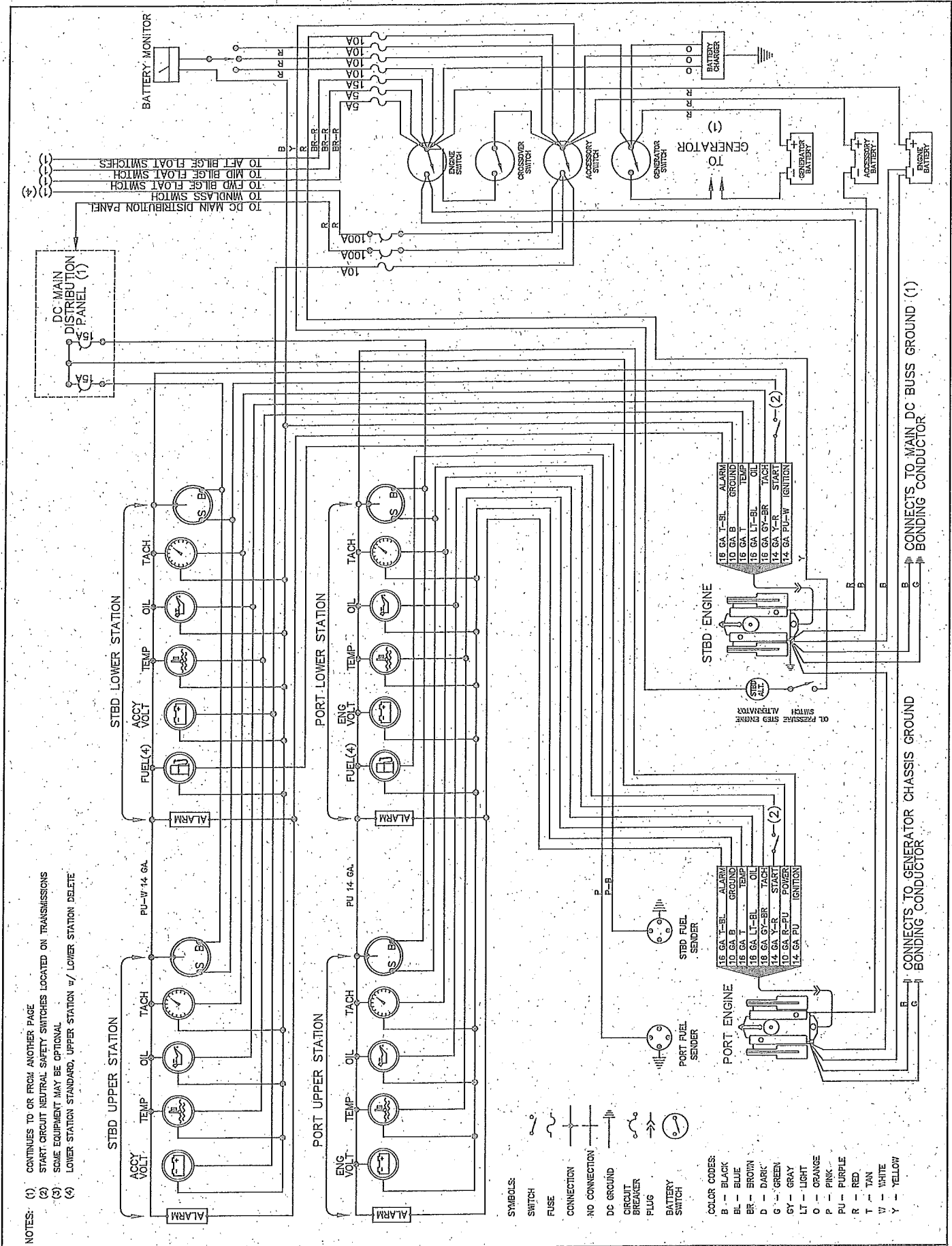

- NOTES:
- (1) CONTINUES TO OR FROM ANOTHER PAGE
  - (2) START CIRCUIT NEUTRAL SAFETY SWITCHES LOCATED ON TRANSMISSIONS
  - (3) SOME EQUIPMENT MAY BE OPTIONAL
  - (4) LOWER STATION STANDARD, UPPER STATION w/ LOWER STATION DELETE

- SYMBOLS:
- SWITCH
  - FUSE
  - CONNECTION
  - NO CONNECTION
  - DC GROUND
  - CIRCUIT BREAKER
  - PLUG
  - BATTERY SWITCH

- COLOR CODES:
- B - BLACK
  - BL - BLUE
  - BR - BROWN
  - D - DARK
  - G - GREEN
  - GY - GRAY
  - LT - LIGHT
  - O - ORANGE
  - P - PINK
  - PU - PURPLE
  - R - RED
  - T - TAN
  - W - WHITE
  - Y - YELLOW

# DIESEL ENGINE ELECTRICAL SYSTEM

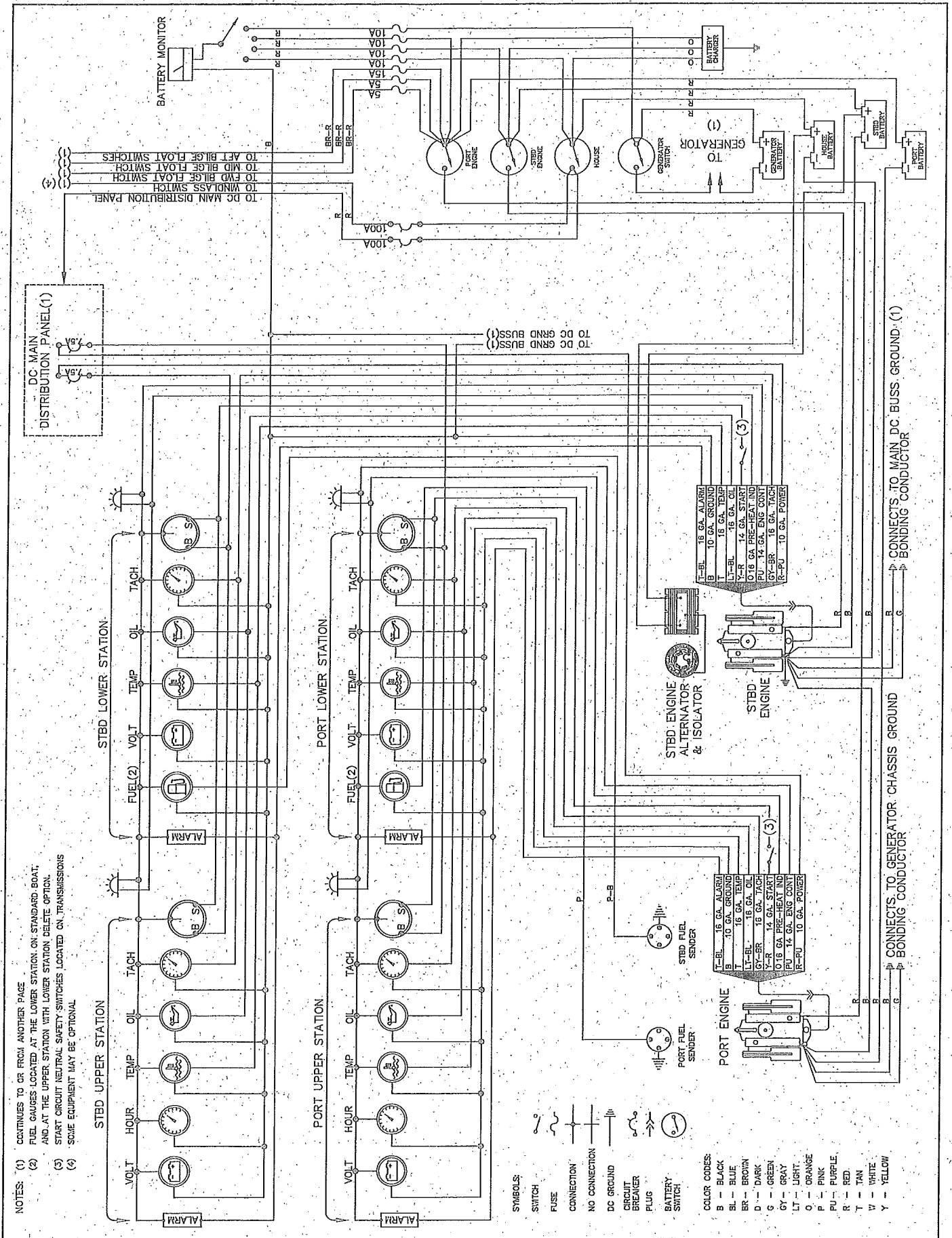

## LIMITED WARRANTY

---

Bayliner warrants to the original purchaser of its 1996 model boats, purchased from an authorized dealer, operated under normal, noncommercial use that the Selling Dealer will:

- A. Repair any structural hull defect which occurs within five (5) years of the date of delivery.
- B. Repair or replace any parts found to be defective in factory material or workmanship within one (1) year of the date of delivery.

## What Is Not Covered

---

**This warranty does not apply to:**

1. Engines, drive trains, controls, props, batteries, or other equipment or accessories carrying their own individual warranties;
2. Engines, parts or accessories not installed by US Marine;
3. Plexiglass windscreen breakage; rainwater leakage on Runabout models; rainwater leakage through convertible tops; minor gelcoat discoloration, cracks or crazing or air voids;
4. Hull blisters that form below the waterline;
5. Normal deterioration, i.e. wear, tear, or corrosion of hardware, vinyl, tops, vinyl and fabric upholstery, plastic, metal, wood, or trim tape;
6. Any Bayliner boat which has been overpowered according to the maximum horsepower specifications on the capacity plate provided on each Bayliner outboard boat.
7. Any Bayliner boat used for commercial purposes;
8. Any defect caused by failure of the customer to provide reasonable care and maintenance.

## Other Limitations

---

**THERE ARE NO OTHER EXPRESS WARRANTIES ON THIS BOAT. TO THE EXTENT ALLOWED BY LAW:**

1. Any implied warranty of merchantability is limited to the duration of this written warranty.
2. **Neither Bayliner nor the Selling Dealer shall have any responsibility for loss of use of the boat, loss of time, inconvenience, commercial loss or consequential damages.**
3. Some states do not allow limitations on how long any implied warranty lasts, so the above limitation may not apply to you. Some states do not allow the exclusion or limitation of incidental or consequential damages, so the above limitation or exclusion may not apply to you. This warranty gives you specific legal rights, and you may also have other rights which vary from state to state.

## Your Obligation

---

**In order to comply with Federal regulations, it is essential that your warranty registration card be submitted within 30 days of delivery of your boat. Return of this card is a condition precedent to warranty coverage. Before any warranty work is performed, we require that you contact your Selling Dealer to request warranty assistance.**

**We require that you return your boat, at your expense, to your Selling Dealer or, if necessary, to the Bayliner factory. You will be responsible for all transportation, haulouts and other expenses incurred in returning the boat for warranty service.**

**Bayliner Marine Corporation  
PO Box 9029  
Everett, WA 98206  
Phone (360) 435-5571**

**P/N 60910**