

**BAYLINER<sup>®</sup>**

**288 Classic**

Owner's Manual *Supplement*



**Engine Serial Number:** \_\_\_\_\_

**Hull Identification Number:** \_\_\_\_\_

**Hull Identification Number**

- The Hull Identification Number (HIN) is located on the starboard side of the transom.
- Record the HIN (and the engine serial numbers) in the space provided above.
- Include the HIN with any correspondence or orders.

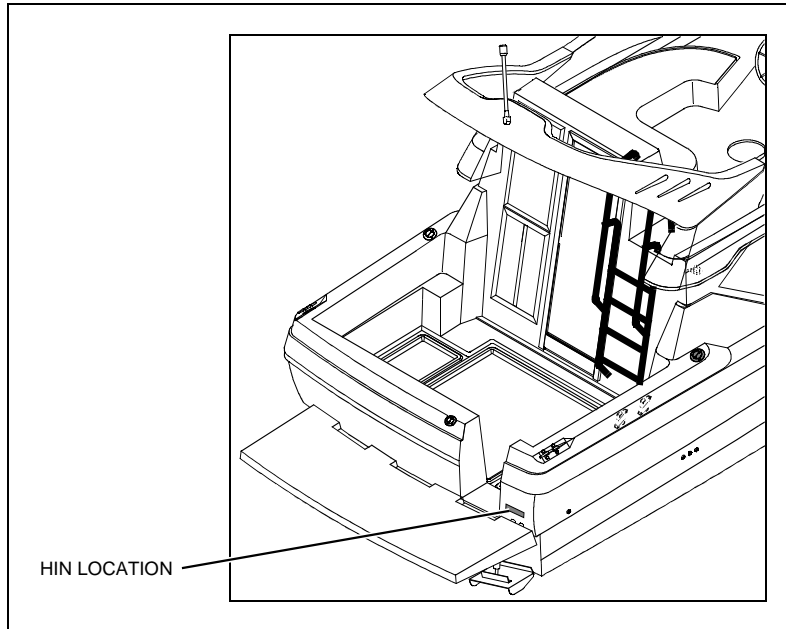

**© 2005 Bayliner Technical Publications. All rights reserved.**

No part of this publication may be reproduced, stored in any retrieval system, or transmitted in any form by any means, electronic, mechanical, photocopying, recording or otherwise, without prior written permission of Bayliner.  
Printed in the United States of America.

**General Notes**

The material in this document is for information only and is subject to change without notice. While reasonable efforts have been made in the preparation of this document to assure its accuracy, Bayliner assumes no liability resulting from errors or omissions in this document, or from the use of information contained herein.

Due to our commitment to product improvement, Bayliner reserves the right to make changes in the product design, specifications, and equipment at any time without notice or obligation. Illustrations and/or photos may show optional equipment.

All Bayliner products meet or exceed USCG (United States Coast Guard) and/or NMMA (National Marine Manufacturer's Association) construction standards. Manufactured with 1,1,1 Trichloroethane, a substance which harms public health and environment during the manufacturing process by destroying ozone in the upper atmosphere.

**Proprietary Rights**

This document discloses subject matter in which Bayliner has proprietary rights. The information and design disclosed herein were originated by and are the property of Bayliner. Neither receipt nor possession thereof confers or transfers any right to reproduce, copy, alter or disclose the document or any part thereof, any information contained therein, or to construct boats or any item from it, except by written permission from or written agreement with Bayliner. This document is to be returned upon request to Bayliner.

288 Classic

# CONTENTS

---

## Chapter 1: Welcome Aboard!

Dimensions and Tank Capacities	1
Layout View	1
Dealer Service	1
Warranty Information	1
Boating Experience	2
Structural Limitations	2
Qualified Maintenance	2
Engine & Accessory Guidelines	3
<i>Engine &amp; Accessory Literature</i>	3
<i>Propeller</i>	3
Safety Standards	4
Special Care for Moored Boats	5
<i>Sacrificial Anode (Zinc)</i>	5
Boat Lifting	6
Carbon Monoxide (CO)	7
<i>Facts about CO</i>	7
<i>Where and How CO Can Accumulate</i>	8
<i>How to Protect Yourself and Others From CO</i>	8
<i>CO Checklists</i>	9
<i>CO Monitors</i>	9
<i>More Information</i>	10

## Chapter 2: Locations

Exterior Views	11
<i>Hull Views</i>	11
<i>Deck View</i>	12
<i>Helm</i>	13
Component Locations	14

## Chapter 3: Propulsion & Related Systems

Engine	26
Diesel Engine Cooling System (If Equipped)	26
Bilge Blower System	27
Fuel System	28
<i>Fuel Fill &amp; Vent</i>	29
<i>Anti-siphon Valve (Gas Engine Only)</i>	29
<i>Gas Engine Fuel Filters</i>	30
<i>Fuel Filter/Water Separator (Diesel Engine Only)</i>	30
Quick Oil Drain System	31

## Chapter 4: Controls & Gauges

Steering	32
<i>Hydraulic Steering System</i>	32
Shift/Throttle Controls	32
Power Trim & Tilt	32
Trim Tabs	33
Gauges	34
<i>Cleaning the Gauges</i>	34
<i>Gauge Fogging</i>	34
<i>Radio Transmission Interference</i>	34
<i>Fuel Gauge</i>	34

## Chapter 5: Navigation & Communication Equipment

Compass	35
Depth Finder	35
VHF Radio (If Equipped)	35

## Chapter 6: Plumbing

Bilge Pumps	36
<i>Bilge Pump Testing</i>	37
<i>Autofloat Switches</i>	38
Seawater Systems	39
<i>Seacocks</i>	39
<i>Seawater Strainers</i>	39
Freshwater System	40
<i>Freshwater System Winterization</i>	41
<i>Water Heater</i>	42
<i>Winterizing the Water Heater</i>	42
Drain Systems	43
<i>Deck Drains</i>	43
<i>Gray Water Gravity Drains</i>	43
<i>Sump Box Cleaning</i>	43
<i>Sump System Winterization</i>	43
Marine Head & Holding Tank	44
<i>Macerator (If Equipped)</i>	44

## Chapter 7: Deck Equipment

Cleats & Tow Eyes	45
Canvas	45
<i>Canvas Care</i>	46
<i>Clear Vinyl Care</i>	47
Pre-wiring For Windlass	48

---

## **Chapter 8: Appliances & Entertainment Systems**

Refrigerator 49

Audio Equipment 49

Alcohol/Electric Stove 50

## **Chapter 9: Convertible Seats, Beds, & Tables**

Dinette to Berth Conversion 51

## **Chapter 10: Lights**

Care and Maintenance 52

Interior & Exterior Lights 52

Navigation Lights 52

## **Chapter 11: Air Conditioning System (If Equipped)**

## **Chapter 12: Electrical System**

12-Volt DC System 55

*Batteries 55*

*Battery Switch 55*

*Battery Switch Positions 55*

*Fuses & Circuit Breakers 56*

*12-Volt DC Accessory Outlets 56*

*Alternator 56*

*Battery Charger (If Equipped) 56*

110-Volt AC System 57

*Shore Power 58*

*Connecting to Shore Power 59*

*Parallel Switch (Only if Equipped with Dual Shore Power) 59*

Electrical Routings 60

*110-Volt AC Hull Harnesses Routing System 60*

*12-Volt DC Hull Harnesses Routing System 61*

*12-Volt DC Deck Harness Routings 62*

*Battery Cable Routings 63*

Wiring Diagrams 64

*110-Volt AC Electrical System Single Dockside 64*

*110-Volt AC Electrical System Dual Dockside 65*

*Engine Electrical System 66*

## **Important Records 67**

## **Float Plan 68**

## Hazard Boxes & Symbols

The hazard boxes and symbols shown below are used throughout this supplement to call attention to potentially dangerous situations which could lead to either personal injury or product damage. Read *all* warnings carefully and follow *all* safety instructions.

 **DANGER!**  
This box alerts you to immediate hazards which *WILL* cause severe personal injury or death if the warning is ignored.

 **WARNING!**  
This box alerts you to hazards or unsafe practices which *COULD* result in severe personal injury or death if the warning is ignored.

 **CAUTION**  
This box alerts you to hazards or unsafe practices which *COULD* result in minor personal injury or cause product or property damage if the warning is ignored.

**NOTICE**  
This box calls attention to installation, operation or maintenance information, which is important to proper operation but is not hazard related.

 FIRE HAZARD!	 EXPLOSION HAZARD!	 NO OPEN FLAME!	 ELECTRICAL HAZARD!	 HOT HAZARD!
---	--	---	--	--

 FALLING HAZARD!	 ROTATING PROPELLER HAZARD!	 RUN BILGE BLOWERS FOR 4 MINUTES!
--	---	--

  
**DANGER**  
CARBON MONOXIDE  
CO POISONING HAZARD!

## Chapter 1: Welcome Aboard!

- This *Owner's Manual Supplement* provides information about your boat that is **not** covered in the *Cruiser & Yacht Owner's Manual*.
- **Before** using your boat, study this *Owner's Manual Supplement*, the *Cruiser & Yacht Owner's Manual*, and **all** engine and accessory literature carefully.
- Keep this *Owner's Manual Supplement* and the *Cruiser & Yacht Owner's Manual* on your boat in a secure, yet readily available place.

### Dimensions and Tank Capacities

Overall Length	Length Rigged	Bridge Clearance	Beam	Draft (Hull)	Draft (Maximum)	Fuel Capacity	Freshwater Capacity	Holding Tank Capacity
30' 8"	32' 11"	10' 3"	10' 0"	1' 8"	3' 2"	113 Gallons	34 Gallons	26 Gallons

### Layout View

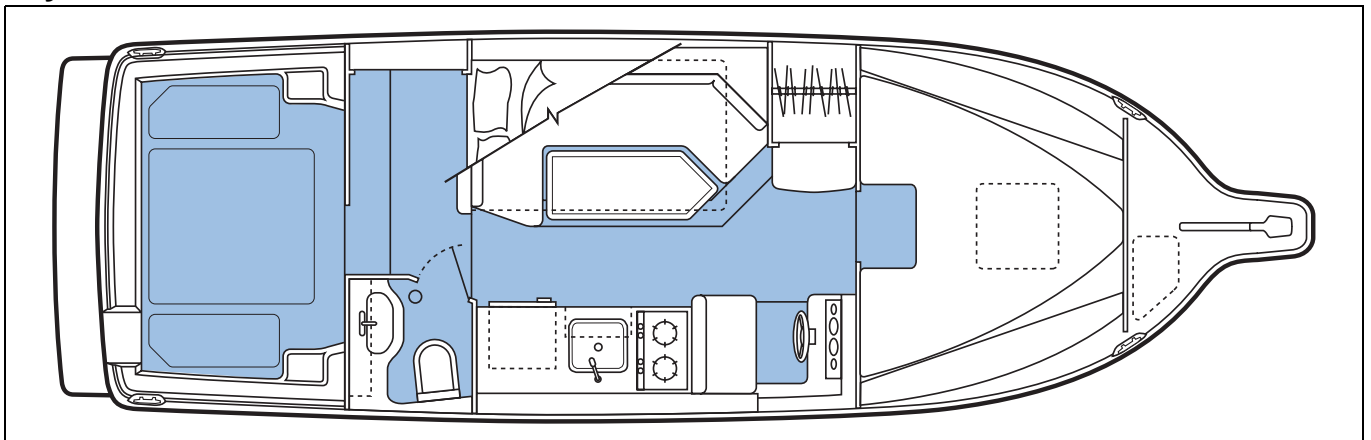

### Dealer Service

- Your dealer is your key to service.
- Ask your dealer to explain **all** systems **before** taking delivery of your boat.
- Contact your dealer if you have any problems with your new boat.
- If your dealer cannot help, call our customer service hotline: 360-435-8957 or send us a FAX: 360-403-4235.
- Buy replacement parts from any authorized Bayliner dealer.

### Warranty Information

- Bayliner offers a Limited Warranty on each new Bayliner purchased through an authorized Bayliner dealer.
- A copy of the Limited Warranty was included in your owner's packet.
- If you did not receive a copy of the Limited Warranty, please contact your Bayliner dealer or call 360-435-8957 for a copy.

## Boating Experience

 <b>WARNING!</b>
<b>CONTROL HAZARD!</b>
<b>A qualified operator <i>MUST</i> be in control of your boat at <i>ALL</i> times. Do <i>NOT</i> operate your boat while under the influence of alcohol or drugs.</b>

If this is your first boat or if you are changing to a type of boat you are *not* familiar with, for your own comfort and safety, get handling and operating experience *before* assuming command of your boat.

Take one of the boating safety classes offered by the U.S. Power Squadrons or the U.S. Coast Guard Auxiliary. For more course information, including dates and locations of upcoming classes, contact the organizations directly:

- U.S. Power Squadrons: 1-888-FOR-USPS (1-888-367-8777) or on the Internet at: <http://www.usps.org>
- In Canada, for the CPS courses call 1-888-CPS-BOAT.
- U.S. Coast Guard Auxiliary: 1-800-368-5647 or on the Internet at: <http://www.cgaux.org>

Outside the United States, your selling dealer, national sailing federation, or local boat club can advise you of local sea schools or competent instructors.

## Structural Limitations

The swim platform, and radar wing are designed to be lightweight for proper boat balance. The load limit for these structures is 30 pounds per square foot, evenly distributed.

## Qualified Maintenance

 <b>WARNING!</b>
<b>To maintain the integrity and safety of your boat, allow <i>ONLY</i> qualified personnel to perform maintenance on, or change, in any way, the:</b>
<ul style="list-style-type: none"> <li>• <b>Steering system</b></li> <li>• <b>Propulsion system</b></li> <li>• <b>Engine control system</b></li> <li>• <b>Fuel system</b></li> <li>• <b>Environmental control system</b></li> <li>• <b>Electrical system</b></li> <li>• <b>Navigational system</b></li> </ul>

- Failure to maintain your boat's systems (listed in the warning above) as designed could violate the laws in your jurisdiction and could expose you and other people to the danger of bodily injury or accidental death.
- Follow the instructions provided in the *Cruiser & Yacht Owner's Manual*, this *supplement*, the engine owner's manual, and *all* accessory literature.



## Engine & Accessory Guidelines

### NOTICE

When storing your boat, please refer to your engine's operation and maintenance manuals.

### NOTICE

Certain modifications to your boat **WILL** result in cancellation of your warranty protection. **ALWAYS** check with your dealer **BEFORE** making any modifications to your boat.

- Your boat's engine and accessories were selected to provide optimum performance and service.
- Installing a different engine or other accessories may cause unwanted handling characteristics.
- Should you choose to install a different engine or accessories that will affect your boat's running trim, have an experienced marine technician perform a safety inspection and handling test **before** operating your boat again.

### Engine & Accessory Literature

- The engine and accessories installed on your boat come with their own operation and maintenance manuals.
- Read these manuals **before** using the engine and accessories.
- Unless noted otherwise, **all** engine and accessory literature referred to in this *supplement* is included in your owner's packet.

### Propeller



### CAUTION

#### **ENGINE DAMAGE HAZARD!**

The factory standard propeller may not be the best for your particular boat and load conditions. Refer to the engine manual for engine RPM ratings. The engine should reach, but not exceed its full rated RPM when full-throttle is applied.

Immediately contact your local Bayliner dealer if:

- The engine cannot reach its full rated RPM when full-throttle is applied, or;
- The engine exceeds its full rated RPM when full-throttle is applied.

- Keep the propeller in good repair and at the correct pitch for your particular situation.
- A slightly bent or nicked propeller will adversely affect the performance of your boat.

## Safety Standards

**⚠ DANGER!**



***FALLING and ROTATING PROPELLER HAZARD!***

- ***NEVER*** allow anyone to ride on parts of your boat ***NOT*** designed for such use.
- ***Sitting on seat backs, lounging on the forward deck, bow riding, gun-wale riding or occupying the transom platform while underway is especially hazardous and WILL cause personal injury or death.***

**⚠ DANGER!**





***FALLING, ROTATING PROPELLER and CARBON MONOXIDE POISONING HAZARD!***

- ***NEVER*** allow anyone to occupy, or hang from, the back deck or swim platform while the engine(s) are running.
- ***Teak surfing, dragging, or water skiing within 20 feet of a moving watercraft can be fatal.***

**⚠ DANGER!**

***PERSONAL SAFETY HAZARD!***

- ***ALWAYS*** secure the anchor and other loose objects ***BEFORE*** getting underway.
- ***The anchor and other items that are NOT properly secured can come loose when your boat is moving and cause personal injury or death.***

**⚠ WARNING!**

**A wide variety of components used on this vessel contain or emit chemicals known to the State of California to cause cancer and birth defects and other reproductive harm.**

**Examples Include:**

- **Engine and generator exhaust**
- **Engine and generator fuel, and other liquids such as coolants and oil, especially used motor oil**
- **Cooking fuels**
- **Cleaners, paints, and substances used for vessel repair**
- **Waste materials that result from wear of vessel components**
- **Lead from battery terminals and from other sources such as ballast or fishing sinkers**

**To Avoid Harm:**

- **Keep away from engine, generator, and cooking fuel exhaust fumes.**
- **Wash exposed skin thoroughly with soap and water after handling the substances above.**

- Your boat's mechanical and electrical systems were designed to meet safety standards in effect at the time it was built.
- Some of these standards were mandated by law, and all of them were designed to insure your safety and the safety of other people, vessels and property.

Read this *supplement*, the *Cruiser & Yacht Owner's Manual*, and ***all*** accessory instructions for important safety standards and hazard information.

## Special Care for Moored Boats

### NOTICE

- To help seal the hull bottom and reduce the chance of gelcoat blistering while your boat is moored, apply an epoxy barrier coating.
- Cover the barrier coating with several coats of anti-fouling paint.
- Many states regulate the chemical content of bottom paints in order to meet environmental standards. Check with your local dealer about recommended bottom paints, and about the laws in effect in your area.

- Whether moored in saltwater or freshwater, your boat will collect marine growth on its hull bottom.
- This will detract from your boat's beauty, greatly affect its performance, and may damage the gelcoat.
- There are two methods of slowing marine growth:
  1. Periodically haul your boat out of the water and scrub the hull bottom with a bristle brush and a solution of soap and water.
  2. Occasionally re-paint the hull below the waterline with a good grade of anti-fouling paint.

### Sacrificial Anode (Zinc)

### NOTICE

- Do **NOT** paint between the zinc and the metal surface it contacts and do **NOT** paint over the zinc.
- If the zinc is **NOT** bonded correctly, it will **NOT** provide protection.

Your boat is equipped with a sacrificial anode (zinc) to protect underwater metal parts from excessive deterioration. Check the zinc regularly and replace it if it has deteriorated more than 70%.

Many factors affect the rate at which the zinc deteriorates, including:

- Water temperature
- Salinity
- Water pollution
- Stray electrical current

Stray electrical current from your boat, another boat, or the dock may cause complete deterioration of the zinc in just a few weeks. If there is rapid zinc deterioration, measure the electrolytic corrosion around your boat with a corrosion test meter.

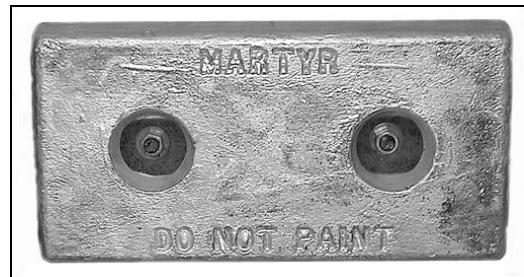

NEW SACRIFICIAL ANODE

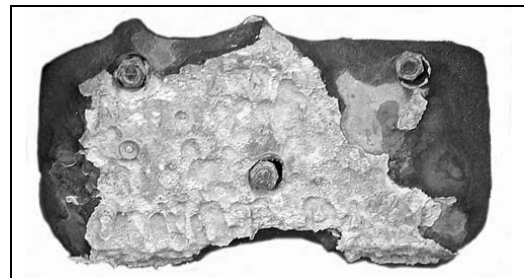

DETERIORATED SACRIFICIAL ANODE

## Boat Lifting



### WARNING!

**PERSONAL INJURY and/or PRODUCT or PROPERTY DAMAGE HAZARD!**

- Lifting slings can slip on the hull, which could cause serious injury or death.
- Reduce the risk of sling slippage by **ALWAYS** securing the lifting slings together **BEFORE** lifting.



### WARNING!

**PERSONAL INJURY and/or PRODUCT or PROPERTY DAMAGE HAZARD!**

**NEVER** lift any boat using the cleats, or the bow and stern eyes.



### WARNING!

**PERSONAL INJURY and/or PRODUCT or PROPERTY DAMAGE HAZARD!**

- Water in the bilge can shift and change the balance of the load.
- If water is present in the bilge, pump or drain the water out of the bilge areas **BEFORE** lifting your boat.



### CAUTION

**PRODUCT or PROPERTY DAMAGE HAZARD!**

When lifting any boat, **ALWAYS** use a spreader bar. The spreader bar **MUST** be equal to the width of your boat at each lifting point.

- **Always** follow the lift equipment's instructions and requirements.
- When lifting your boat, **always** position the lifting slings at the port and starboard lifting sling label positions as shown in the illustration.

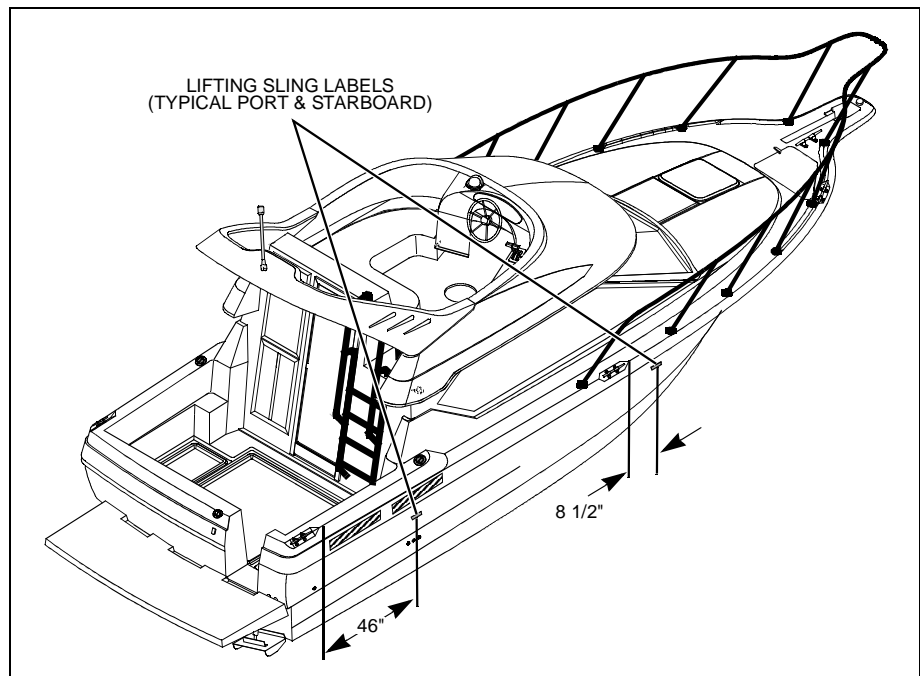

## Carbon Monoxide (CO)

<b>⚠ DANGER!</b>	
	<ul style="list-style-type: none"> <li>• Carbon monoxide gas (CO) is colorless, odorless, tasteless, and extremely dangerous.</li> <li>• <i>ALL</i> engines, generators, and fuel burning appliances produce CO as exhaust.</li> <li>• Prolonged exposure to low concentrations or very quick exposure to high concentrations <i>WILL</i> cause <i>BRAIN DAMAGE</i> or <i>DEATH</i>.</li> <li>• Teak surfing, dragging, or water skiing within 20 feet of a moving watercraft can be fatal.</li> </ul>

### **CO Facts**

- CO poisoning causes a significant number of boating deaths each year.
- Called the "silent killer", CO is an extremely toxic, colorless, odorless and tasteless gas.
- CO can harm or even kill you inside or outside your boat.
- CO can affect you whether you're underway, moored, or anchored.
- CO symptoms are similar to seasickness or alcohol intoxication.
- CO can make you sick in seconds. In high enough concentrations, even a few breaths can be fatal.
- Breathing CO blocks the ability of your blood to carry oxygen.
- The effects are cumulative. Even low levels of exposure can result in injury or death.

### **Factors that Increase the Effects of CO Poisoning**

- Age
- Smokers or people exposed to high concentrations of cigarette smoke
- Consumption of alcohol
- Lung disorders
- Heart problems
- Pregnancy

### Where & How CO Can Accumulate

Stationary conditions that increase CO accumulations include:

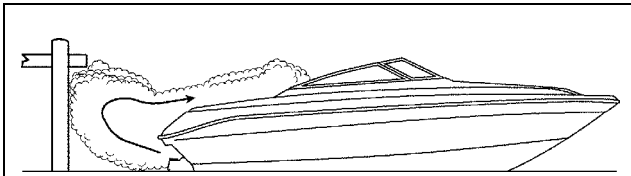

**A.** Using engine, generator, or other fuel burning device when boat is moored in a confined space.

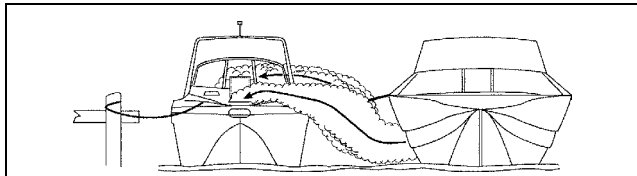

**B.** Mooring too close to another boat that is using its engine, generator, or other fuel burning device.

To correct stationary situations A and/or B:

- **Close all** windows, portlights and hatches.
- If possible, move your boat away from source of CO.

Running conditions that increase CO accumulations include:

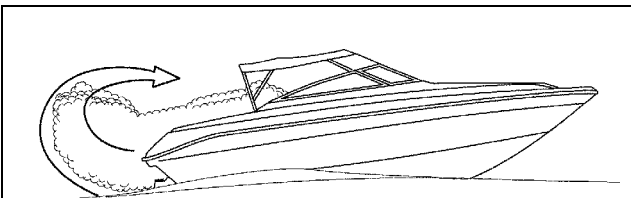

**C.** Running boat with trim angle of bow too high.

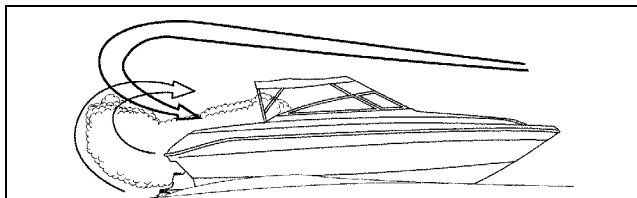

**D.** Running boat without through ventilation (station wagon effect).

To correct running situations C and/or D:

- Trim bow down.
- **Open** windows and canvas.
- When possible, run boat so that prevailing winds help dissipate exhaust.

### How to Protect Yourself & Others From CO

- Know where and how CO may accumulate in and around your boat (see above).
- **Always** maintain fresh air circulation throughout your boat.
- Know where your engine and generator exhaust outlets are located and keep everyone away from these areas.
- **Never** sit on, or hang onto, the back deck or swim platform while the engine(s) is running.
- **Never** enter the areas under swim platforms where exhaust outlets are located.
- Although CO can be present without the smell of exhaust fumes, if exhaust fumes are detected on your boat, take **immediate** action to dissipate these fumes.
- Treat symptoms of seasickness as possible CO poisoning. Get the person into fresh air **immediately**. Seek medical attention—unless you're sure it's **not** CO.
- Install and maintain CO monitors inside your boat. **Never** ignore any alarm. Replace monitors as recommended by the monitor manufacturer.
- Follow the checklists provided on the next page.
- Get a Vessel Safety Check.

For information on how to get a free VESSEL SAFETY CHECK, visit [www.vesselsafetycheck.org](http://www.vesselsafetycheck.org) or contact your local U.S. Coast Guard Auxiliary or United States Power Squadrons®.

- U.S. Coast Guard Auxiliary: 1-800-368-5647 or on the Internet at: <http://www.cgaux.org>
- U.S. Power Squadrons: 1-888-FOR-USPS (1-888-367-8777) or on the Internet at: <http://www.usps.org>

## CO Checklists

### Trip Checklist

- Make sure you know where the exhaust outlets are located on your boat.
- Educate *all* passengers about the symptoms of CO poisoning and where CO may accumulate.
- When docked, or rafted with another boat, be aware of exhaust emissions from the other boat.
- Listen for any change in exhaust sound, which could mean an exhaust component failure.
- Test the operation of each CO monitor by pressing the test button.

### Monthly Checklist

- Make sure *all* exhaust clamps are in place and secure.
- Look for exhaust leaking from exhaust system components. Signs include rust and/or black streaking, water leaks, or corroded or cracked fittings.
- Inspect rubber exhaust hoses for burned, cracked, or deteriorated sections. *All* rubber hoses should be pliable and free of kinks.

### Annual Checklist

#### **Have a Qualified Marine Technician:**

- Replace exhaust hoses if cracking, charring, or deterioration is found.
- Ensure that your engines and generators are properly tuned, and well maintained.
- Inspect each water pump impeller and the water pump housing. Replace if worn. Make sure cooling systems are in working condition.
- Inspect *all* metallic exhaust components for cracking, rusting, leaking, or loosening. Make sure they check the cylinder head gasket, exhaust manifold, water injection elbow, and the threaded adapter nipple between the manifold and the elbow.
- Clean, inspect, and confirm proper operation of the generator cooling water anti-siphon valve (if equipped).

## CO Monitors

### NOTICE

- **The stereo memory and CO monitors place a small, but constant drain on the battery.**
- **If your boat will be unattended for an extended amount of time, plug into shore power with the battery charger turned *On*.**

- Do *not* disconnect the CO monitors.
- Read the manufacturer's instructions for your CO monitor. **If you did not get the manufacturer's instructions, call (800) 383-0269 and they will be mailed to you.**

If your boat is *not* equipped with a CO monitor, consider purchasing one from your dealer or marine supply store.

**More Information**

For more information about how you can prevent carbon monoxide poisoning on recreational boats and other ways to boat more safely, contact:

United States Coast Guard  
Office of Boating Safety (G-OPB-3)  
2100 Second Street SW  
Washington, DC 20593  
www.uscgboating.org  
1-800-368-5647

National Marine Manufacturers  
Association (NMMA)  
200 East Randolph Drive  
Suite 5100  
Chicago, IL 60601-9301  
www.nmma.org  
312-946-6200

American Boat & Yacht Council, Inc.  
(ABYC)  
3069 Solomon's Island Road  
Edgewater, MD 21037-1416  
www.abycinc.org  
410-956-1050

For information on how to get a free VESSEL SAFETY CHECK, visit [www.vesselsafetycheck.org](http://www.vesselsafetycheck.org) or contact your local U.S. Coast Guard Auxiliary or United States Power Squadrons®.

- U.S. Coast Guard Auxiliary: 1-800-368-5647 or on the Internet at: <http://www.cgaux.org>
- U.S. Power Squadrons: 1-888-FOR-USPS (1-888-367-8777) or on the Internet at: <http://www.usps.org>



## Chapter 2: Locations

### Exterior Views

#### Hull Views

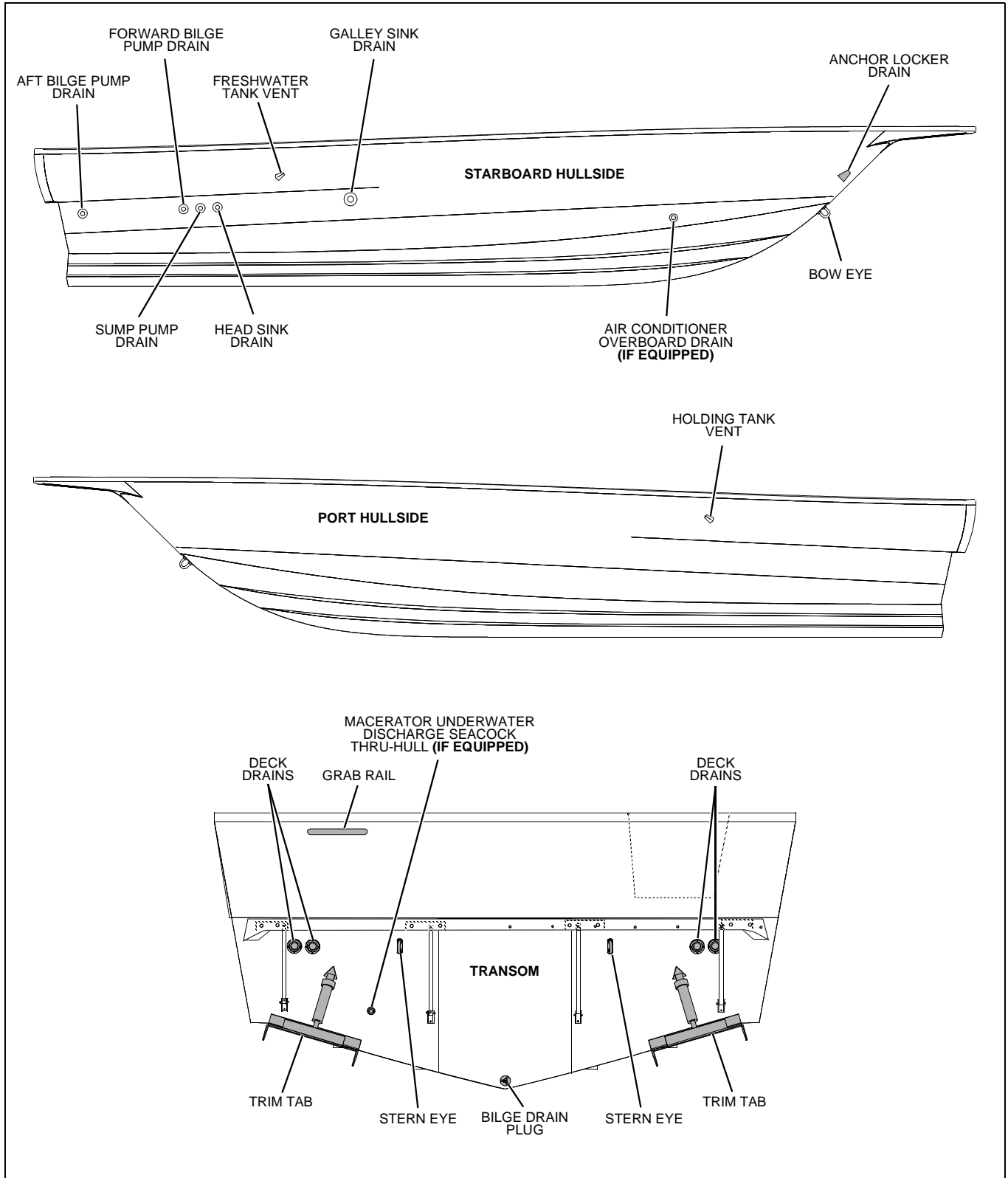

**Deck View**

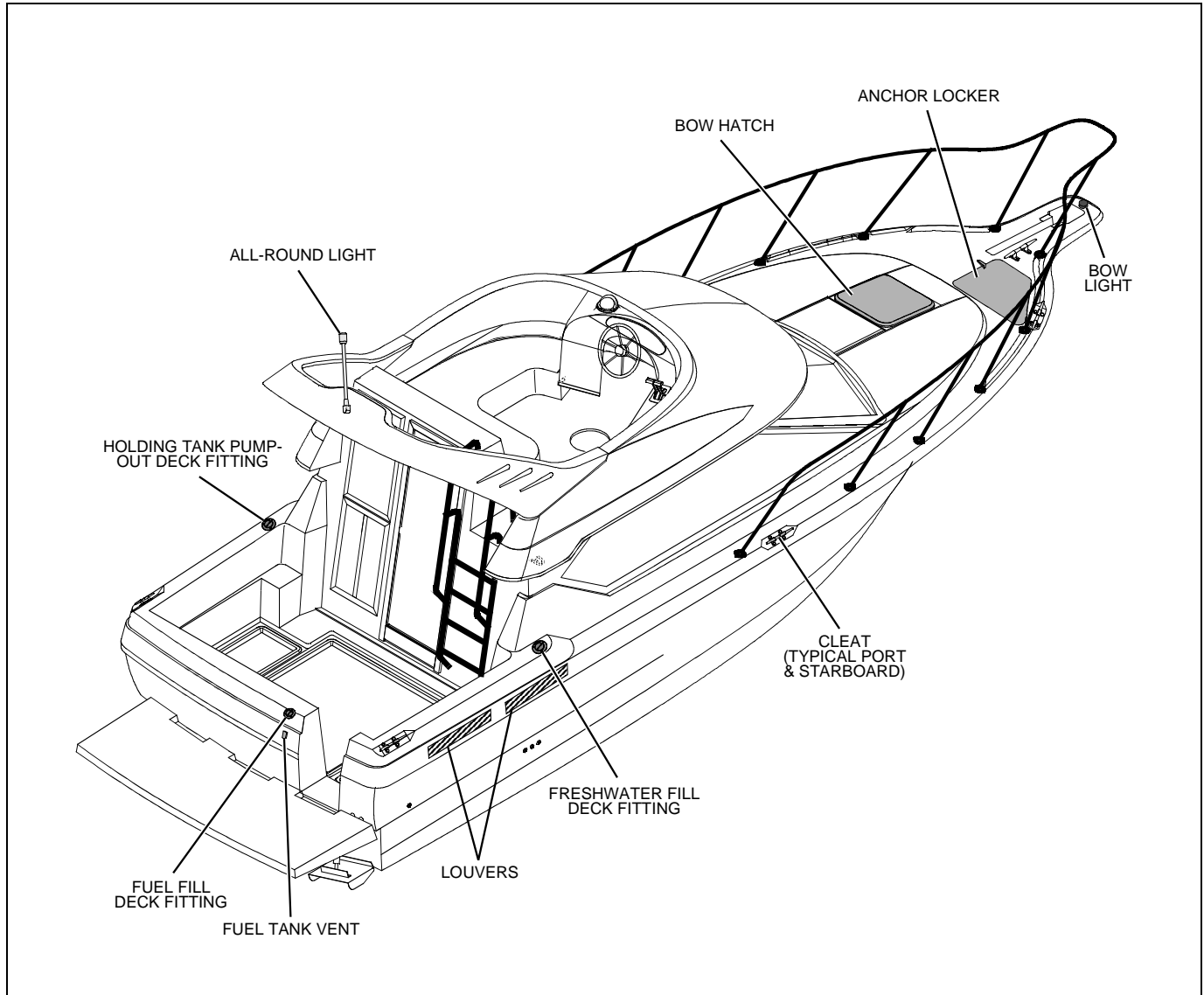

### Helm

**NOTE: TYPICAL HELM LAYOUT SHOWN. ACTUAL LAYOUT MAY VARY DEPENDING ON ENGINE AND ACCESSORY OPTIONS.**

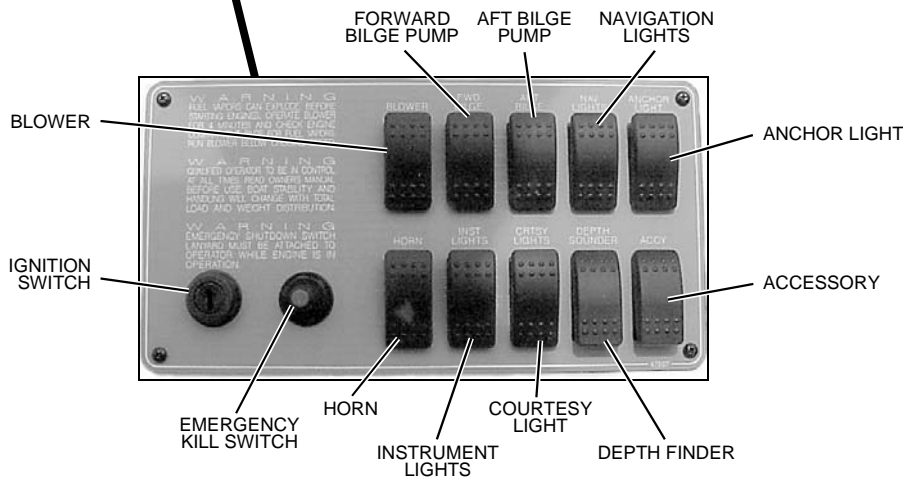
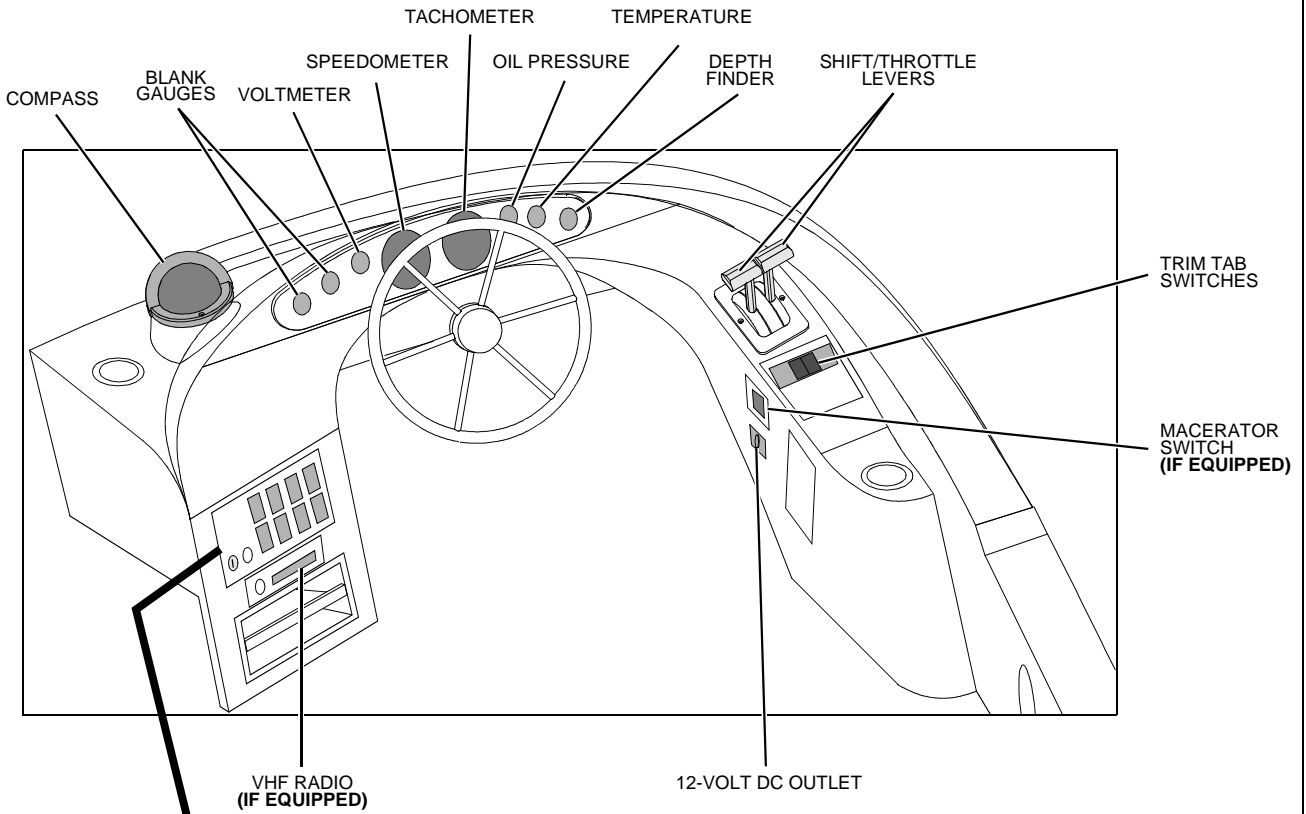

## Component Locations

### 12-Volt DC Accessory Outlets (2 Total):

- One is located at the helm, below the shift/throttle levers.

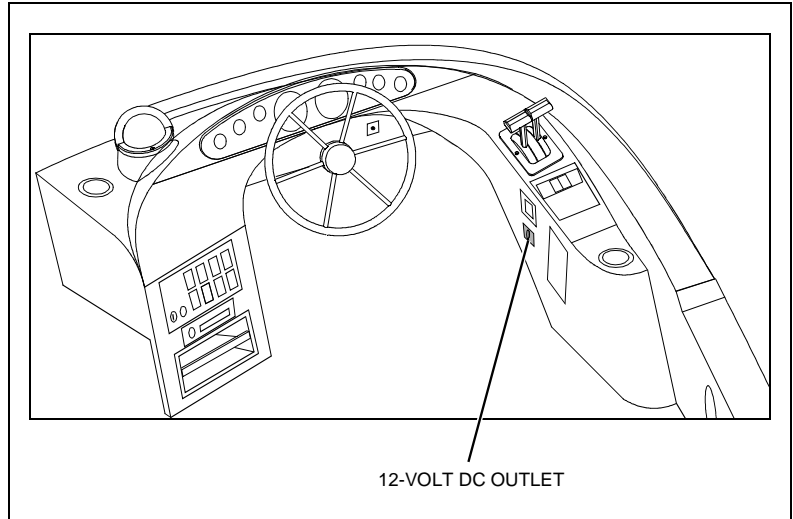

- One is located above the refrigerator in the galley.

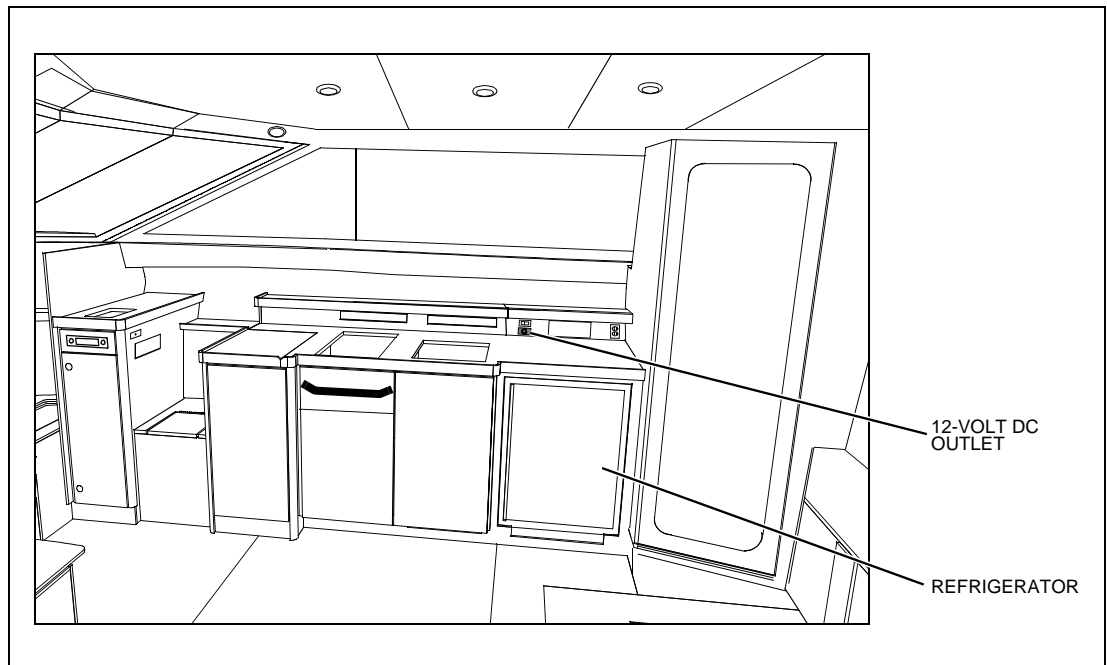

**12-Volt DC Push-To-Reset Circuit Breakers:** Located under the command bridge helm.

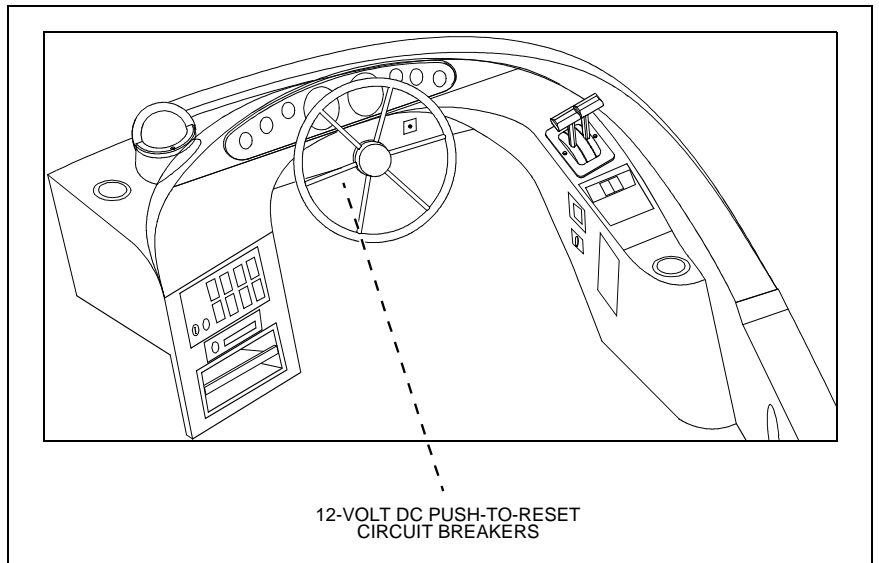

**110-Volt AC Master Panel:** Located above the refrigerator in the galley.

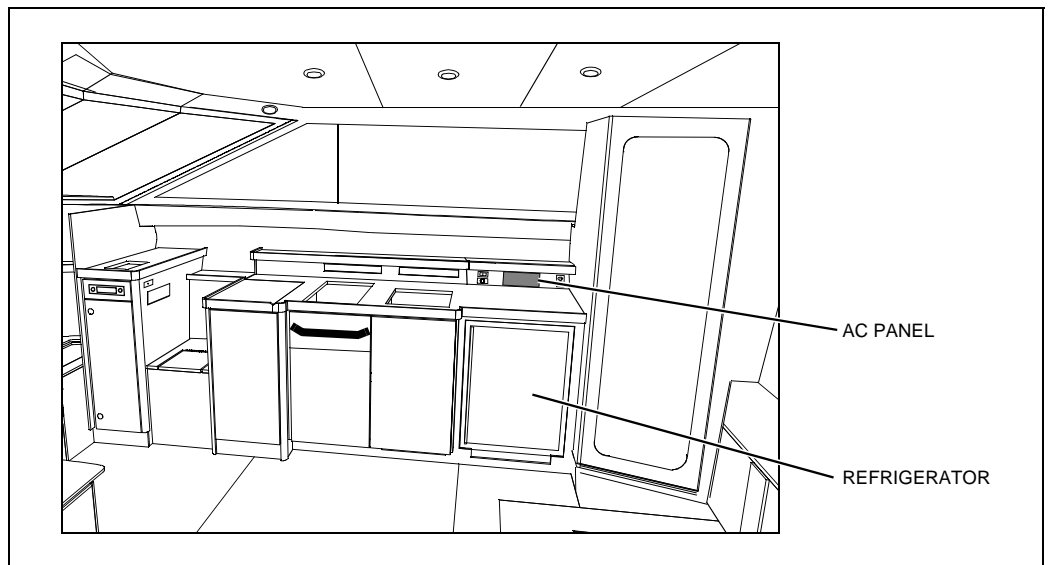

**Air Conditioner (If Equipped):** Located in the aft center storage locker under the v-berth mattress.

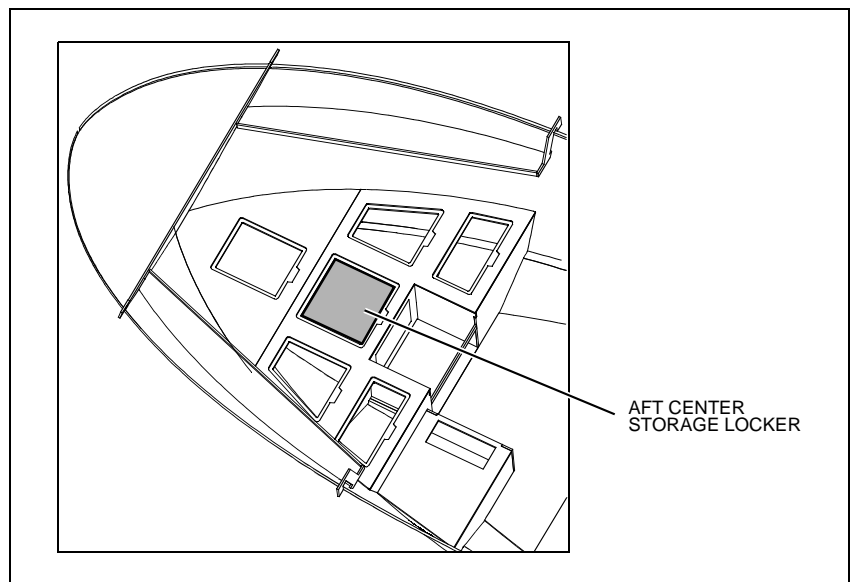

**Air Conditioner Seawater Intake Seacock (If Equipped):** Located in the engine room bilge.

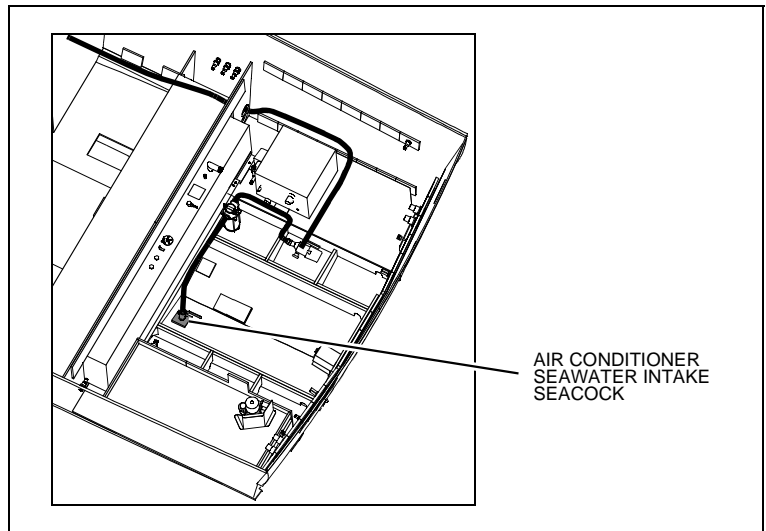

**Batteries:** Located in the port forward corner of the engine room.

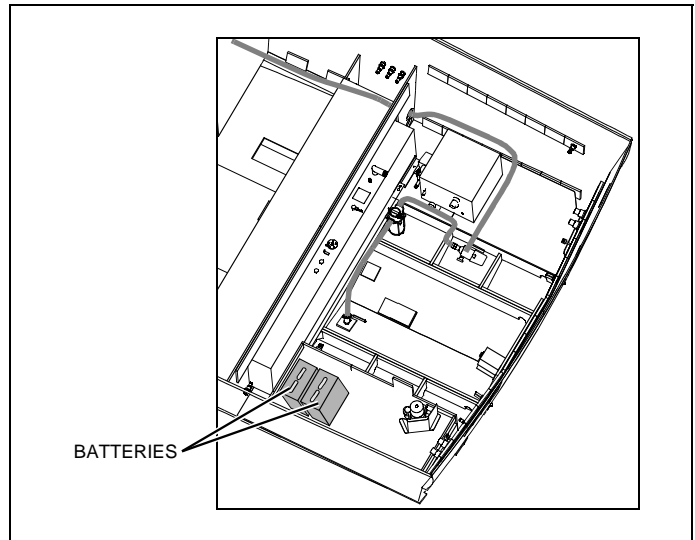

**Battery Charger:** Located on the port side of the engine room, on the aft wall.

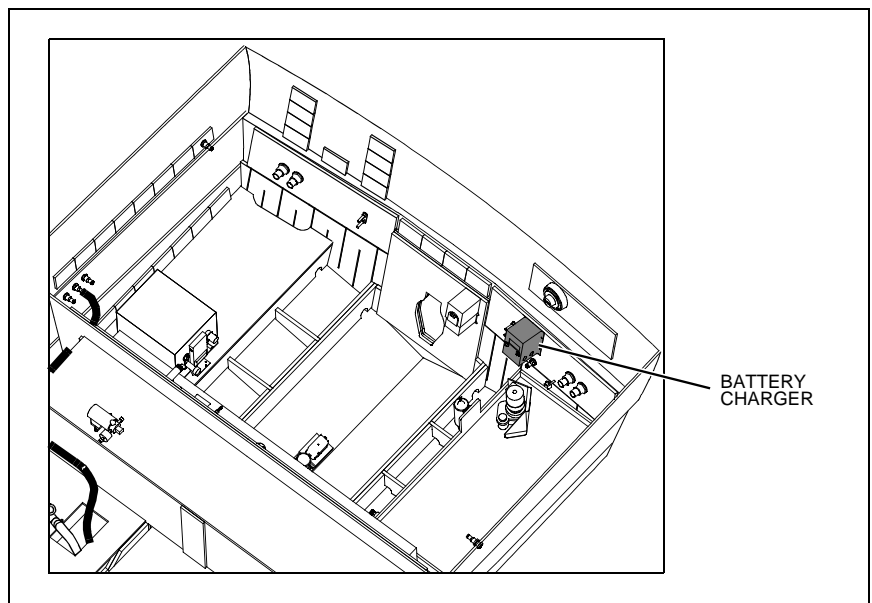

**Battery Switch:** Located inside the cockpit storage hatch.

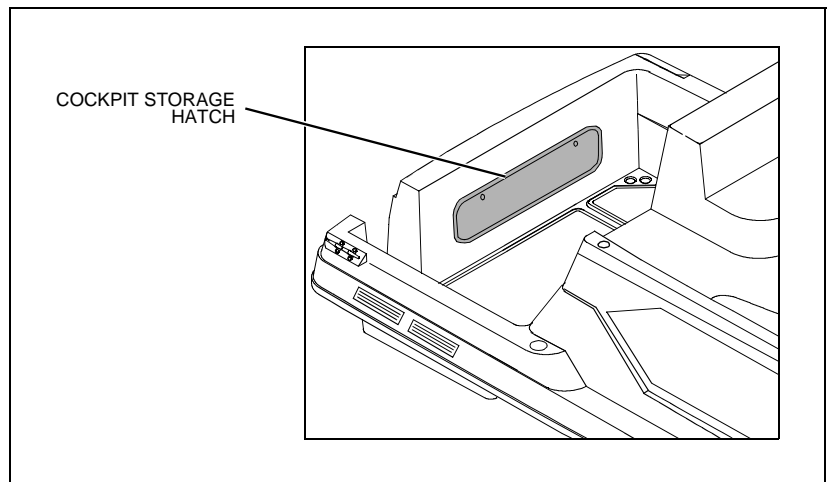

**Bilge Pumps (2 Total):**

- One is located in the engine room bilge.
- One is accessed through the floor hatch in front of the entry step.

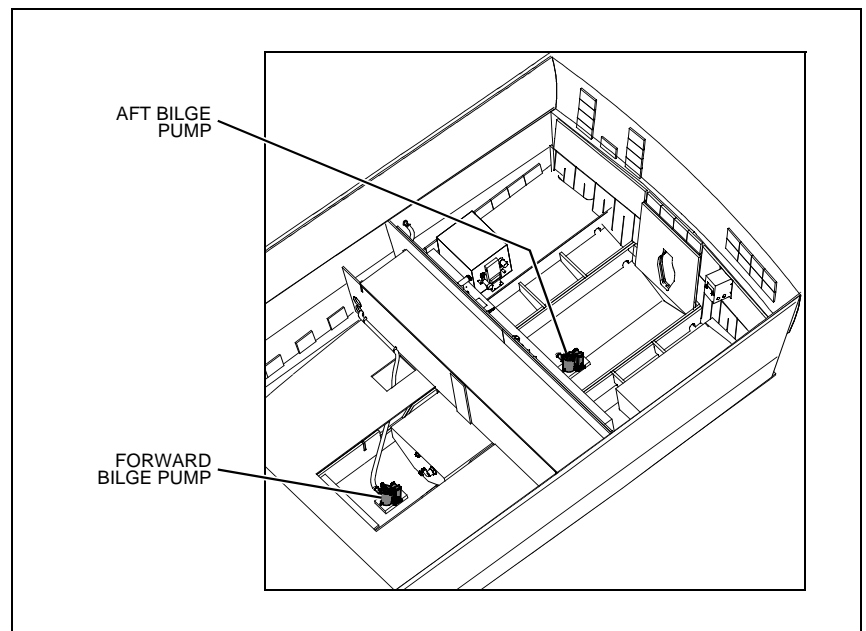

**Blower Switch:** Located on the helm switch panel.

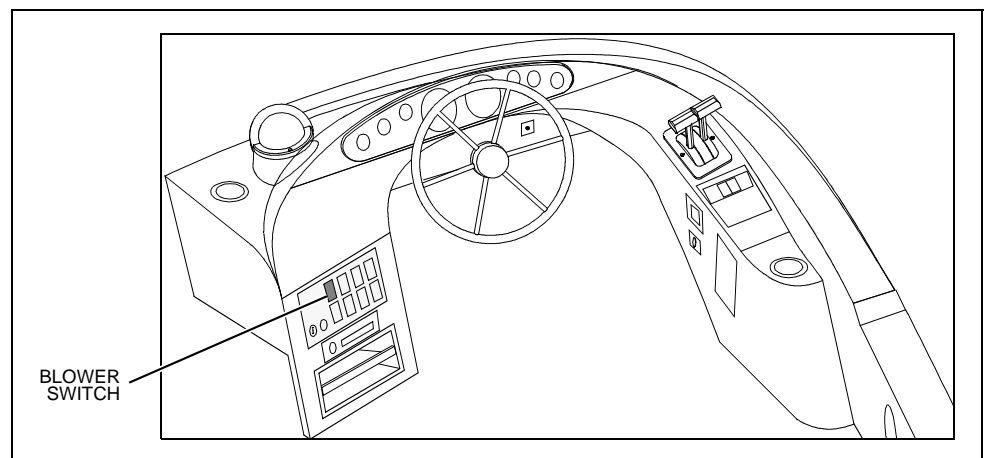

**CO Monitors (2 Total):**

- One is located in the aft berth on the port wall.

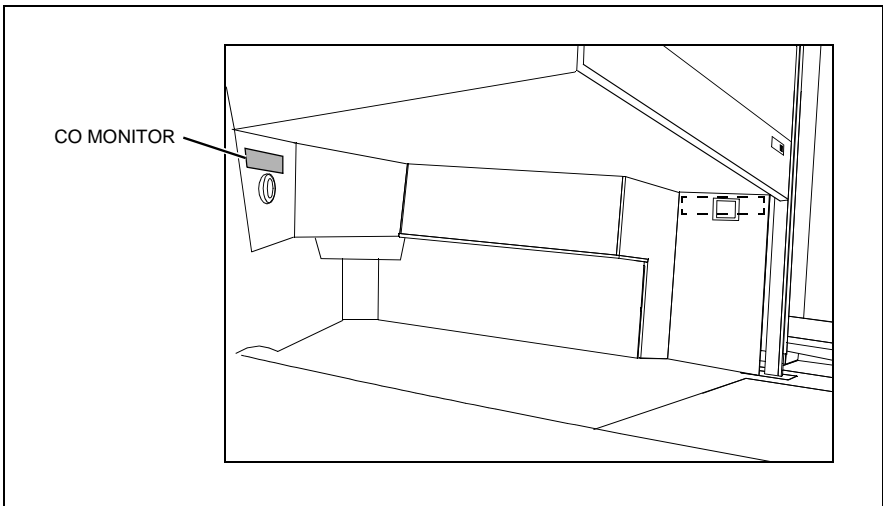

- One is located in the starboard aft corner of the v-berth.

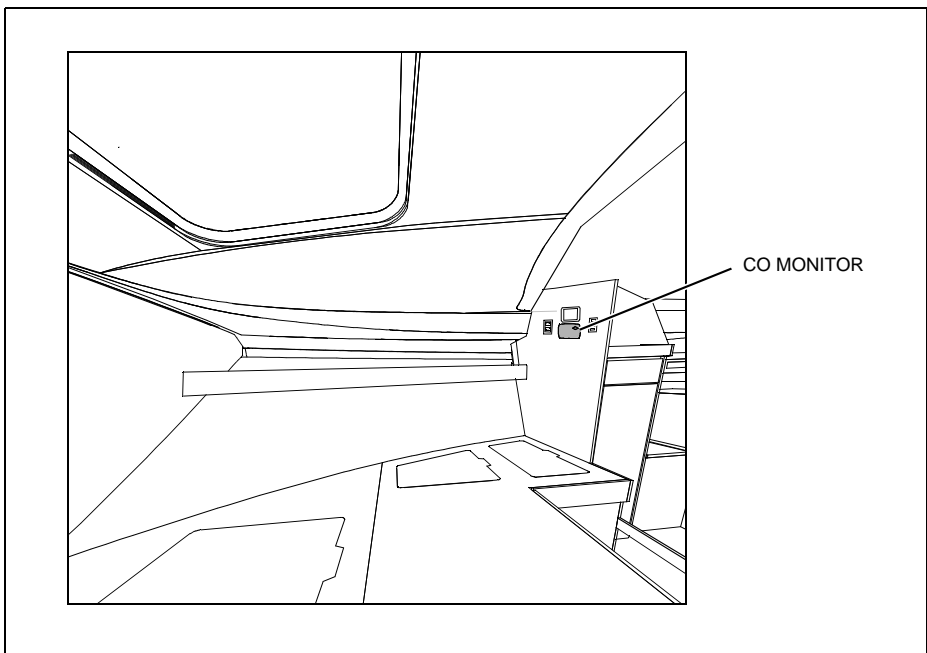



**Depth Finder Transducer:** Located in the engine room bilge, forward of the bilge pump.

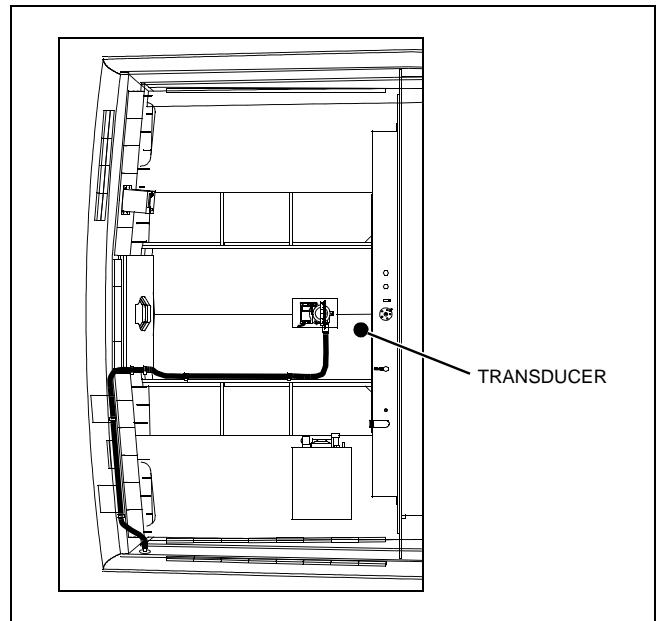

**Freshwater Fill Deck Fitting (marked WATER):** Located on the starboard deck.

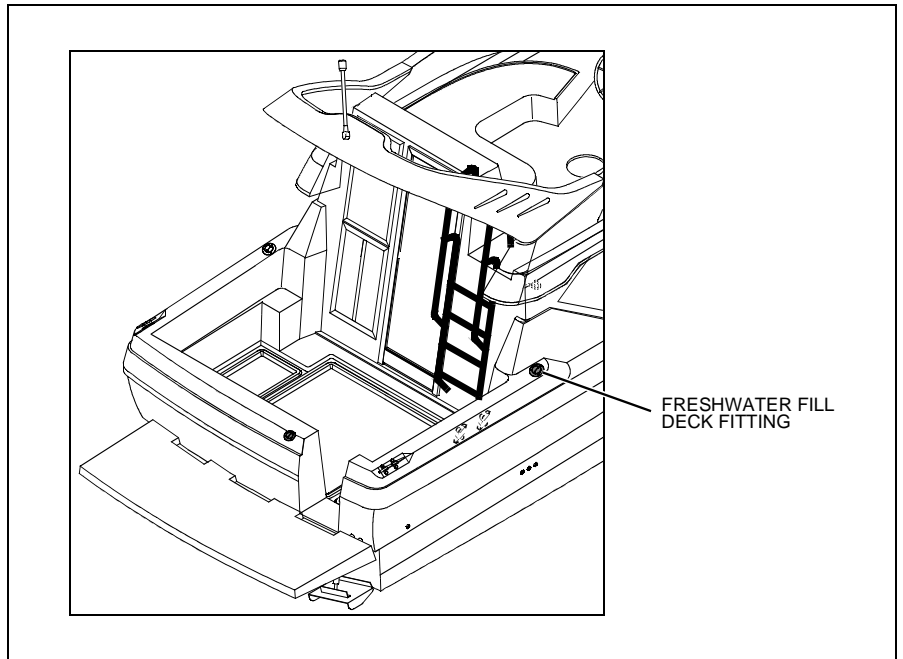

**Freshwater Pump:** Access through the starboard wall cut-out next to the head door.

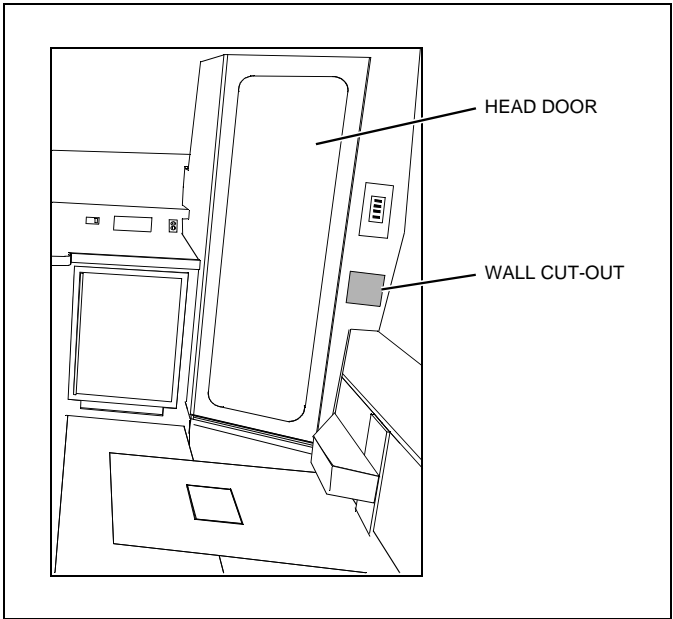

**Freshwater Pump Switch:** Located in the galley, above the refrigerator.

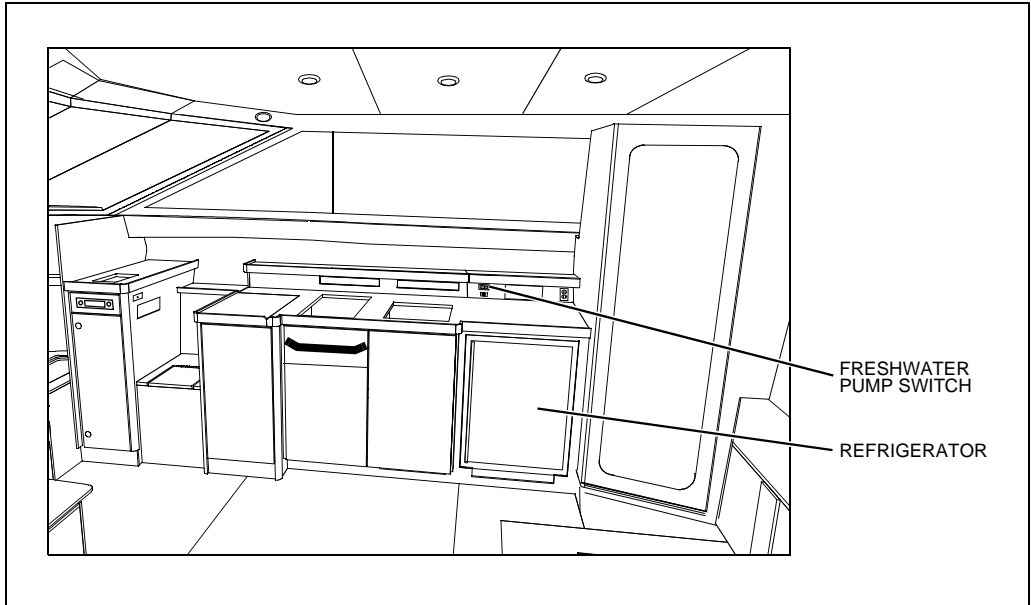

**Freshwater Tank:** Access through the floor hatch in front of the entry step.

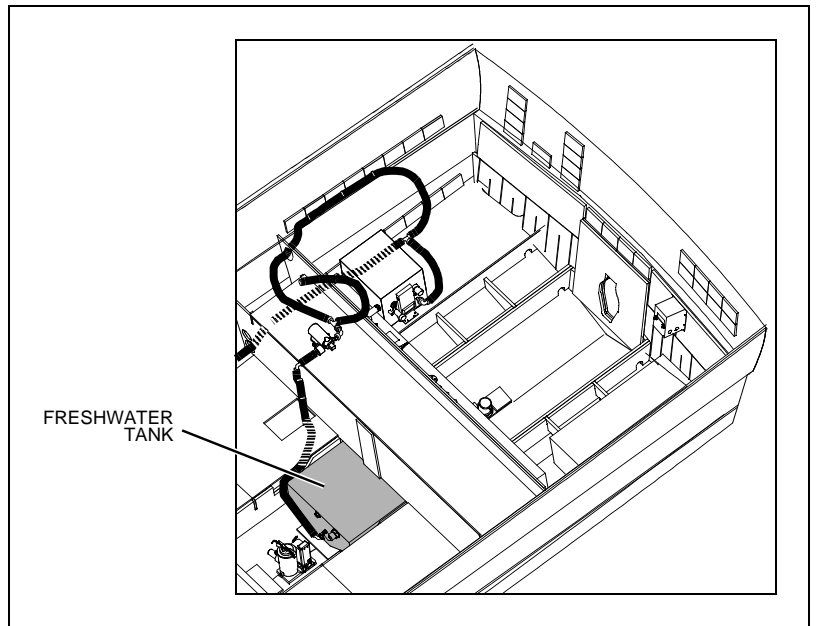

**Fuel Fill Deck Fitting (marked GAS or DIESEL):** Located on the aft deck.

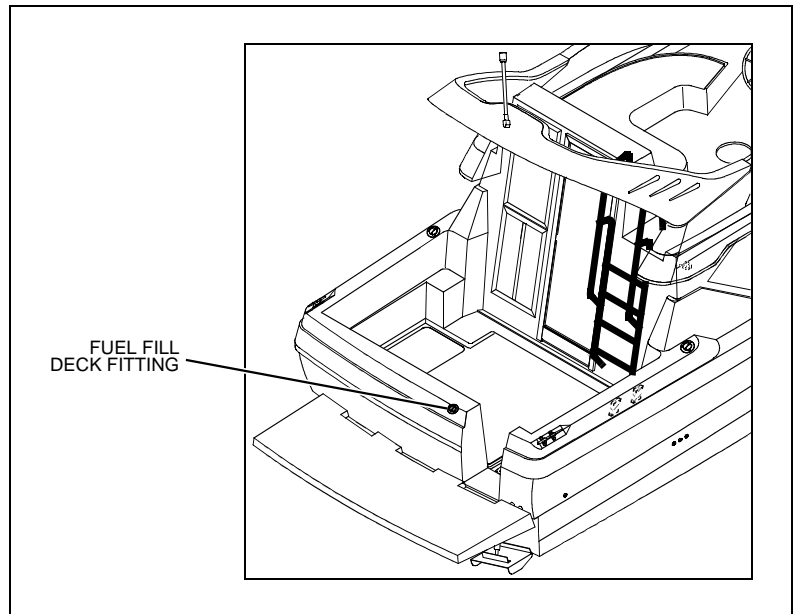

**Fuel Tank:** Located in the engine room.

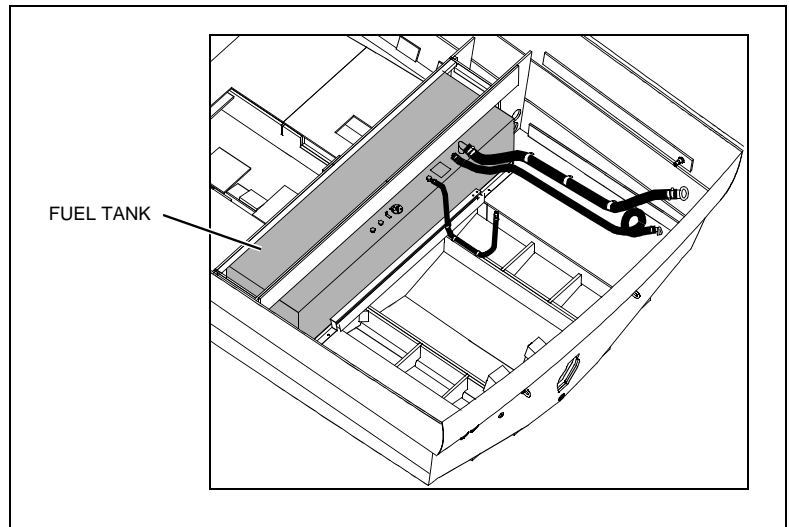

**Holding Tank:** Located on the port side of the engine room.

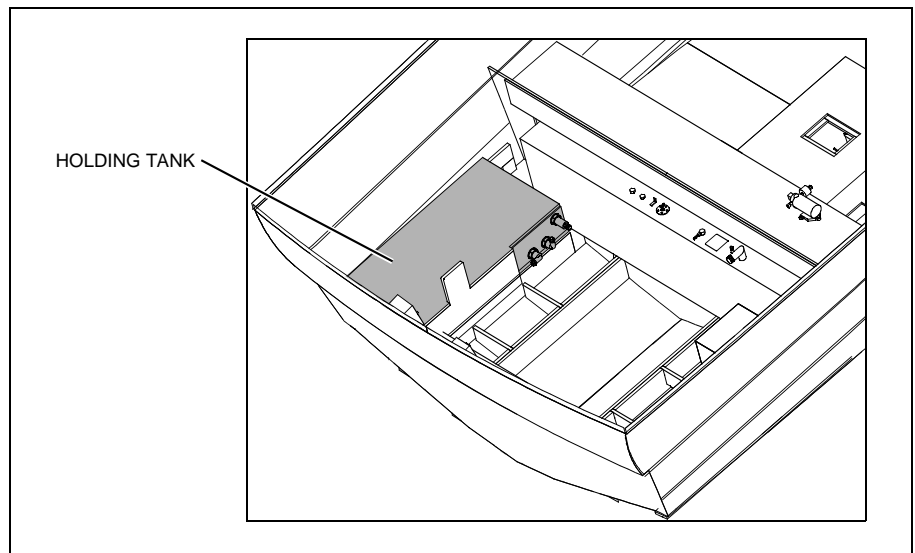

**Holding Tank Pump-out Deck Fitting (marked WASTE):** Located on the port deck.

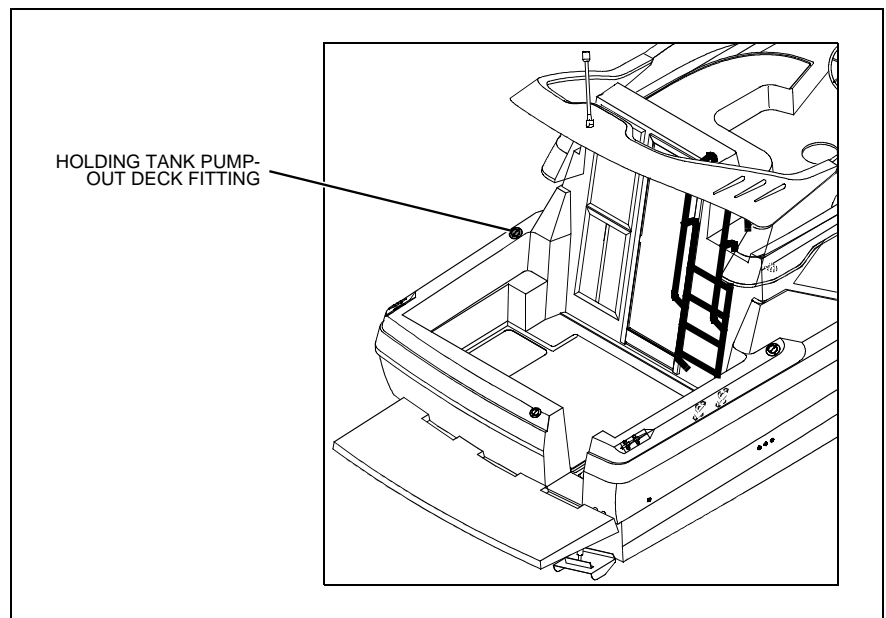

**Macerator Underwater Discharge Seacock (If Equipped):** Located in the aft engine room.

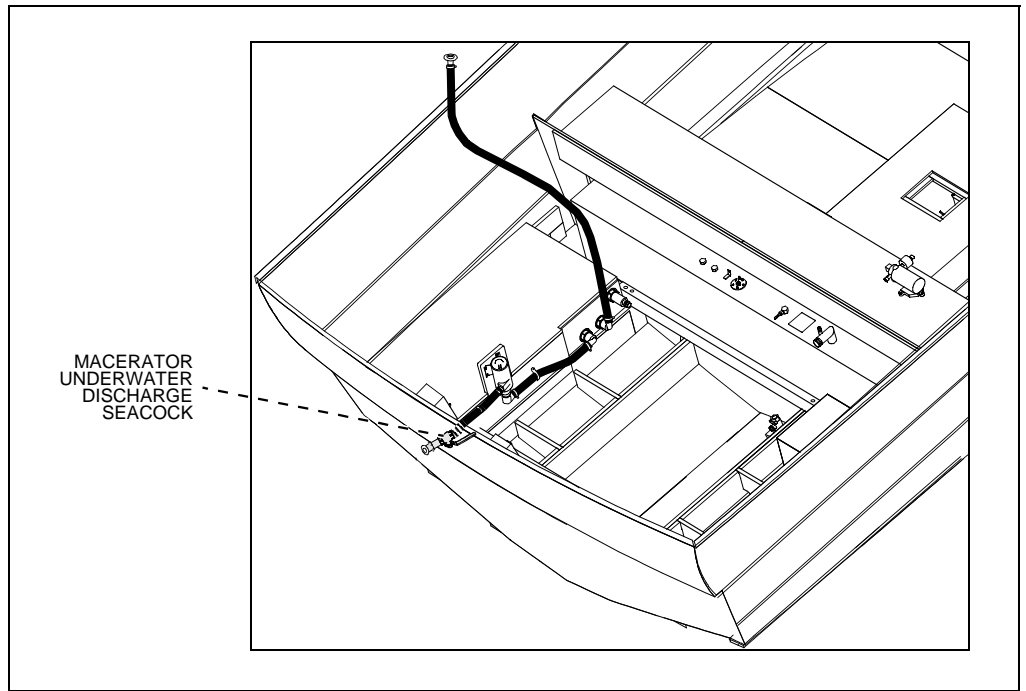

**Marine Head Seawater Intake Seacock:** Located in the engine room bilge.

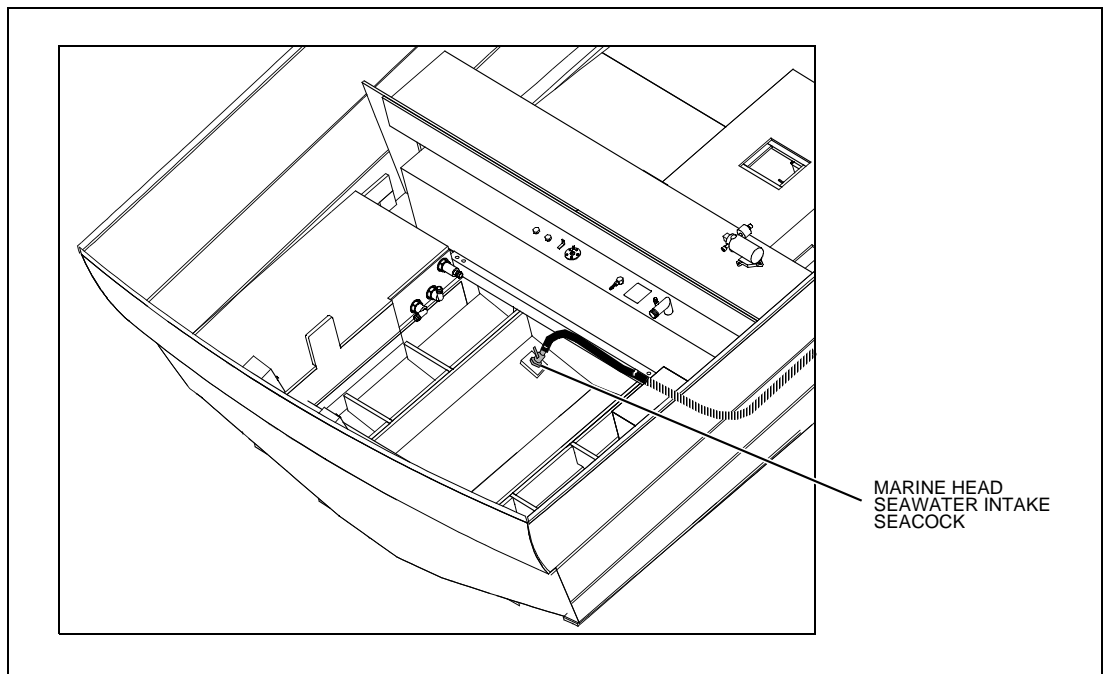

**Navigation Lights:**

- Red and green running light at the bow.
- White all-round light on the radar wing.

**Shore Power Inlet(s):** Located on the starboard side of the cockpit.

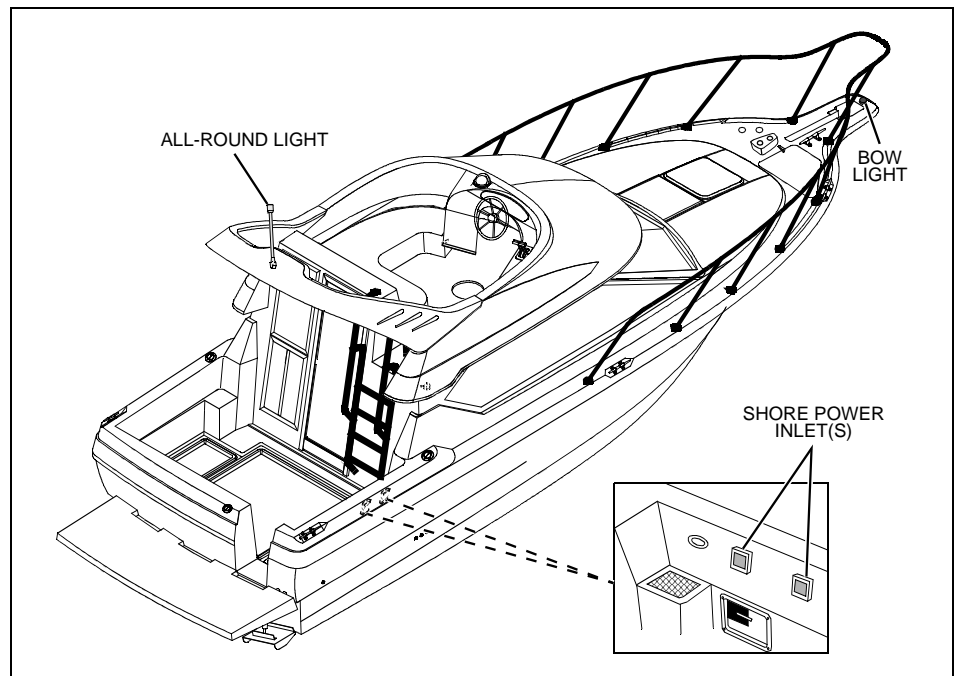

**Shower Drain Sump Box:** Access through the floor hatch in front of the entry step.

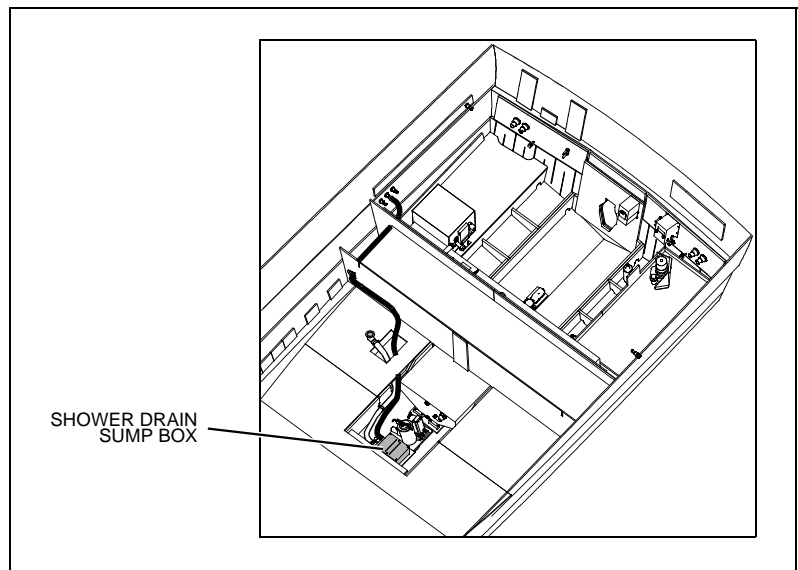

**Trim Tab Hydraulic Fluid Reservoir:** Located on the port side of the engine room on the aft wall.

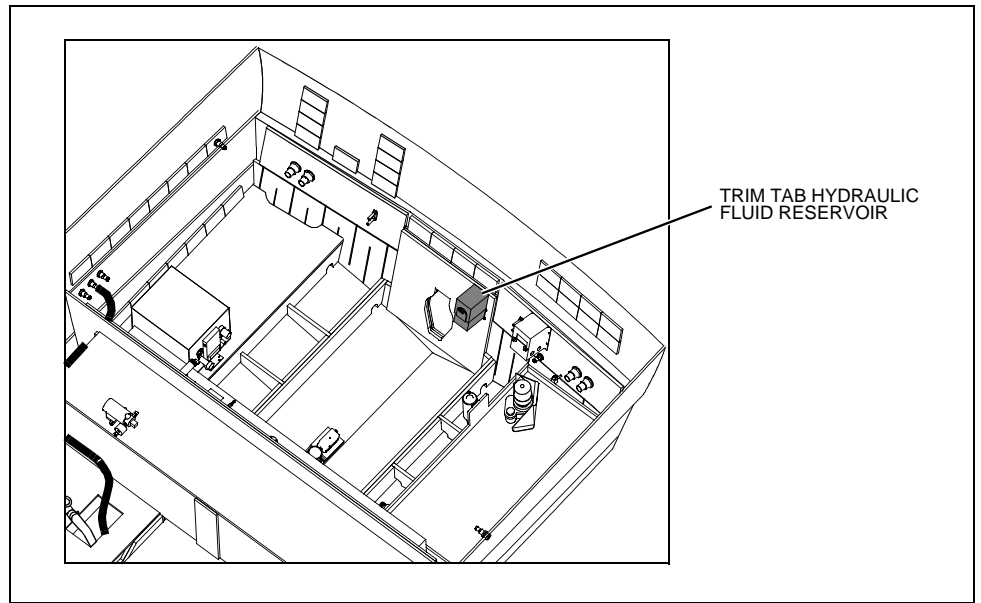

**Water Heater:** Located on the starboard side of the engine room.

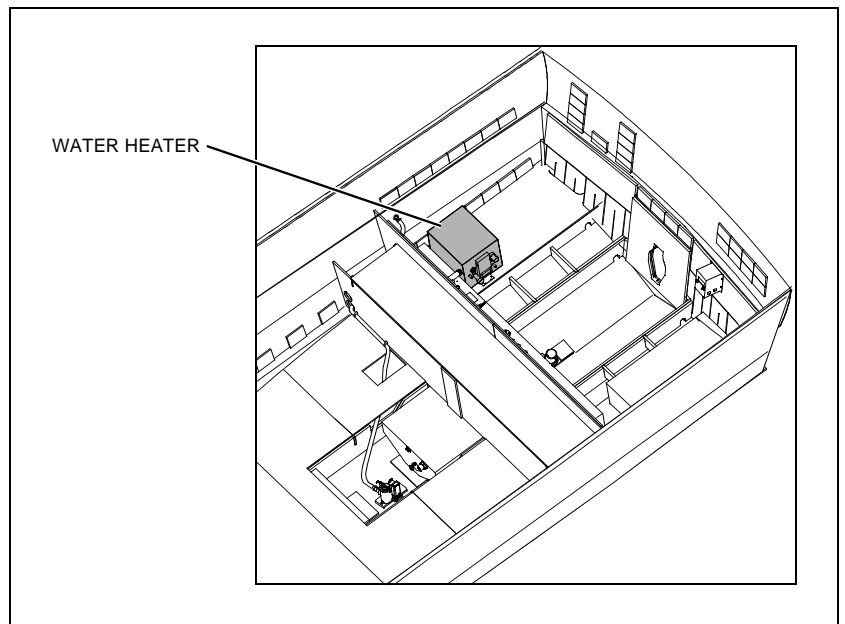

## Chapter 3: Propulsion & Related Systems

### Engine

Read the engine operation and maintenance manuals *before* starting or working on the engine.

### Diesel Engine Cooling System (If Equipped)

 <b>CAUTION</b>
<b>SYSTEM DAMAGE HAZARD!</b>
<ul style="list-style-type: none"> <li>• <i>Open</i> the engine cooling system's seacock or ball valve <b>BEFORE</b> starting the engine.</li> <li>• <b>Keep</b> the engine cooling system's seacock or ball valve <i>Open</i> while the engine is running.</li> </ul>

The diesel engine cooling system circulates seawater through the engine to reduce engine temperatures.

- **Open** the seawater intake ball valve *before* starting the engine.
- Keep the ball valve **Open** while the engine is running.
- Check the cooling system's seawater strainer for leaks and debris *every time* you use your boat.
- Read the seawater strainer instruction sheet for instructions about cleaning the seawater strainer.

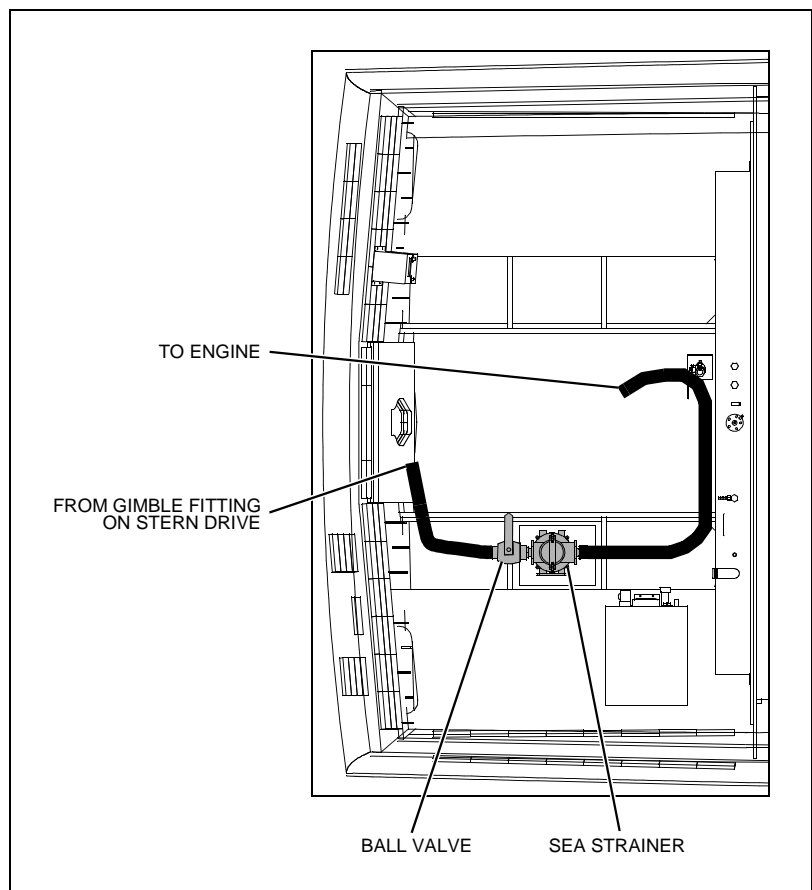



## Bilge Blower System

**! WARNING!**

**FIRE and EXPLOSION HAZARD!**

Fuel vapors can explode! **BEFORE** starting the engine:

1. Check the bilge areas for fuel vapors or leaking fuel. If you see leaking fuel or smell fuel vapors:
  - a. Do **NOT** start the engine, do **NOT** turn *On* any electrical devices, extinguish **ALL** cigarettes, cigars, and other sources of flame or ignition.
  - b. Get everyone off your boat.
  - c. Get trained help to find and fix the problem.
2. Run the bilge blower for at least four minutes prior to engine starting, electrical system maintenance, or activation of electrical devices.
  - If you smell fuel vapors and the engine is already running;
    - a. Shut *Off* the engine and turn *Off* **ALL** electrical devices.
    - b. Extinguish **ALL** cigarettes, cigars, and other sources of flame or ignition.
    - c. Get trained help to find and fix the problem.
  - **NEVER** obstruct or change the bilge blower system.

- The bilge blower system removes explosive fumes from the engine and bilge areas.
- Fresh air is drawn into the engine and bilge areas through the vents.

### To make sure the engine and bilge areas are properly ventilated:

- Use the "sniff test" to check the engine and bilge areas for fuel vapors *before* starting the engine.
- **Always** run the bilge blower for at least four minutes *before* starting the engine.
- Continue to run the blower until your boat has reached cruising speed.
- **Always** run the blower when running the boat below cruising speed.

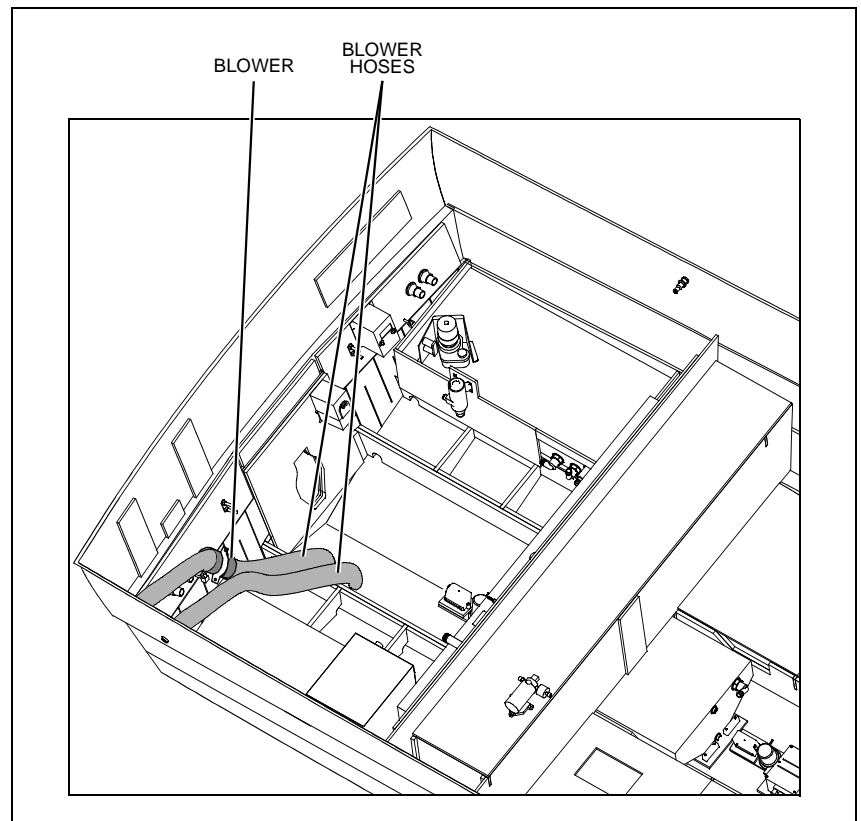

## Fuel System

⚠ **WARNING!**



**FIRE, EXPLOSION, and OPEN FLAME HAZARD!**

- It is very important that the fuel system be inspected thoroughly the first time it is filled and at each subsequent filling.
- The fueling instructions in the *Cruiser & Yacht Owner's Manual* and the fuel recommendations in the engine operation manual **MUST** be followed.

⚠ **CAUTION**

Avoid the storage or handling of gear near the fuel lines, fittings and tank.

### NOTICE

- On diesel engine models, air in the diesel supply system can stop an engine or severely restrict performance.
- If you suspect air in the fuel lines, refer to your engine operation manual for detailed instructions on how to bleed the system.

### NOTICE

Carefully read the fuel section of both the *Cruiser & Yacht Owner's Manual* and the engine operation manual, paying special attention to the subject of *fuel recommendations*.

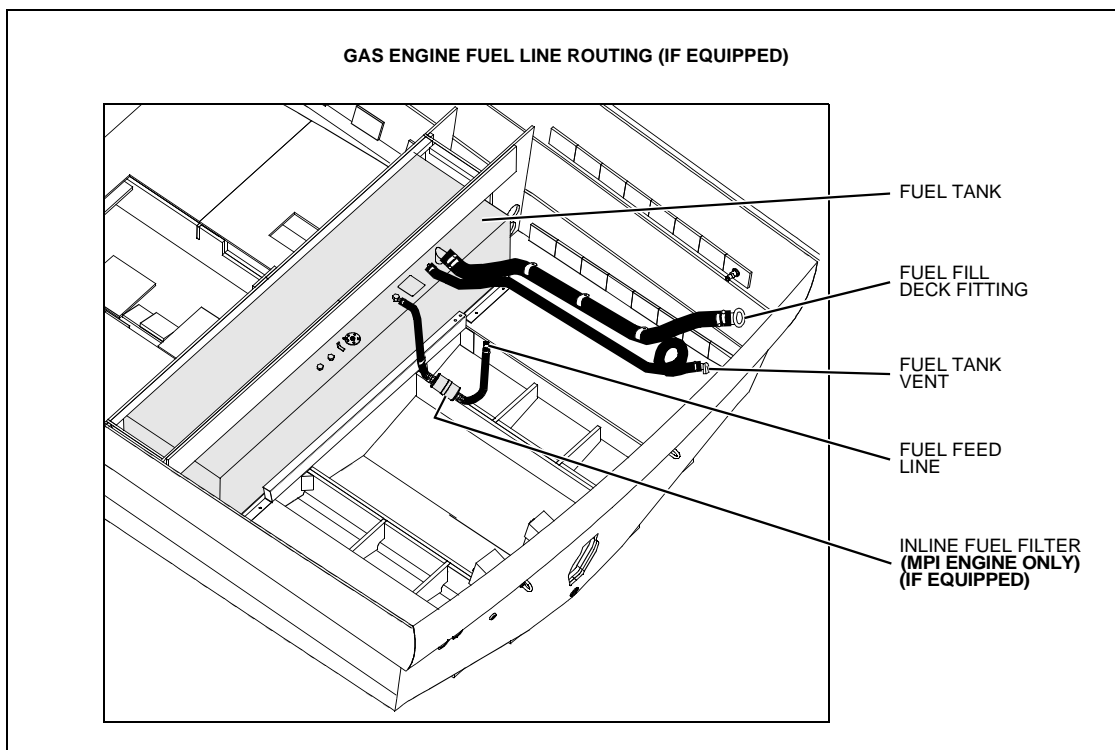

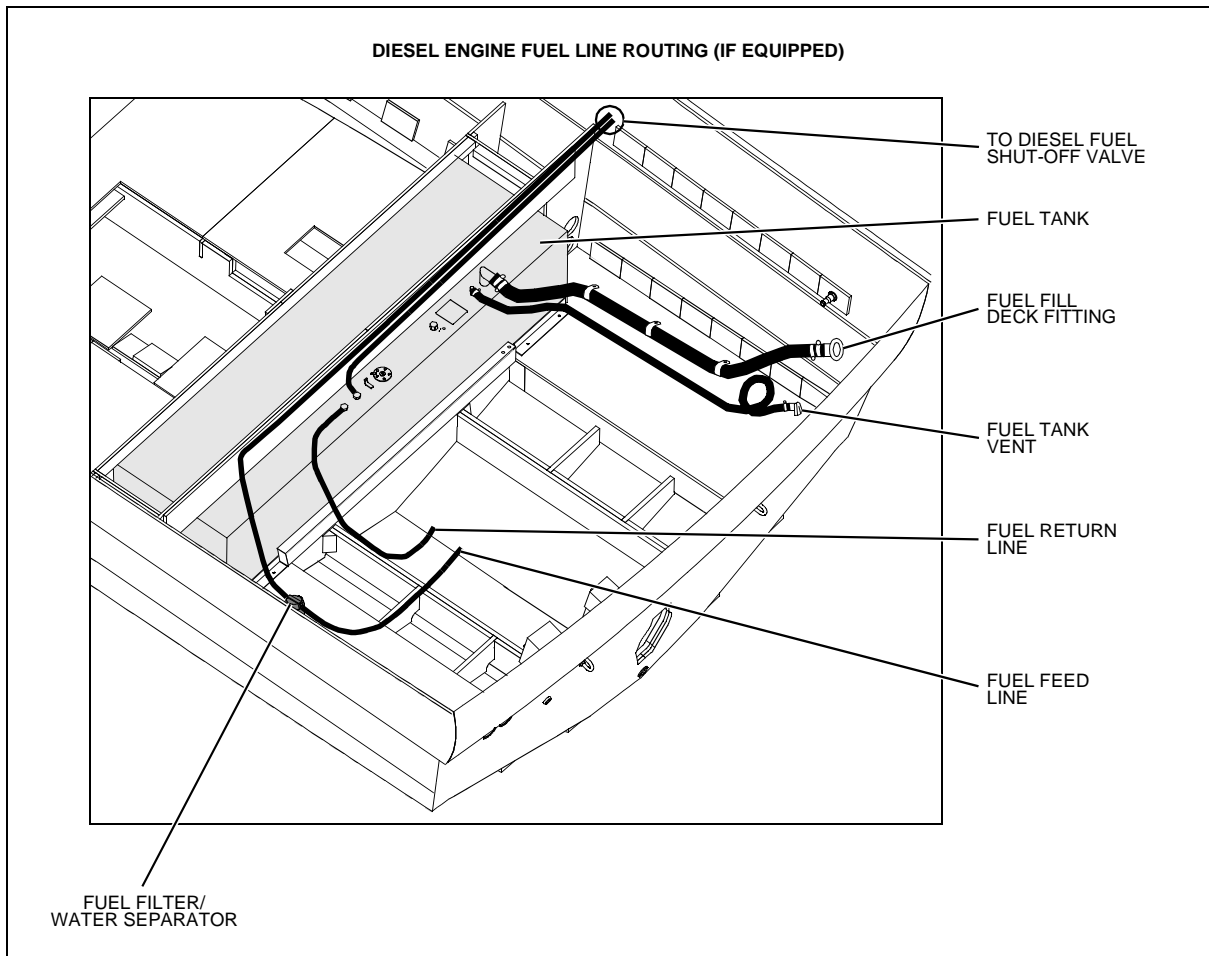

### **Fuel Fill & Vent**

- Depending on engine type, the fuel fill deck fitting is marked either GAS or DIESEL.
- If you have problems filling the fuel tank, see if the fuel fill hose or fuel tank vent hose is kinked or collapsed.
- If there are no visible signs of a problem, contact your local dealer.

### **Anti-siphon Valve (Gas Engine Only)**

#### **NOTICE**

- **If an engine running problem is diagnosed as fuel starvation, check the anti-siphon valve.**
- **If the valve is stuck or clogged, *ONLY* change or replace it while the engine is *Off*.**
- ***NEVER* run the engine with the anti-siphon valve removed, except in an emergency.**

- The anti-siphon valve is a vital fuel system part.
- If the fuel line ruptures, this valve will prevent the fuel from siphoning from the tank.
- The valve is located on the fuel tank, where the fuel feed line attaches to the tank.
- The valve is spring loaded and is opened by fuel pump vacuum.

### **Gas Engine Fuel Filters**

- The fuel pickup tube, located inside the fuel tank, is equipped with a fine mesh screen filter.
- If your boat features an MPI engine, there may be an inline fuel filter on the fuel line.
- Also, when supplied by the engine manufacturer, a fuel filter is installed on the engine.
- Periodically replace the fuel filters to make sure they remain clean and free of debris.
- Talk to your selling dealer or local marina about fuel additives that help prevent fungus or other buildup in your fuel tank.

### **Fuel Filter/Water Separator (Diesel Engine Only)**

#### **NOTICE**

- **The frequency of water draining or element replacement is controlled by the contamination level in the fuel.**
- **Inspect the collection bowls for water daily.**
- **Replace the elements at least once a year, or when a loss of power is noticed, whichever comes first.**

- The fuel feed line features a fuel filter/water separator.
- Service instructions for the fuel filter/water separator are provided on the filter.

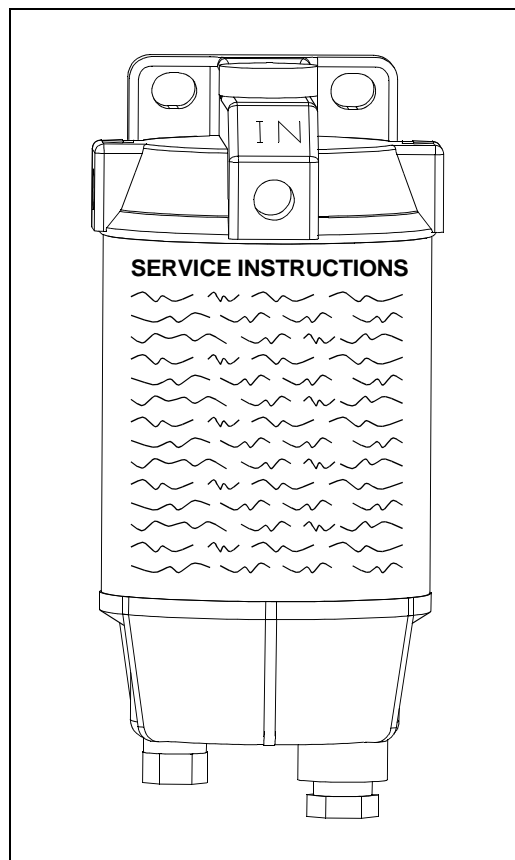

## Quick Oil Drain System

The quick oil drain hose was attached to the engine oil pan at the factory. However, some minor assembly is still needed *before* you can use this system.

### How to install the quick oil drain system:

1. Unscrew the factory installed bilge plug from the bilge drain (A). Keep the factory bilge plug on the boat as a spare.
2. Unclip the quick oil drain assembly from the wire loop (B) on the engine.
3. Un-clip the draw cord section (C) from the draw cord section (D).
4. Thread the draw cord section (D), the oil drain plug (E), and the oil drain hose (F) through the bilge drain (A).
5. **Adjust the hose stop clamp (G) so that no more than 12 inches of hose, including the oil drain plug, can extend out of the bilge drain (A).**
6. Re-clip the draw cord section (C) to the draw cord section (D).
7. Push the oil drain hose, oil drain plug, and both sections of the draw cords through the bilge drain and into the bilge area.
8. Screw the oil drain bilge plug (H) into the bilge drain (A) and tighten firmly.

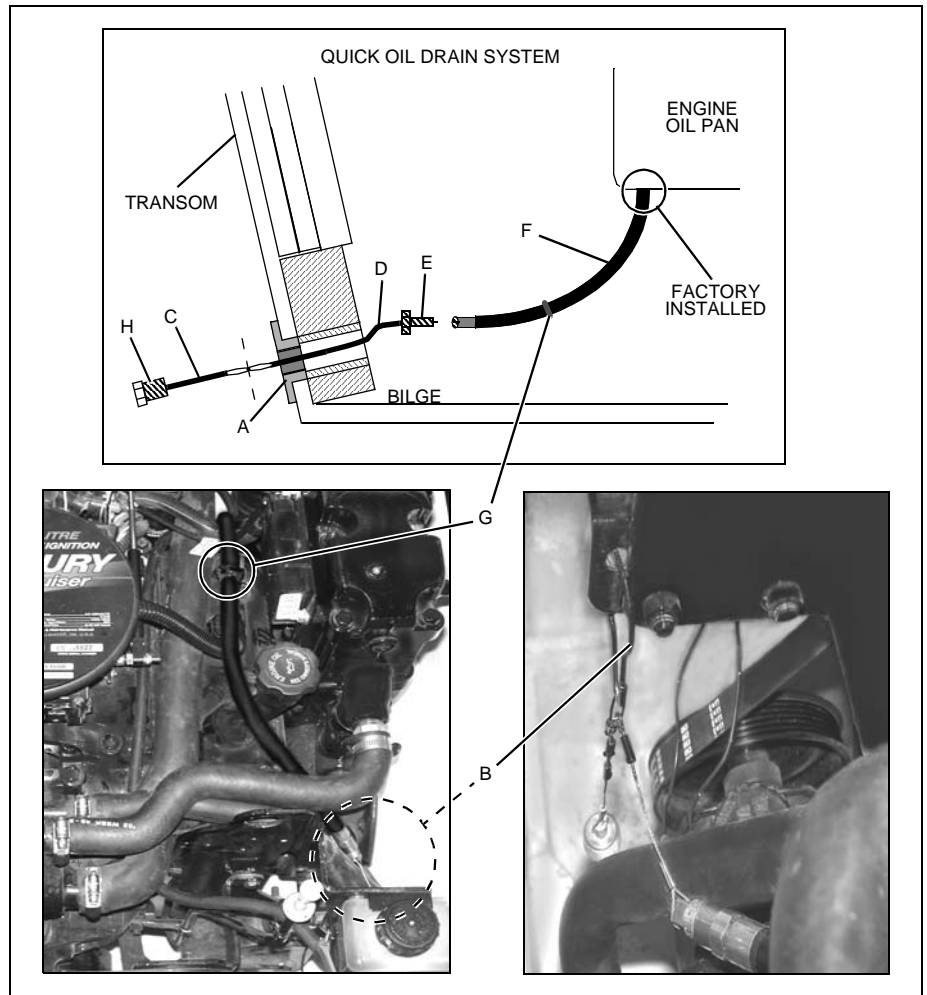

### To drain the engine oil:

1. Remove the boat from the water.
2. Unscrew the bilge plug.
3. Pull the draw cord until the oil drain plug and the oil drain hose slide out of the bilge drain.
4. Place the end of the oil drain hose into a suitable container.
5. Unscrew the oil drain plug and drain the engine oil.
6. Replace the oil drain plug.
7. Push the drain hose back into the bilge.
8. Replace the bilge plug and tighten firmly.

**Always dispose of waste oil in accordance with local regulations.**

## Chapter 4: Controls & Gauges

---

### Steering

#### *Hydraulic Steering System*

- Your boat features a hydraulic steering system.
- Check the fluid level in the hydraulic steering reservoir *every time* you use your boat.
- Boat steering is *not* self-centering.
- Refer to the engine manual for more steering system details.

### Shift/Throttle Controls

 <b>WARNING!</b>
<b><i>LOSS OF CONTROL HAZARD!</i></b>
<b>Improper maintenance of shift/throttle hardware may cause a sudden loss of control!</b>

Read *all* of the information about the shift/throttle controls in the shift/throttle controls' manual, the engine operation manual, and the *Cruiser & Yacht Owner's Manual*.

### Power Trim & Tilt

- The stern drive on your boat is equipped with power trim and tilt.
- Trim and tilt instructions are provided in the engine operation manual and the shift/throttle manual.

## Trim Tabs

- **Before** using the trim tabs, read the trim tabs' owner's manual.
- The trim tabs are controlled by two rocker switches at the helm.
- Check and refill the trim tab hydraulic fluid reservoir as directed in the trim tabs' owner's manual. For the location of the fluid reservoir, see the *Component Locations* section of *Chapter 2* in this supplement.

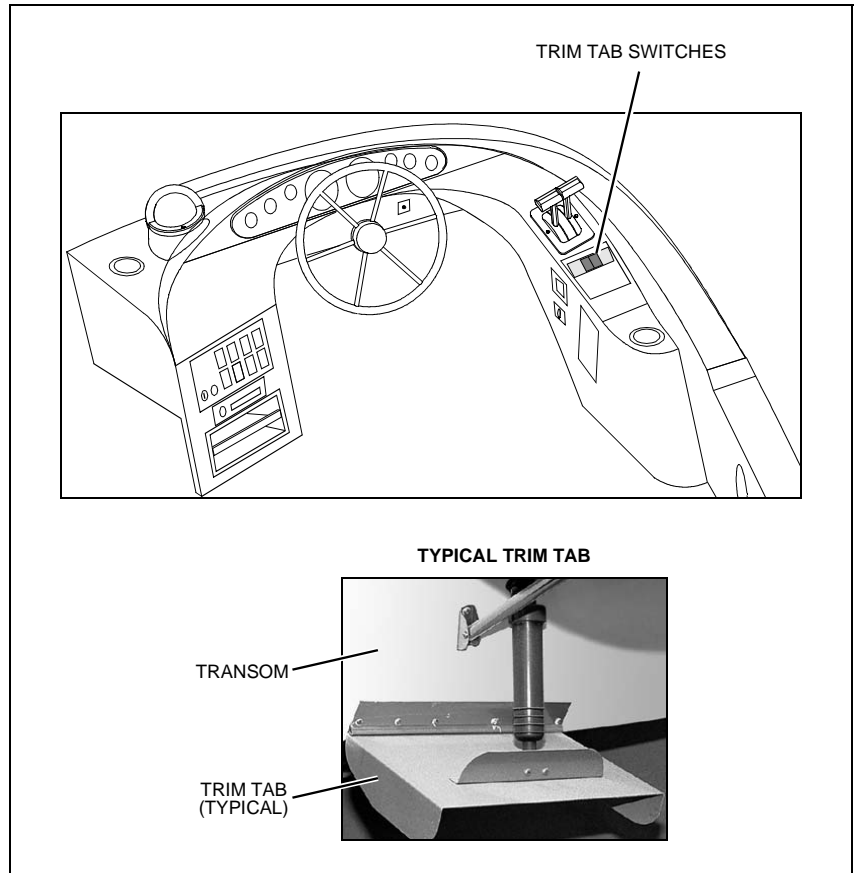

## Gauges

### *Cleaning the Gauges*

 <b>CAUTION</b>
<b><i>PRODUCT or PROPERTY DAMAGE HAZARD!</i></b>
<ul style="list-style-type: none"><li>• Use only mild soap and water to clean the gauge lenses and bezels.</li><li>• Use of other cleaners, including common window cleaning solutions, may cause the lenses to crack.</li><li>• Lenses cracked in this manner will <b>NOT</b> be covered by our warranty.</li></ul>

### ***Gauge Fogging***

- Moisture may occasionally find its way into the gauges causing lens fogging.
- Turning ***On*** the gauge lights will help dry the lenses.
- Fogging will not harm the gauges.

### ***Radio Transmission Interference***

VHF or other radio transmissions may cause brief erratic readings on the tachometer. This will not damage the tachometer gauge or affect its accuracy when not transmitting.

### ***Fuel Gauge***

It is normal for the pointer on your fuel gauge to bounce as fuel sloshes back and forth in the fuel tank.



## Chapter 5: Navigation & Communication Equipment

---

Read the manuals for *all* navigation & communication equipment *before* using these systems.

### Compass

#### NOTICE

- **Compass accuracy can be affected by many factors.**
- **Have a qualified technician calibrate your compass.**
- **Make sure the technician gives you a deviation card which shows the corrections to apply in navigational calculations.**
- **Keep a copy of the deviation card at the helm.**

### Depth Finder



#### WARNING!

- **Do *NOT* use the depth finder as a navigational aid to prevent collision, grounding, boat damage or personal injury.**
- **When the boat is moving, submerged objects will *NOT* be seen until they are already under the boat.**
- **Bottom depths may change too quickly to allow time for the boat to react.**
- **If you suspect shallow water or submerged objects, run the boat at very slow speeds.**

### VHF Radio (If Equipped)

- Your boat may include a VHF (Very High Frequency) radio.
- As permitted by the FCC (Federal Communications Commission), the VHF radio can be used to access weather reports, summon assistance, or contact other vessels.
- Contact the FCC for licensing, rules and regulations concerning VHF radio usage.

## Chapter 6: Plumbing

### Bilge Pumps

#### NOTICE

Discharge of oil, oil waste or fuel into navigable waters is prohibited by law. Violators are subject to legal action by the local authorities.

- Your boat is equipped with two bilge pumps for pumping water out of the bilge.
- The bilge pumps are controlled by automatic float switches (autofloat switches) and/or switches at the helm.
- The bilge pumps are wired directly to the battery.
- Unless the battery is dead, the pumps should work even when the boat is unattended.

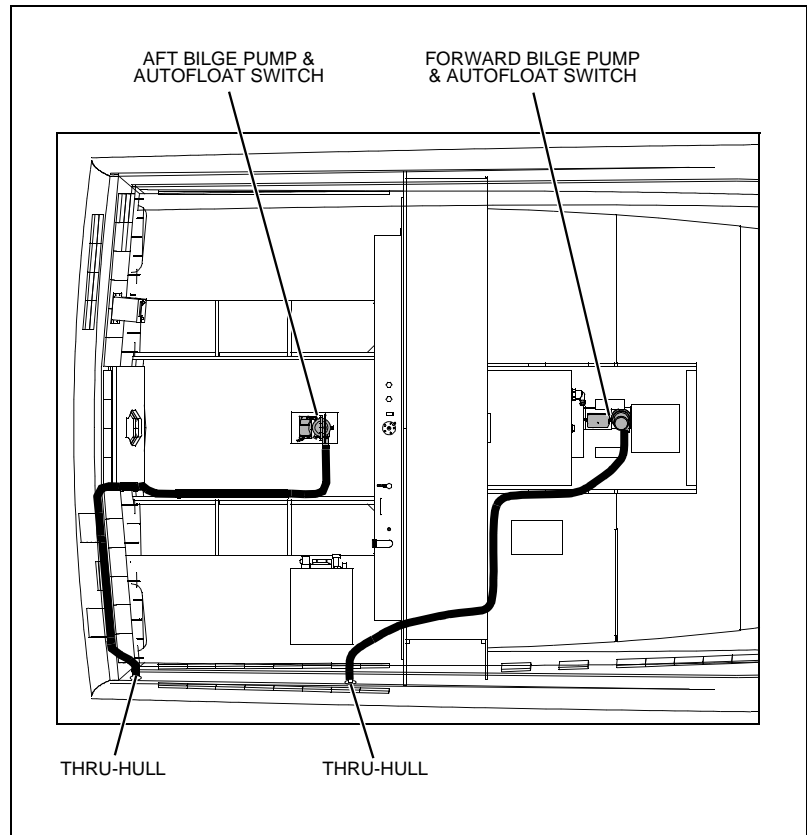

### Bilge Pump Testing

- The bilge pumps are vital to the safety of your boat.
  - Test the bilge pumps often.
1. One at a time, turn **On** each bilge pump switch at the helm.
  2. Make sure that water in the bilge is pumped overboard.
- If there is water in the bilge and the pump motor is running but **not** pumping, inspect the discharge hose for a kink or collapsed area.
  - If the discharge hose looks okay, check the bilge pump housing for clogging debris (see below).

### Checking for clogging debris:

1. Remove the pump motor from the housing:
  - a. Lift the tab while rotating the fins counter-clockwise.
  - b. Lift out the pump motor.
  - c. Clear the housing of debris.
2. Reinstall the pump motor:
  - a. Make sure the "O" ring is properly seated.
  - b. Coat the "O" ring with a light film of vegetable or mineral oil.
  - c. Align the cams on either side of the pump motor with the slots on the housing.

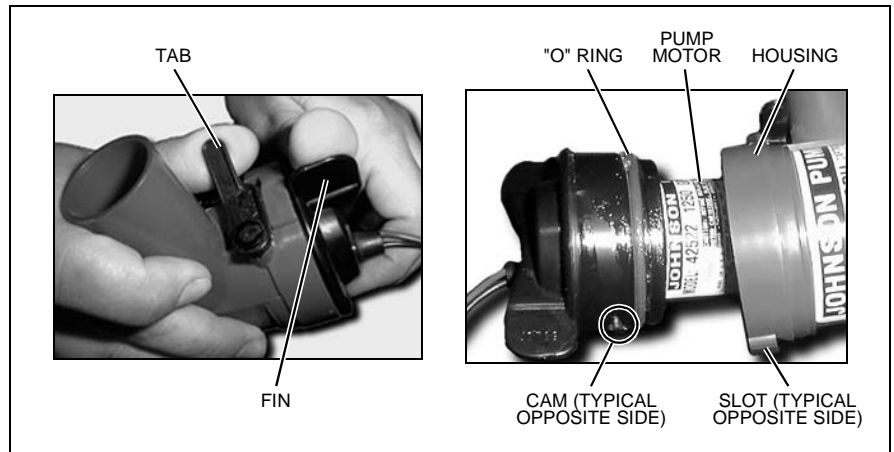

- d. Press the pump motor into the housing while twisting clockwise.
3. Check the reinstallation by trying to twist the fins counter-clockwise **without** lifting the tab; the pump motor should stay in place.

### Autofloat Switches

- The autofloat switches turn the bilge pumps **On** when water rises above a preset level.
- Test each autofloat switch often.

#### Autofloat switch testing:

1. Lift the autofloat switch test button to turn **On** the bilge pump.
  - If the pump does not turn **On**, check the push-to-reset circuit breaker.
  - If the circuit breaker is good, but the switch still does not work, it may mean the switch is bad, or the battery is dead.
2. After testing, push the test button all the way **down** to reset auto mode.

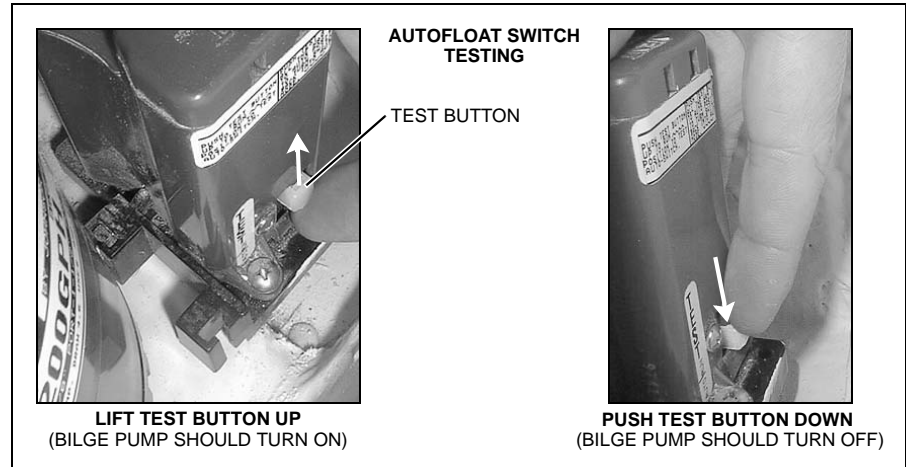

## CAUTION

When the test is completed on each float switch, you **MUST** push the test button **ALL THE WAY DOWN** to reset auto mode!

## Seawater Systems

### Seacocks

 **WARNING!**

**FLOODING and SWAMPING HAZARD!**

- *Close* the seacock(s) when leaving your boat unattended for any length of time.
- If a seacock is left open, a hose failure could flood the bilge, swamp the batteries and the engine, and even sink your boat.

 **CAUTION**

**SYSTEM DAMAGE HAZARD!**

- *BEFORE* using any system that has a seacock, make sure that the system's seacock is *Open*.
- Inspect and lubricate all seacocks annually.

Thru-hull inlet or outlet fittings near or below the waterline feature seacock valves. You can close a seacock to stop water entry:

- If the hose connected to the seacock fails, or;
- To work on equipment served by the seacock.

Seacocks are used on your boat in seawater intake or liquid-discharge systems including, but not limited to:

- Air conditioner (if equipped)
- Marine head (toilet)

*Before* using any system with a seacock, make sure the seacock is *Open* and stays *Open* until the system is shut *Off*.

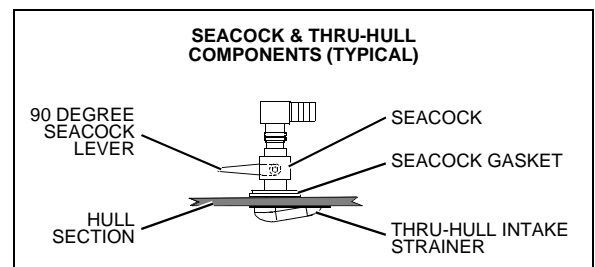

### Seawater Strainers

 **CAUTION**

**FLOODING HAZARD!**

- *BEFORE* taking apart a seawater strainer for cleaning or other maintenance, *Close* the seacock that sends seawater to that strainer.
- Failure to close the seacock before taking apart the seawater strainer may allow large amounts of water to flood the bilge, which could swamp the batteries and the engines, and even sink your boat.
- Keep the seacock *Closed* until the seawater strainer is completely reassembled.

**SYSTEM DAMAGE HAZARD!**

- After putting the seawater strainer back together, make sure that the seacock valve is *Open* *BEFORE* using the component/system.

- Seawater strainers are used to filter incoming seawater in *some* seawater intake systems. NOTE: Not all seawater intake systems have seawater strainers.
- If equipped, the seawater strainer is located near the seawater intake system's seacock.
- Check the strainers for leaks and/or debris *every time* you use your boat.
- Refer to the seawater strainer instruction sheet for cleaning and maintenance information.

## Freshwater System

**⚠ WARNING!**

- **ONLY** use safe drinking (potable) water in your boat's freshwater system.
- **ONLY** use FDA approved "drinking water safe" hoses when filling the freshwater tank.
- **NEVER** use common garden hoses for drinking water.

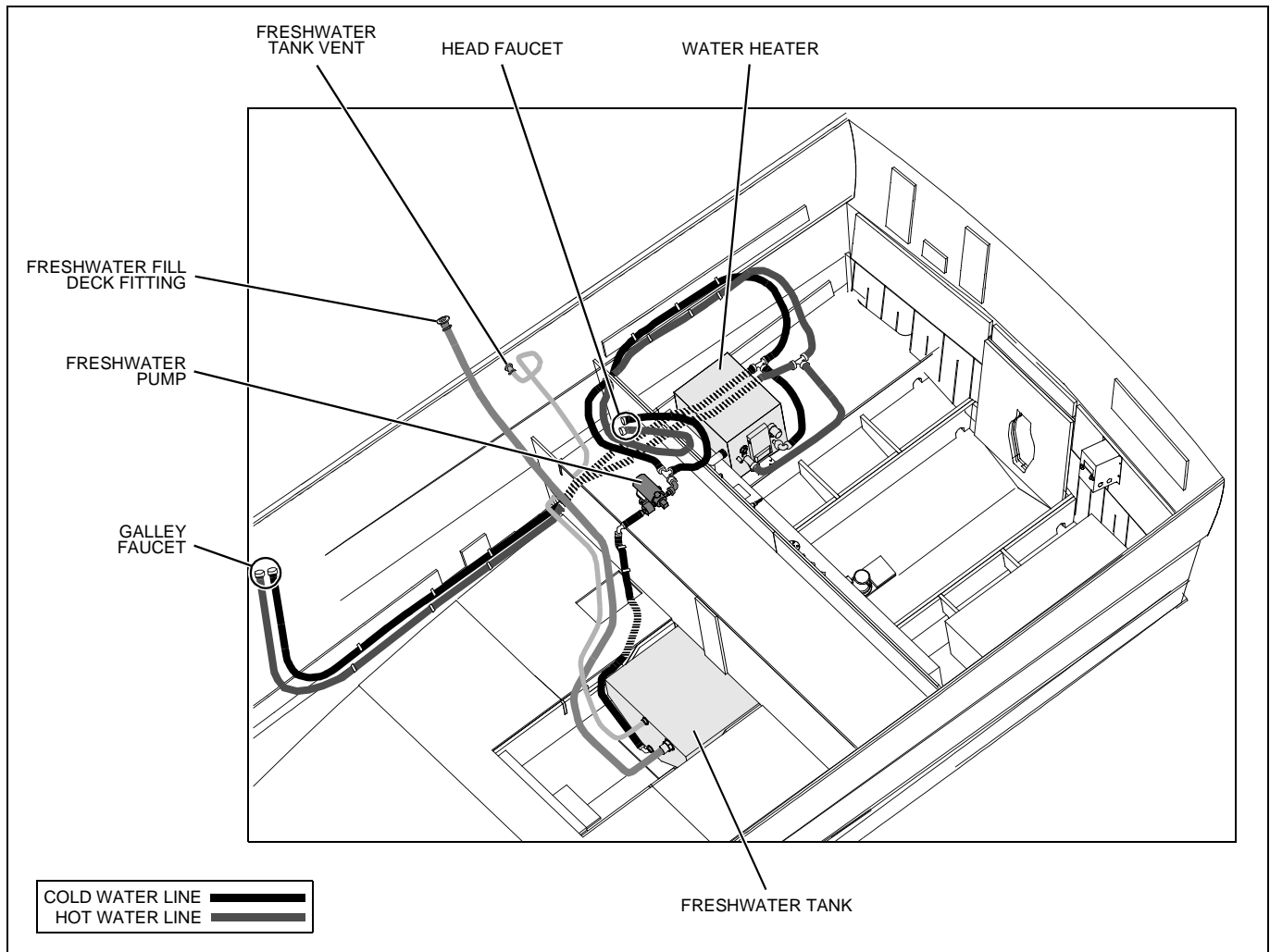

- Read the *Freshwater System* section in the *Cruiser & Yacht Owner's Manual*.
- The freshwater fill deck fitting is marked **WATER**.
- Pressurize the freshwater system by turning **On** the freshwater pump switch (the battery switch must also be **On**).
- For the location of the freshwater pump switch, see the *Component Locations* section of *Chapter 2* in this *supplement*.
- **Always** turn **Off** the city water supply on the dock before leaving your boat unattended.
- Turn **Off** the freshwater pump switch when your boat is **not** in use or when the freshwater tank is empty.
- Inspect and clean the freshwater filter often (the filter is located on the freshwater pump).
- If your boat is to be left unattended for a long period of time, pump the freshwater tank dry to prevent stored water from becoming stagnant and distasteful.
- If the freshwater system needs to be disinfected, ask your dealer about treatments available for your boat's system.

### Freshwater System Winterization

1. Turn **Off** the water heater breaker switch.  
**NOTE:** **Tag** or **Mark** the water heater breaker switch to prevent it from being turned **On** while the water heater tank is empty.
2. Turn **On** the freshwater pump switch.
3. **Open all** of the faucets and showers and let the freshwater system drain completely.
4. Turn **Off** the freshwater pump switch.

**All** of the remaining water **must** be removed from the water lines. There are two ways to remove the remaining water from the lines:

- Compressed Air
- Gravity Draining

### Compressed Air

 **CAUTION**

**FRESHWATER SYSTEM DAMAGE HAZARD!**

- A faucet must be open when compressed air is blown through the freshwater system.
- **NEVER** blow compressed air through the water system when **ALL** of the faucets are **Closed**.

You **must** have an air compressor with an air hose and an air nozzle.

1. Remove the water line from the outlet side of the freshwater pump (opposite side from filter).
2. **Open** the faucet that is furthest away from the freshwater pump.
3. Place the air nozzle against the end of the just removed water line and blow air through the system.
4. When water stops coming out of the faucet, stop the air and **Close** the faucet.
5. One at a time, repeat this process on **all** faucets and showers.

### Gravity Draining

1. **Open all** faucets and showers.
2. Remove the drain plug from the tee fitting on the freshwater tank.
3. When the water has stopped draining from the freshwater tank and the water lines, replace the drain plug.

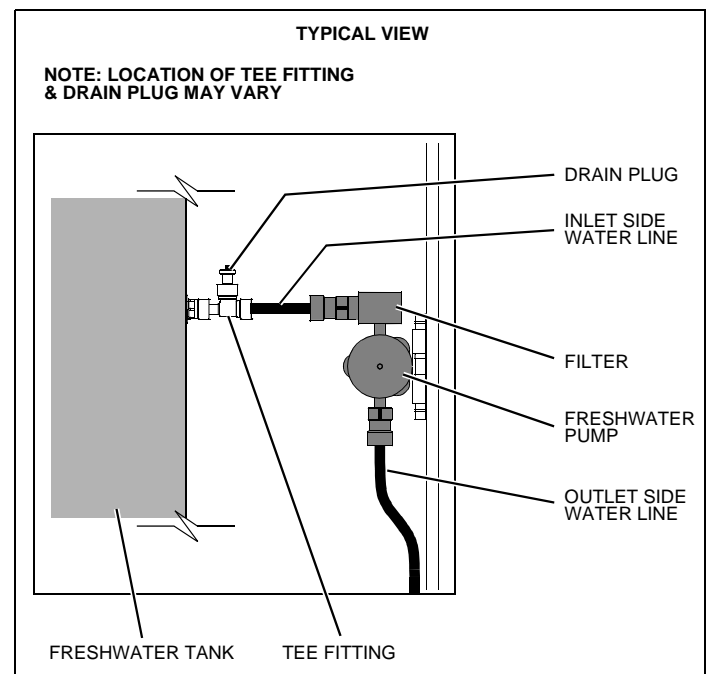

## Water Heater

**⚠ WARNING!**

**⚠ SCALDING HAZARD!**  
Water heated by the water heater can be hot enough to scald the skin.

**⚠ CAUTION**

**WATER HEATER DAMAGE HAZARD!**

- Do **NOT** turn **On** the water heater circuit breaker on the 110-volt AC master panel until the water heater tank is **COMPLETELY** filled with water.
- The tank is full if water flows from the tap when the hot water is turned **On** in the galley.
- Even brief water heater operation with a dry tank **WILL** damage the heating elements.
- Warranty replacements will **NOT** be made on elements damaged in this manner.
- Drain the water heater and turn the power **Off** when the chance of freezing exists (see the winterizing instructions below).

**NOTICE**

**If 110-volt AC power is being provided by shore power, but the water heater is not working:**

- Make sure the water heater circuit breaker on the 110-volt AC master panel is switched **On**.
- If the circuit breaker is **On**, but the water heater is still not working, ask your dealer how to check the push-to-reset circuit breaker located on the water heater.

- Read the water heater instruction manual and heed the warnings above.
- The water heater is connected to the 110-volt AC power system.
- To heat the water, turn **On** the water heater circuit breaker on the 110-volt AC master panel.

## Winterizing the Water Heater

**NOTICE**

**The freshwater system *MUST* be drained *BEFORE* winterizing the water heater (see the *Freshwater System Winterization Instructions* on the previous page).**

1. Turn **Off** the water heater breaker.
  2. Disconnect the hose (A) attached to the pressure relief valve (B).
  3. If there is any water in this hose, drain it into the bilge or into a bucket.
  4. **Open** the pressure relief valve (B).
  5. **Open** the drain valve (C).
- Leave the pressure relief and drain valves **Open** until you fit out your boat after storage.

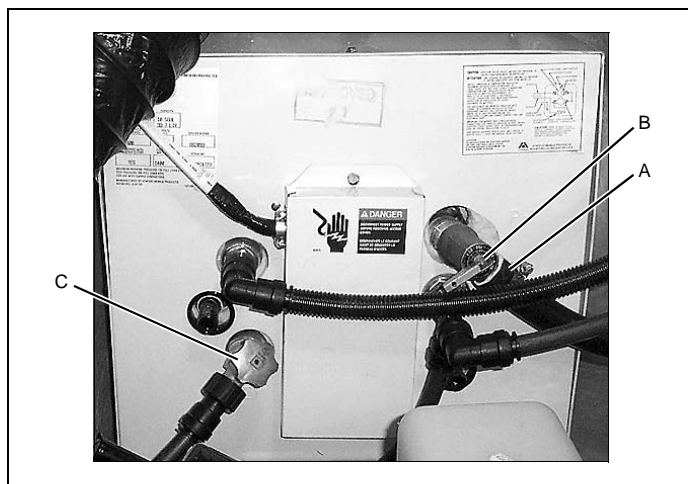



## Drain Systems

### Deck Drains

- Water on the deck is drained overboard through the deck drains.
- Keep the deck drains free of debris.

### Gray Water Gravity Drains

The head sink and galley sink are above the waterline and are gravity drained overboard.

### Shower Drain System

- The shower drains into the sump pump box.
- The sump pump box has an auto-float switch.
- When the drain water rises to a preset level, the autofloat switch turns **On** the sump pump, and the drain water is pumped overboard.

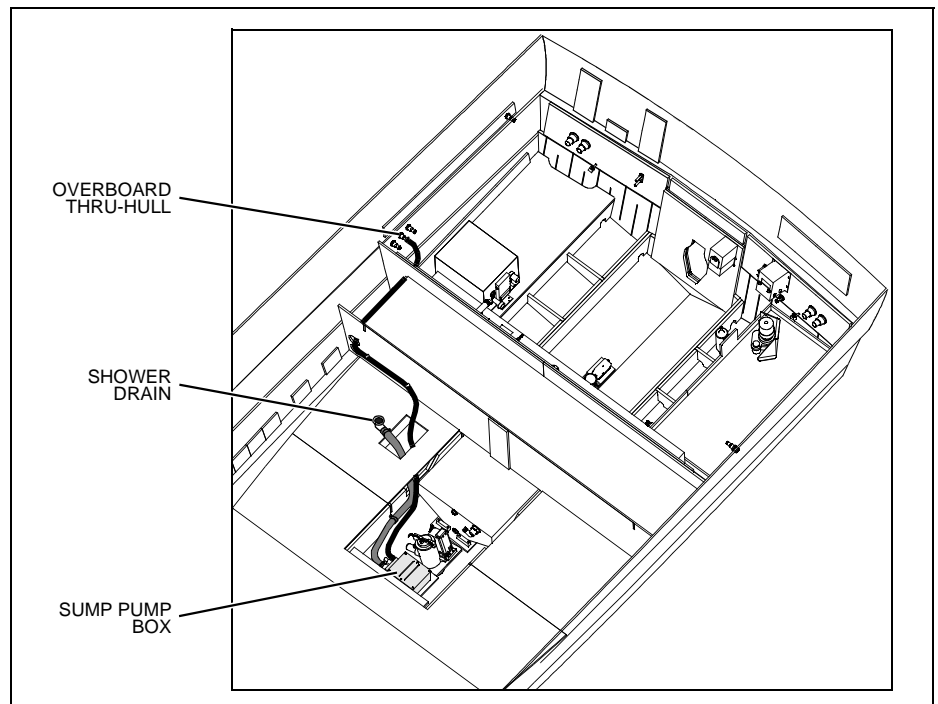

### Sump Box Cleaning

Periodically clean the sump box (A), filter, and pump as follows:

1. Remove the cover screws (B) and the cover (C).
2. Remove any debris from the box and the filter.
3. Clean the sump pump as outlined in the *Bilge Pump* section of this chapter.

### Sump System Winterization

Drain the sump pump system in the months when **not** in use.

1. Disconnect and drain **all** lines to the unit.
2. Remove the screws from the mounting feet (D) and drain the system.
3. Reinstall the screws in the mounting feet and reconnect the system.

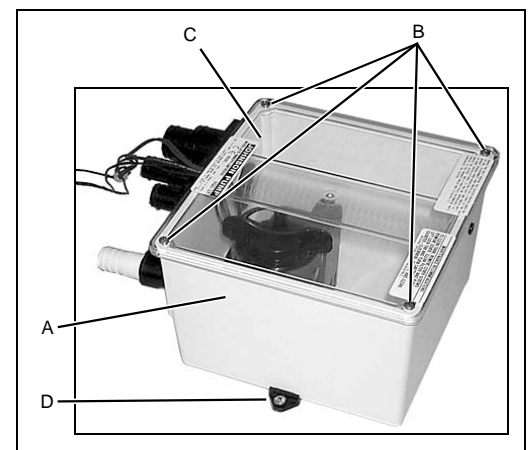

## Marine Head & Holding Tank

**NOTICE**

Check with local authorities for regulations regarding the legal use of marine head systems.

**WARNING!**

**FLOODING and SWAMPING HAZARD!**

- **Close** the seawater intake seacock when leaving your boat unattended for any length of time.
- **If the seacock is left open, a hose failure could flood the bilge, swamp the batteries and the engine, and even sink your boat.**

- **Before** using this system, read the marine head's operation and maintenance manual.
- Look at the side of the holding tank to check the content level.
- The dockside pump-out deck fitting is marked WASTE.
- Empty the holding tank at every opportunity.

### Using the Marine Head

1. **Open** the head's seawater intake seacock.
  2. **Before** using the head, pump water into the bowl to wet the sides.
  3. After use, pump until the bowl is clean.
  4. Pump a few more times to clean the lines.
  5. If excess waste causes the water to rise in the bowl, stop pumping until the water recedes.
- **Close** the intake seacock when the system will not be used for long periods of time.

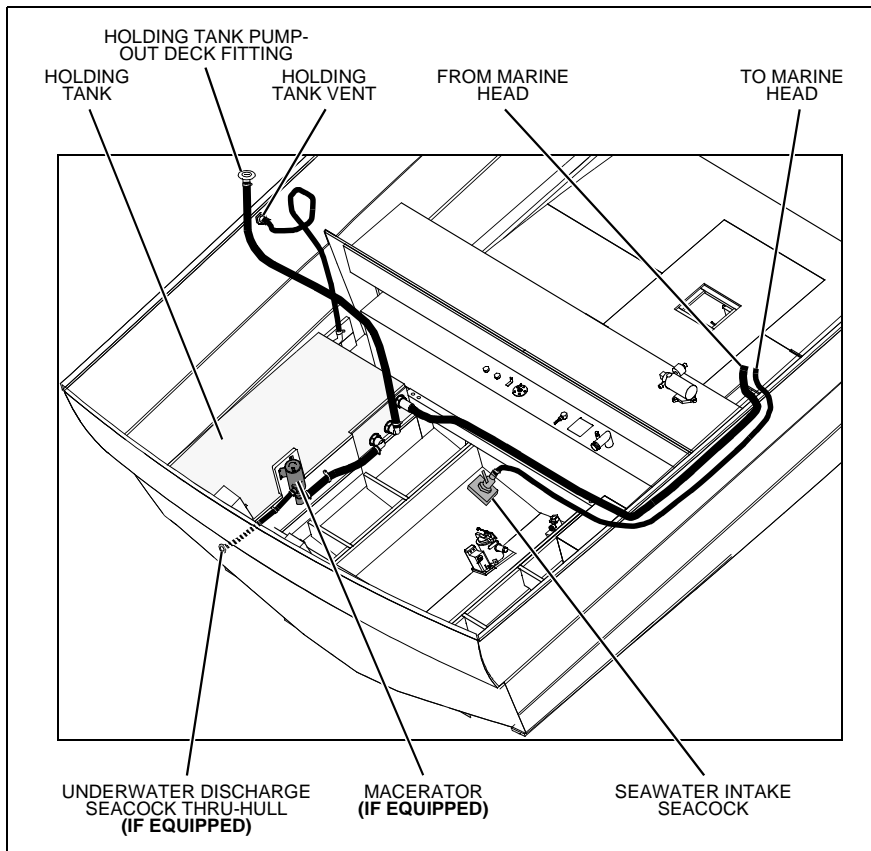

### Winterizing the System

Read the marine head's operation and maintenance manual for winterizing instructions.

### Macerator (If Equipped)

To use the macerator to pump waste directly overboard (where regulations permit):

1. **Open** the overboard discharge seacock.
2. Press both macerator switches at the same time to run the pump.
3. Stop running the macerator as soon as the holding tank is empty.
4. **Close** the overboard discharge seacock when you are done pumping.

## Chapter 7: Deck Equipment

---

### Cleats & Tow Eyes

 <b>WARNING!</b>
<b><i>PERSONAL INJURY and/or PRODUCT or PROPERTY DAMAGE HAZARD!</i></b>
<b><i>NEVER</i></b> lift your boat using the bow and stern eyes or the cleats.

Read the section on towing in the *Cruiser & Yacht Owner's Manual* **before**:

- Towing anything behind your boat.
- Being towed by another vessel.

### Canvas & Vinyl Tops & Enclosures

 <b>CAUTION</b>
<b><i>PRODUCT or PROPERTY DAMAGE HAZARD!</i></b>
Take down and securely stow <b><i>ALL</i></b> canvas <b><i>BEFORE</i></b> transporting your boat by road.

<b>NOTICE</b>
Two people are needed for most of the tasks listed in this section.

<b>NOTICE</b>
<b><i>BEFORE</i></b> cleaning and/or stowing your canvas or vinyl, read the sections later in this chapter, <i>Canvas Care</i> and <i>Vinyl Care</i> .

Make sure your dealer explains how to install the canvas and vinyl (if equipped).

### **Canvas Care (see also 'Clear Vinyl Care' on next page)**

- After each use, especially in saltwater, rinse the canvas with cold freshwater.
- **Before** stowing, let the canvas air-dry completely.
- The canvas can be rolled or folded for stowage.

### **Cleaning the Canvas**

 <b>CAUTION</b>
<p><b>NEVER use detergents when washing the canvas. Detergents can destroy the water repellency, and mildew/UV resistant finish of your canvas.</b></p>

Regularly clean the canvas to prevent dirt, pollen, and etc. from embedding in the fabric. Generally, it is easiest to wash the canvas while it is installed on your boat.

- Use a soft-bristled brush to remove all dust and loose dirt.
1. Hose down the canvas with freshwater.
  2. Gently wash the canvas with a solution of lukewarm water (no more than 100° F) and non-detergent soap, such as Lux or Ivory Flakes.
  3. Rinse thoroughly to remove the soap.
  4. **Before** stowing, let the canvas dry completely.

### **Stubborn Stains**

 <b>CAUTION</b>
<ul style="list-style-type: none"> <li>• <b>Soaking in bleach solutions may remove the waterproof finish of the fabric and may also decrease the life of the polyester thread used in the canvas.</b></li> <li>• <b>If needed, a water repellent treatment should be reapplied to your canvas. Ask your dealer about the treatments available for your boat's canvas.</b></li> </ul>

Some stubborn stains may resist normal washing and you can try the methods below. However, these methods may remove the waterproof finish of the fabric and may also decrease the life of the polyester thread used in the canvas. Reapply a water repellent treatment as needed.

#### **Method 1**

1. Add 1/8 cup (2 oz.) of **non-chlorine** bleach to one gallon of water and mix thoroughly.
2. Thoroughly wet the canvas and then gently scrub the stained area with the weak bleach solution.
3. Rinse with cold water to remove all of the solution.

#### **Method 2**

1. Add 1/2 cup (4 oz.) of **non-chlorine** bleach and 1/2 cup (4 oz.) Ivory Flakes to one gallon of water and mix thoroughly.
2. Soak the canvas in this solution for about 20 minutes.
3. Rinse with cold water to remove all of the solution.

### Clear Vinyl Care

CAUTION

- **NEVER** store the clear vinyl pieces wet, as this will cause a milky film to develop.
- **NEVER** fold or crease the clear vinyl pieces as cracking will occur.
- Clear vinyl is **NOT** intended for use when your boat is in storage or being moored.
- Clear vinyl does **NOT** hold up well against ultraviolet rays.
- Under direct sunlight conditions, do **NOT** let the clear vinyl touch the framework. The framework radiates heat and can burn the clear vinyl.

- After each use, especially in saltwater, rinse the clear vinyl with cold freshwater.
- **Before** stowing, the clear vinyl must be completely dry. Air-drying is best, but you can also carefully dry the vinyl with a chamois or soft cotton cloth.
- The clear vinyl can be rolled or laid out flat for stowage.
- **Never** fold or crease the clear vinyl parts as cracking will occur.



#### Cleaning Clear Vinyl

Regularly clean the clear vinyl to prevent dirt, pollen, and etc. from marring the surface. Generally, it is easiest to clean the clear vinyl while it is installed on your boat.

1. Hose down the clear vinyl with freshwater.
  2. Using a soft cotton cloth (**paper towels are abrasive and should never be used on clear vinyl**), gently wash the clear vinyl with soap and water.
  3. Rinse thoroughly to remove the soap.
  4. **Before** stowing, the clear vinyl must be completely dry. Air-drying is best, but you can also carefully dry the vinyl with a chamois or soft cotton cloth.
- Ask your dealer about products available to keep the clear vinyl polished and looking new.

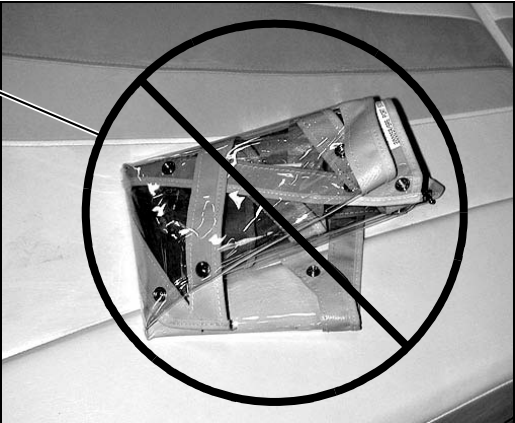
**NEVER FOLD OR CREASE CLEAR VINYL!**  
 FOLDING OR OTHERWISE CREASING CLEAR VINYL WILL CAUSE DAMAGE SUCH AS CRACKING TO OCCUR

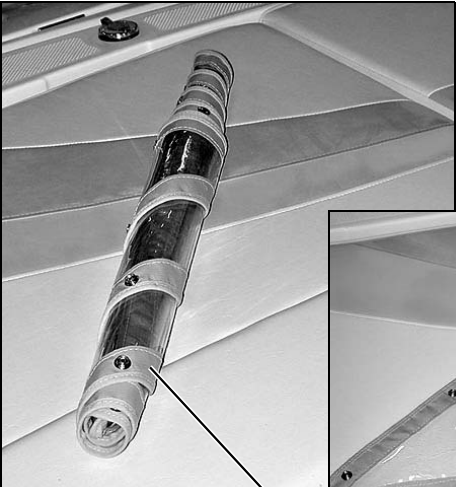

AFTER CLEAR VINYL PARTS HAVE COMPLETELY AIR DRIED THEY CAN BE ROLLED OR SIMPLY LAID FLAT FOR STOWAGE

## Pre-wiring For Windlass

- The deck is pre-wired to support the installation of a windlass.
- Contact your selling dealer for help with choosing and installing a windlass.

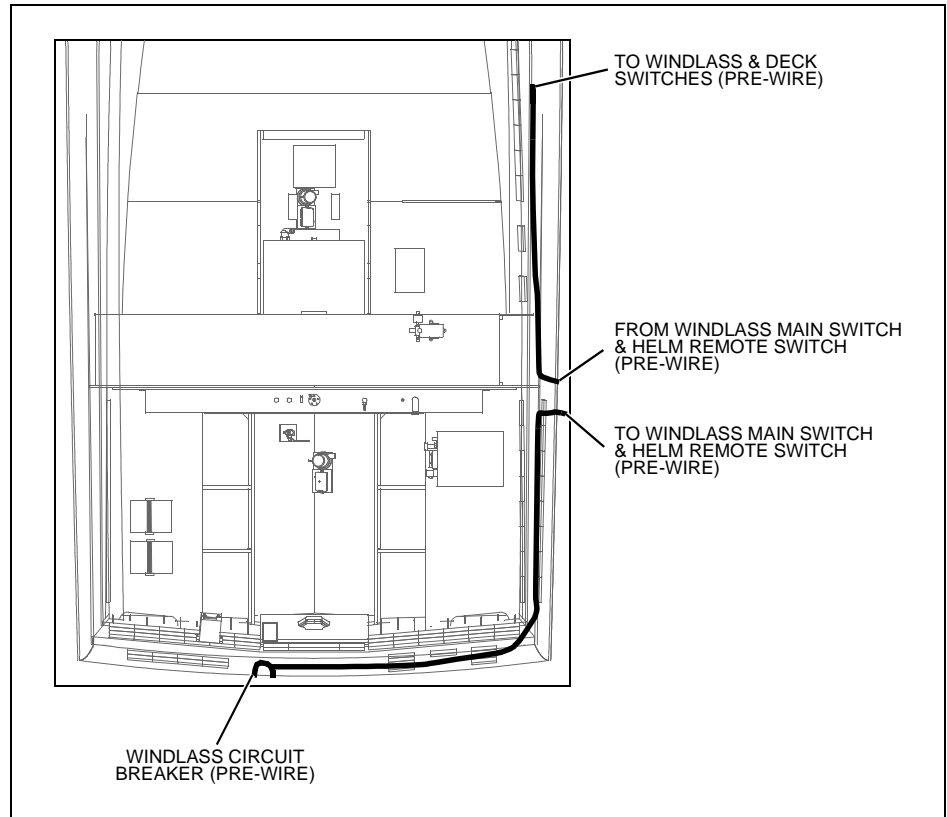

## Chapter 8: Appliances & Entertainment Systems

---

### NOTICE

**ALWAYS** keep an approved ABC-type fire extinguisher in galley area.

- The separate instruction sheets or manuals for *all* appliances and entertainment systems contain detailed instructions and important safeguards.
- Read these instruction sheets and manuals *before* using your boat's appliances and entertainment systems.
- If applicable, make sure the 110-volt AC breaker is turned *On* for the appliance or entertainment system you wish to use.

### Refrigerator

The refrigerator runs on 12-volt DC power *unless* 110-volt AC power is being supplied by shore power *and* the refrigerator's circuit breaker on the 110-volt AC master panel is *On*.

### Audio Equipment

### NOTICE

AM radio reception may be impaired anytime the engine is running.

## Alcohol/Electric Stove

 **DANGER!**





***CARBON MONOXIDE POISONING HAZARD!***

- The alcohol stove is a source of dangerous carbon monoxide gas (CO).
- *BEFORE* using the alcohol stove, *Open* doors and windows to make sure there is enough fresh air for ventilation.
- Read the *Carbon Monoxide (CO)* section of *Chapter 1* in this supplement.

 **WARNING!**

- Open flame cooking appliances consume oxygen. This can cause asphyxiation or death.
- Maintain open ventilation.

 **WARNING!**



***BURN/SCALDING and/or FIRE HAZARD!***

- Read the stove's instruction manual *BEFORE* using.
- *ALWAYS* keep an approved ABC-type fire extinguisher in the galley area.
- Do *NOT* use the stove while underway.
- Any non-cooking devices on or near your stove during use are potential fire hazards!
- Do *NOT* touch the burners, grates or nearby surfaces as they may be hot even when they are dark in color.
- Areas near the burners and grates may become hot enough to cause burns.
- During and after use, do *NOT* touch or let clothing or other flammable material come in contact with the heated units or the areas near the units (burner tops, main frame sides and back, sea rails and pot holders) until they have had sufficient time to cool.

 **CAUTION**

***PRODUCT DAMAGE HAZARD!***

To prevent overheating which can destroy the electric burner elements, *NEVER* try to use both alcohol and electric burners at the same time.



## Chapter 9: Convertible Seats, Beds, & Tables

### Dinette to Berth Conversion

The dinette table can be removed and the dinette area can be converted into a berth.

1. Lift the table (A) and remove the table legs (B).

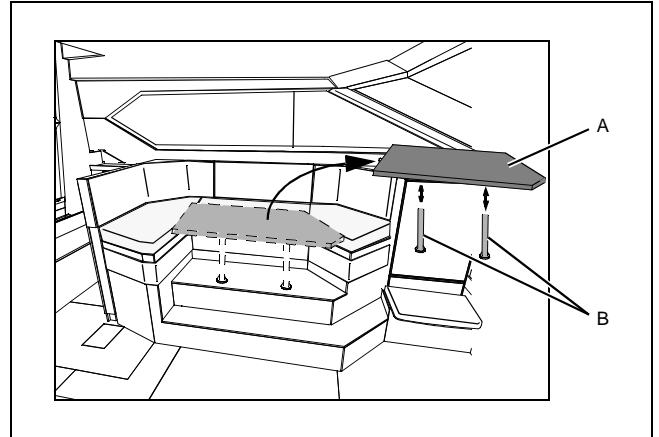

2. Place the table (A) so that it fits securely on the edge lips at the front of the dinette seats.

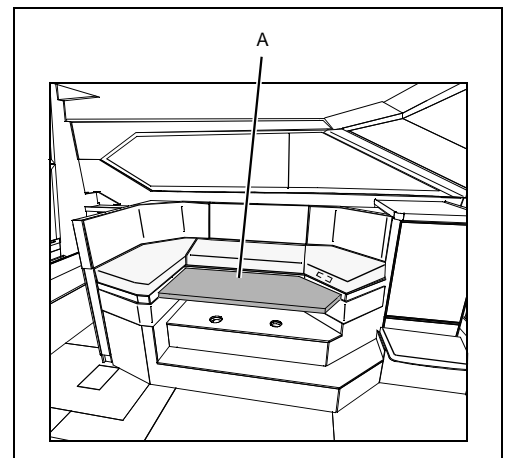

3. Place the filler cushion (C) on top of the table.

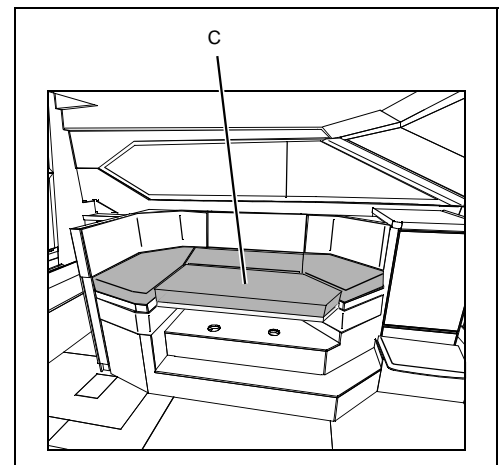

## Chapter 10: Lights

---

### Care and Maintenance

All of the lights installed on your boat are of top quality, but you should be aware that failure may periodically occur for a variety of reasons:

1. There may be a blown fuse - *replace the fuse.*
2. The bulb may be burned out - *carry spare bulbs for replacement.*
3. A wire may be damaged or may have come loose - *repair as required.*
4. The bulb base may be corroded - *clean the base and coat it with non-conductive electrical lubricant.*

### Interior & Exterior Lights



#### CAUTION

- Be conservative in the use of battery power.
- Prolonged use of cabin interior lights (overnight) *WILL* result in a drained battery.

- The lights are powered by your boat's 12-volt DC system.
- The battery switch *must* be turned *On* for the lights to work.

### Navigation Lights



#### CAUTION

Avoid the storage of gear where it would block navigation lights from view.

#### NOTICE

Running lights are legally required to show boat direction and right-of-way at night.

## Chapter 11: Air Conditioning System (If Equipped)

! **DANGER!**



**CARBON MONOXIDE POISONING HAZARD!**

- Dangerous carbon monoxide gas (CO) can be brought into your boat through the air conditioning system.
- Read the *Carbon Monoxide (CO)* section of *Chapter 1* in this supplement.

! **CAUTION**

**SYSTEM DAMAGE HAZARD!**

The air conditioning system's seawater intake seacock **MUST** be *Opened BEFORE* turning *On* the air conditioner and **MUST** stay *Open* during use.

- Read the air conditioner manual *before* using the air conditioning system.
- *Before* using the air conditioning system, make sure the breakers on the 110-volt AC master panel are turned *On* and that the system's seawater intake seacock is *Open*.
- The seacock **must** remain *Open* while the air conditioner is in use.
- Check the seawater strainer for debris *before* each use of the air conditioning system.
- If the strainer needs to be cleaned out, follow the directions in the *Seawater Systems* section of *Chapter 6* in this Supplement.

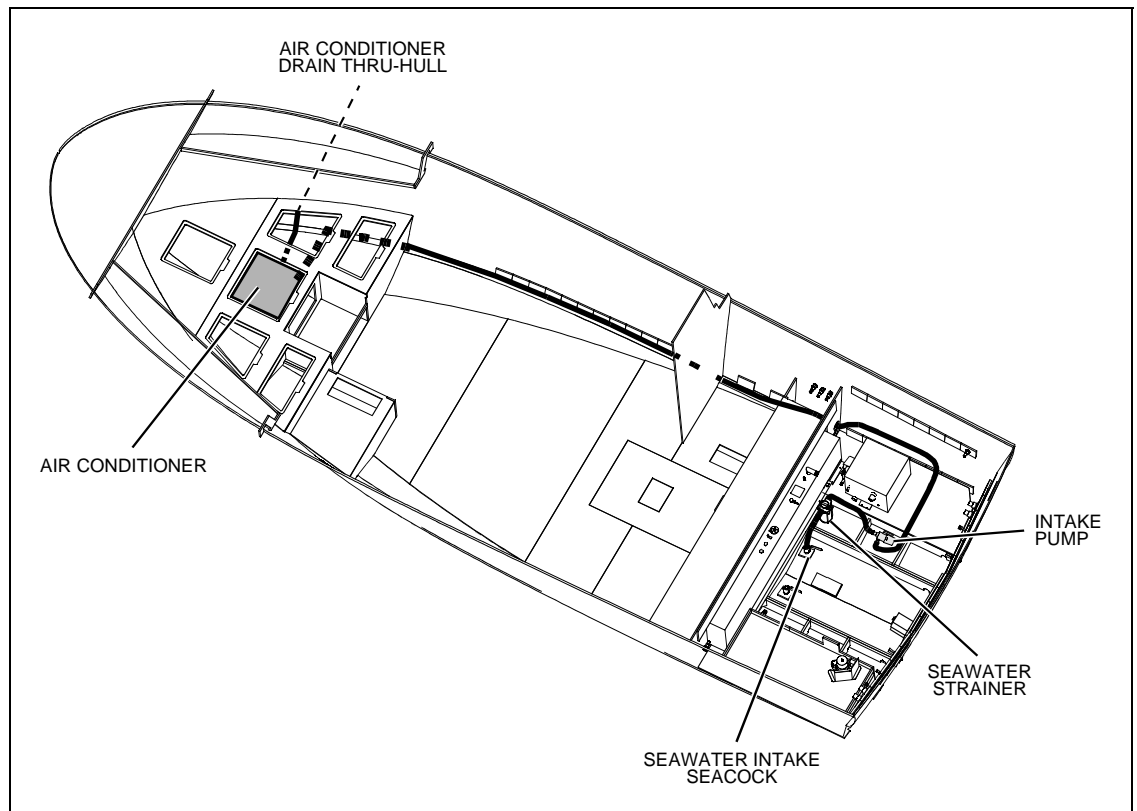

## Chapter 12: Electrical System



**DANGER!**







**EXTREME FIRE, SHOCK and EXPLOSION HAZARD!**

- To minimize the risks of fire and explosion, *NEVER* install knife switches or other arcing devices in the fuel compartment.
- *NEVER* substitute automotive parts for marine parts. Marine electrical, ignition, and fuel system parts were designed and manufactured to comply with rules and regulations that minimize risks of fire and explosion.
- Do *NOT* modify the electrical systems or relevant drawings.
- Have qualified personnel install batteries and/or perform electrical system maintenance.
- Make sure that *ALL* battery switches are turned *Off BEFORE* performing any work in the engine spaces.

**WARNING!**

1  
  
4 min

2  



3  

**FIRE and EXPLOSION HAZARD!**

Fuel vapors can explode! *BEFORE* electrical system maintenance or activation of electrical devices:

1. Check the bilge areas for fuel vapors or leaking fuel. If you see leaking fuel or smell fuel vapors:
  - a. Do *NOT* start the engine, do *NOT* turn *On* any electrical devices, extinguish *ALL* cigarettes, cigars, and other sources of flame or ignition.
  - b. Get everyone off your boat.
  - c. Get trained help to find and fix the problem.
2. Run the bilge blower(s) for at least four minutes prior to engine starting, electrical system maintenance, or activation of electrical devices.

**CAUTION**



**SHOCK and ELECTRICAL SYSTEM DAMAGE HAZARD!**

When the engine is running, *NEVER* turn *Off* the battery switch or disconnect the battery cables. Doing either could cause damage to your boat's engine and/or electrical system.

### NOTICE

Electrical connections are prone to corrosion. To reduce corrosion-caused electrical problems:

- Keep *ALL* electrical connections clean.
- Apply a spray-on protectant that is designed to protect connections from corrosion.

## 12-Volt DC System

### Batteries

- The batteries supply electricity for lights, 12-volt accessories, and engine starting.
- The *Electrical* section of *Chapter 8* in the *Cruiser & Yacht Owner's Manual* provides battery care and maintenance instructions.

### Battery Switch

**⚠ CAUTION**

**⚡ SHOCK and ELECTRICAL SYSTEM DAMAGE HAZARD!**

When the engine is running, *NEVER* turn *Off* the battery switch or disconnect the battery cables. Doing either could cause damage to your boat's engine and/or electrical system.

**NOTICE**

Make sure your selling dealer fully explains how to use the battery switch.

- Standby-loads, such as the automatic bilge pumps and the stereo memory, are not affected by the battery switch since they are wired directly to the battery (see the *Wiring Diagrams* section of this chapter for more details).
- Turn the battery switch to the *Off* position whenever your boat will be unoccupied for long periods of time.

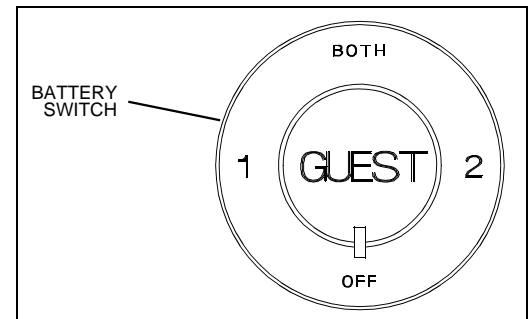

### Battery Switch Positions

**NOTICE**

Since your boat's batteries were installed by your dealer, the battery switch positions listed below may vary. Make sure your selling dealer fully explains how to use the battery switches.

BATTERY SWITCH POSITIONS	ENGINE STARTING	ACCESSORIES & LIGHTS	ENGINE ALTERNATOR	BATTERY CHARGER
POSITION "1"	Battery <u>1</u> Provides Start- ing Power	Battery <u>1</u> Provides Power for Accessories and Lights	Charges Battery <u>1</u>	Charges BOTH Batteries
POSITION "2"	Battery <u>2</u> Provides Start- ing Power	Battery <u>2</u> Provides Power for Accessories and Lights	Charges Battery <u>2</u>	Charges BOTH Batteries
"BOTH" or "1 & 2" POSITION	<u>BOTH</u> Batteries Provide Start- ing Power	<u>BOTH</u> Batteries Provide Power for Accessories and Lights (not advised unless engine is running)	Charges <u>BOTH</u> Batteries	Charges BOTH Batteries

### **Fuses & Circuit Breakers**

- Circuit breakers for engines and main accessory power are on the 12-volt DC push-to-reset circuit breaker panel and on the battery switch panel.
- For the locations of the battery switch panel and the 12-volt DC push-to-reset circuit breakers, see the *Component Locations* section of *Chapter 2* in this *supplement*.

NOTE: Some equipment may have secondary fuse protection at the unit, behind the battery switch panel, or at the batteries.

### **12-Volt DC Accessory Outlets**

 <b>CAUTION</b>
<p><b>Do NOT use the 12-volt DC accessory outlet with a cigarette or cigar lighter. High temperatures may melt the outlet.</b></p>

- The outlets can be used with any 12-volt device which draws 10-amps or less.
- Each 12-volt DC accessory outlet is protected by a 10-amp breaker on the 12-volt DC push-to-reset circuit breaker panel.

### **Alternator**

The alternator will keep the battery properly charged when the engine is running at, or above, cruising speeds.

### **Battery Charger (If Equipped)**

 <b>CAUTION</b>
<p><b>ENGINE and ELECTRICAL SYSTEM DAMAGE HAZARD!</b></p> <p><b>NEVER run your boat's engines and the battery charger at the same time.</b></p>

 <b>CAUTION</b>
<ul style="list-style-type: none"> <li>• <b>The battery charging systems (alternator and battery charger) installed on your boat are designed to charge conventional lead-acid batteries.</b></li> <li>• <b>BEFORE installing gel-cell or other new technology batteries, consult with the battery manufacturer about charging system requirements.</b></li> </ul>

- **Before** using the battery charger, read *all* instructions and warnings: (1) on the battery charger, (2) on the batteries, and (3) in the battery charger manual.
- The battery charger will automatically charge your boat's batteries when 110-volt AC power is being provided by shore power, *and* the battery charger circuit breaker on the 110-volt AC master panel is **On**.
- The battery switch can be in any position during charging.
- During battery charging you may use 12-volt accessories, such as the lights and stereo, but battery charging will take longer.

## 110-Volt AC System

**CAUTION**

**WATER HEATER DAMAGE HAZARD!**

- Do **NOT** turn *On* the water heater circuit breaker on the 110-volt AC master panel until the water heater tank is **COMPLETELY** filled with water.
- The tank is full if water flows from the tap when the hot water is turned *On* in the galley.
- Even brief water heater operation with a dry tank **WILL** damage the heating elements.
- Warranty replacements will **NOT** be made on elements damaged in this manner.

**NOTICE**

- When using shore power, the use of several 110-volt AC accessories at the same time can result in an overloaded circuit.
- You may have to turn *Off* one or more accessories to use another accessory.

- To gain a basic understanding of your boat's 110-volt AC system, read the handbook, *A Boater's Guide To AC Electrical Systems*. If this handbook is not in your owner's packet, call 360-435-8957 and the handbook will be mailed to you.
- The 110-volt AC system is energized by shore power.
- Individual breakers on the 110-volt AC master panel **must** be turned *On* to supply power to the accessories you wish to use.
- The 110-volt AC master panel may contain circuit breakers for accessories that are **not** available for your boat.

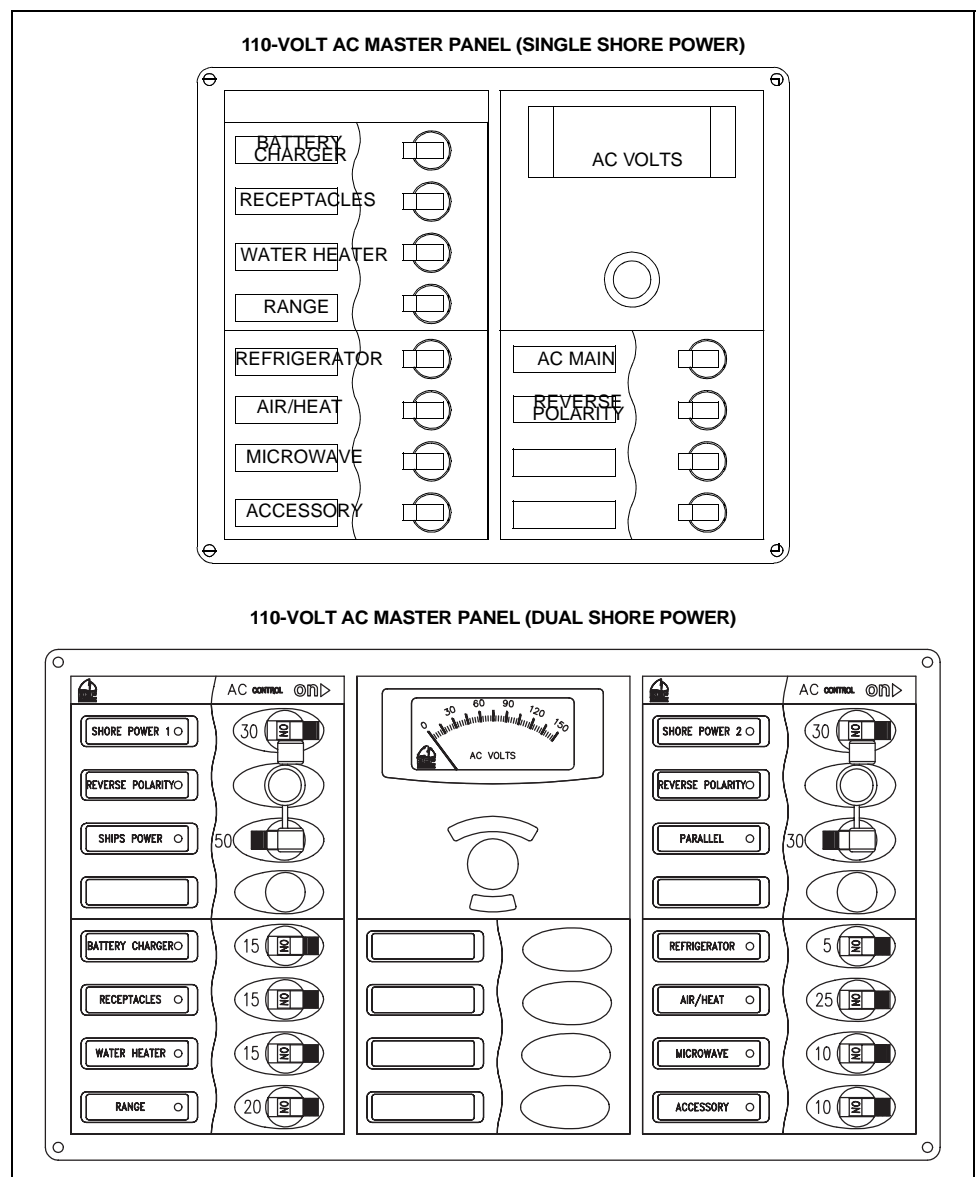



## Shore Power

**DANGER!**



**FIRE, EXPLOSION and SHOCK HAZARD!**

- Use **ONLY** compatible shore power connectors and **NEVER** alter the connectors.
- Turn **Off ALL** breakers and switches on the 110-volt AC master panel **BEFORE** plugging in or unplugging the shore power cord.
- To prevent shock or injury from dropping a "hot" cord into the water:
  - a. **ALWAYS** plug the shore power cord into the boat inlet first, and then into the dockside outlet.
  - b. When unplugging from shore power, **ALWAYS** unplug the shore power cord from the dockside outlet first.
- **NEVER** leave the shore power cord plugged into the dockside outlet **ONLY**.
- **ONLY** use shore power cords approved for marine use. **NEVER** use ordinary indoor or outdoor extension cords.

**WARNING!**



**SHOCK and ELECTRICAL SYSTEM DAMAGE HAZARD!**

- Monitor the polarity indicator lights **EVERY TIME** you connect to shore power.
- If a reversed polarity light turns **On** when you are connecting to shore power, do **NOT** turn **On** the main breaker switches.
- Instead, **IMMEDIATELY** unplug the shore power cord (**ALWAYS** from the dockside outlet first) and alert marina management.

**WARNING!**

**SHOCK and ELECTRICAL SYSTEM DAMAGE HAZARD!**

- **BEFORE** each use, check the shore power cord for defects or damage.
- **NEVER** use a damaged or faulty cord since the danger of fire and electrical shock exists.
- Do **NOT** pinch the shore power cord in doors or hatches, or coil the shore power cord too tightly, since these situations can generate enough heat to result in a fire.
- If a shore power cord is dropped into the water, **COMPLETELY** dry the blades and contact slots **BEFORE** using.

**CAUTION**

**ELECTRICAL SYSTEM DAMAGE HAZARD!**

- **NEVER** connect to dockside power outside of North America unless you have the international electrical conversion option.
- Using several 110-volt AC accessories at the same time can result in an overloaded circuit. You may have to turn **Off** one or more accessories to use another accessory.
- Use double insulated or three-wire protected electrical appliances whenever possible.



- Single shore power 110-volt/60-hertz AC systems features one 110-volt/30-amp shore power receptacle.
- If your boat has an air conditioning system, a second (dual) 110-volt/30-amp inlet has been installed.
- Dual shore power inlets are labeled LINE 1 and LINE 2, which corresponds to the SHORE POWER 1 and SHORE POWER 2 master breakers on the 110-volt AC master panel.
- LINE 1 and LINE 2 are independent of each other except when the parallel switch is used.

### Connecting to Shore Power

**! WARNING!**

**SHOCK and ELECTRICAL SYSTEM DAMAGE HAZARD!**

- Monitor the polarity indicator lights *EVERY TIME* you connect to shore power.
- If a reversed polarity light turns *On* when you are connecting to shore power, do *NOT* turn *On* the main breaker switches.
- Instead, *IMMEDIATELY* unplug the shore power cord (*ALWAYS* from the dockside outlet first) and alert marina management.

1. Review *all* hazard information at the beginning of this section, *Shore Power*.
2. Turn *Off* the shore power master circuit breaker(s) and *all* switches and breakers on the 110-volt AC master panel.
3. Attach the shore power cord(s) to the boat inlet(s) first, then to the dockside outlet(s).
4. Turn *On* the SHORE POWER 1 and SHORE POWER 2 (if equipped) master breaker(s) on the 110-volt AC master panel.
5. As needed, turn *On* the individual component breakers on the 110-volt AC master panel.

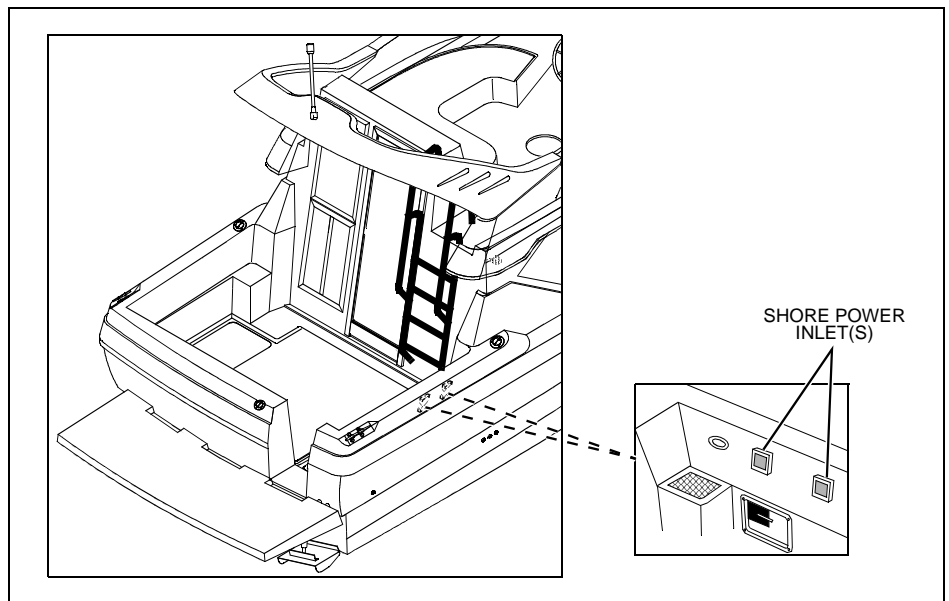

### Parallel Switch (Only if Equipped with Dual Shore Power)

**NOTICE**

- When using the parallel switch do *NOT* exceed 30 total amps.
- The amperage of each component breaker is shown on the breaker itself.
- The voltage on each line can be read on the voltmeter on the 110-volt AC master panel.

When only one dockside outlet is available, you can use the parallel switch to provide power to both lines.

1. Connect to shore power as described in the *Connecting to Shore Power* section above.
2. Switch the parallel switch (transfers power from line 1 to line 2) *On* instead of the SHORE POWER 2 master breaker.
3. Turn *On* the individual component breakers as required.

# Electrical Routings

## 110-Volt AC Hull Harnesses Routing System

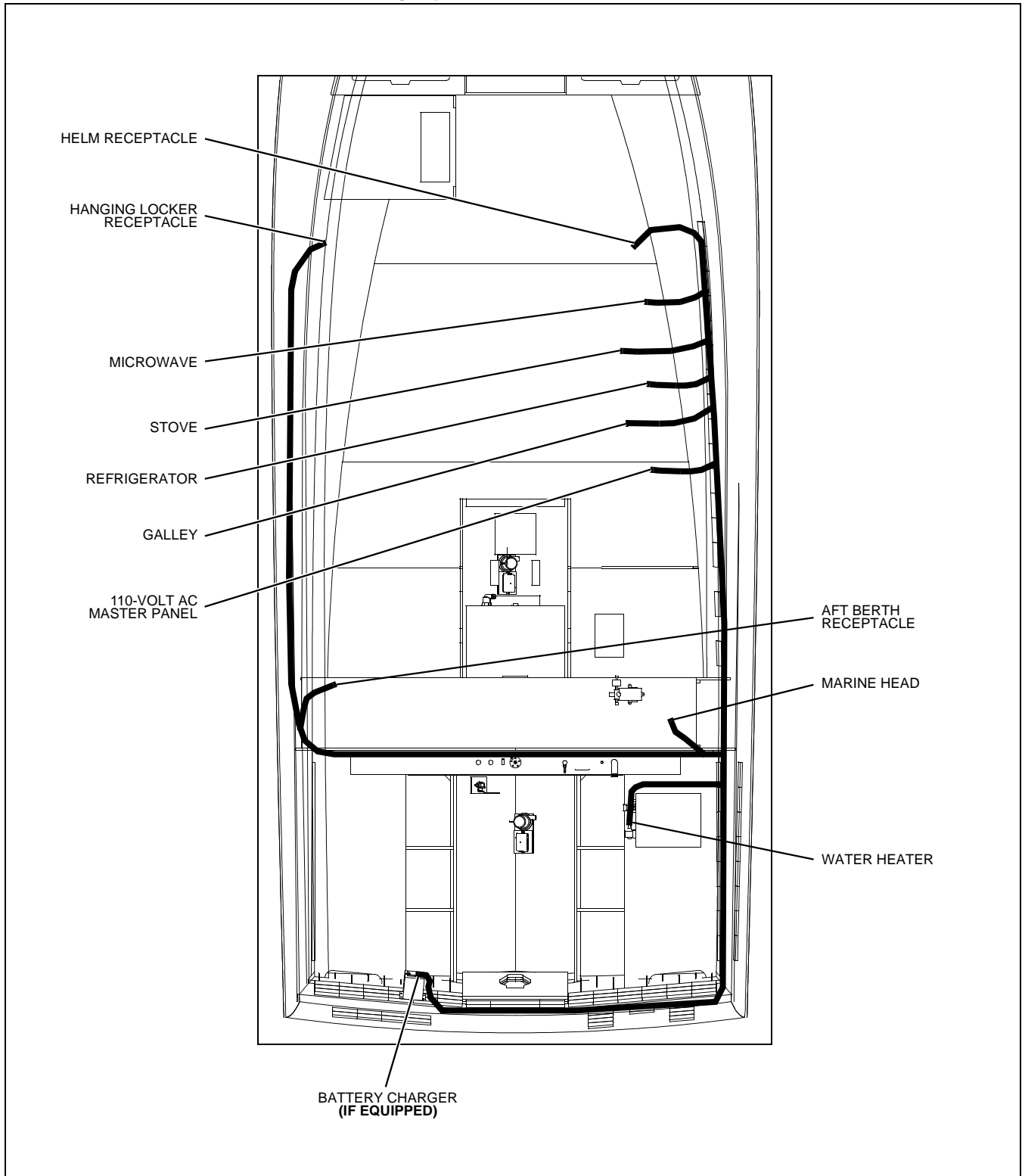

### 12-Volt DC Hull Harnesses Routing System

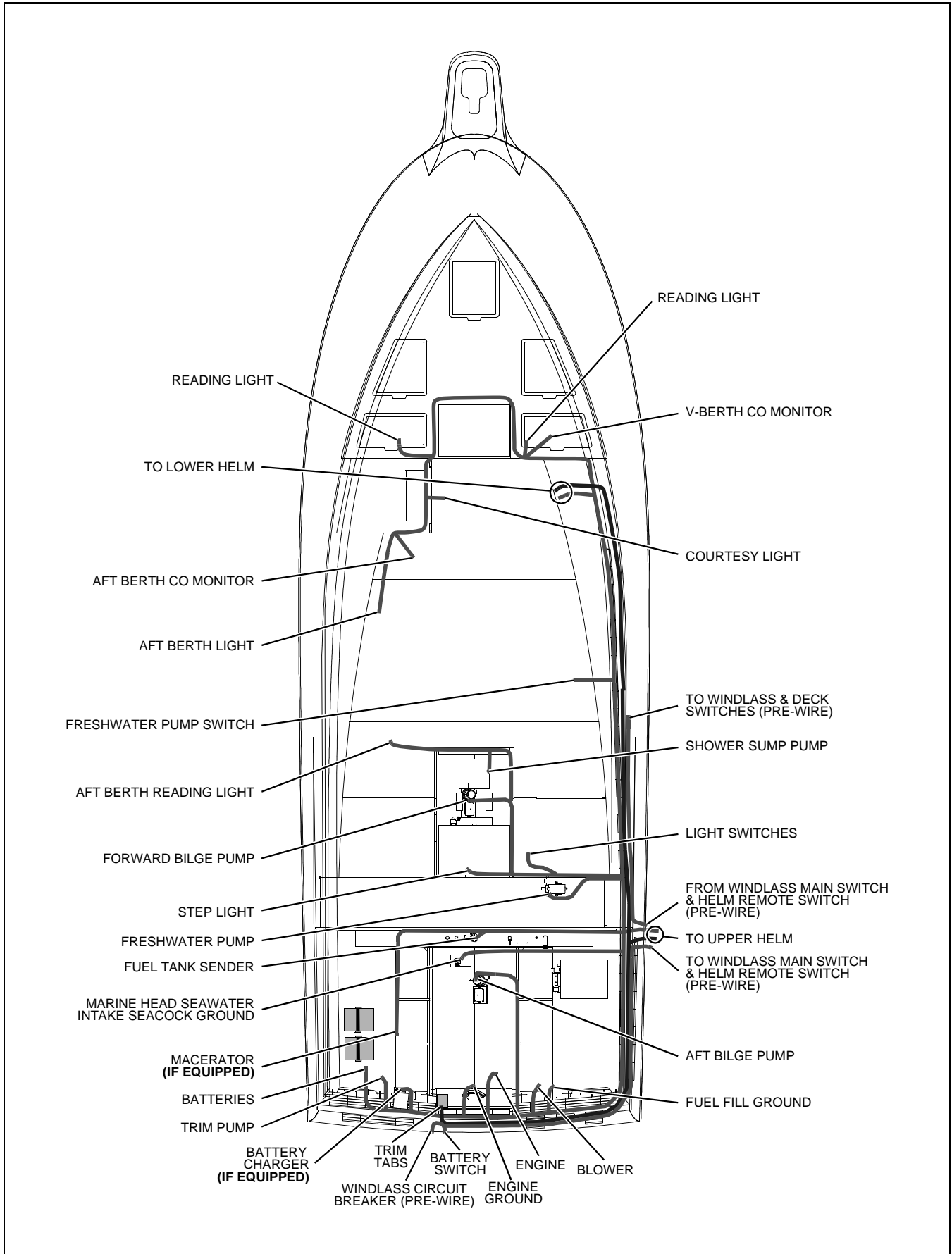

### 12-Volt DC Deck Harness Routings

NOTE: VIEW IS UNDERSIDE OF DECK

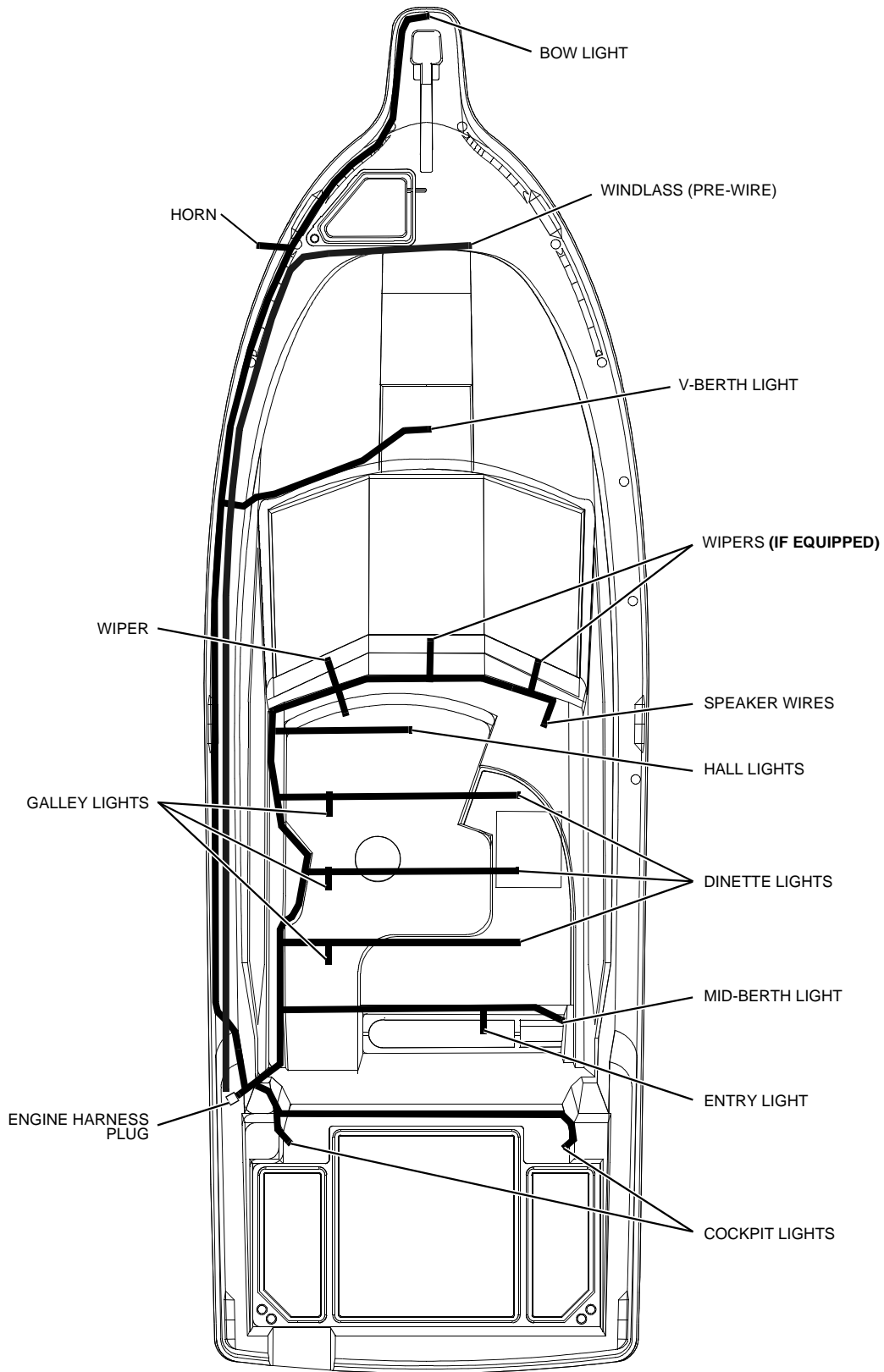

### Battery Cable Routings

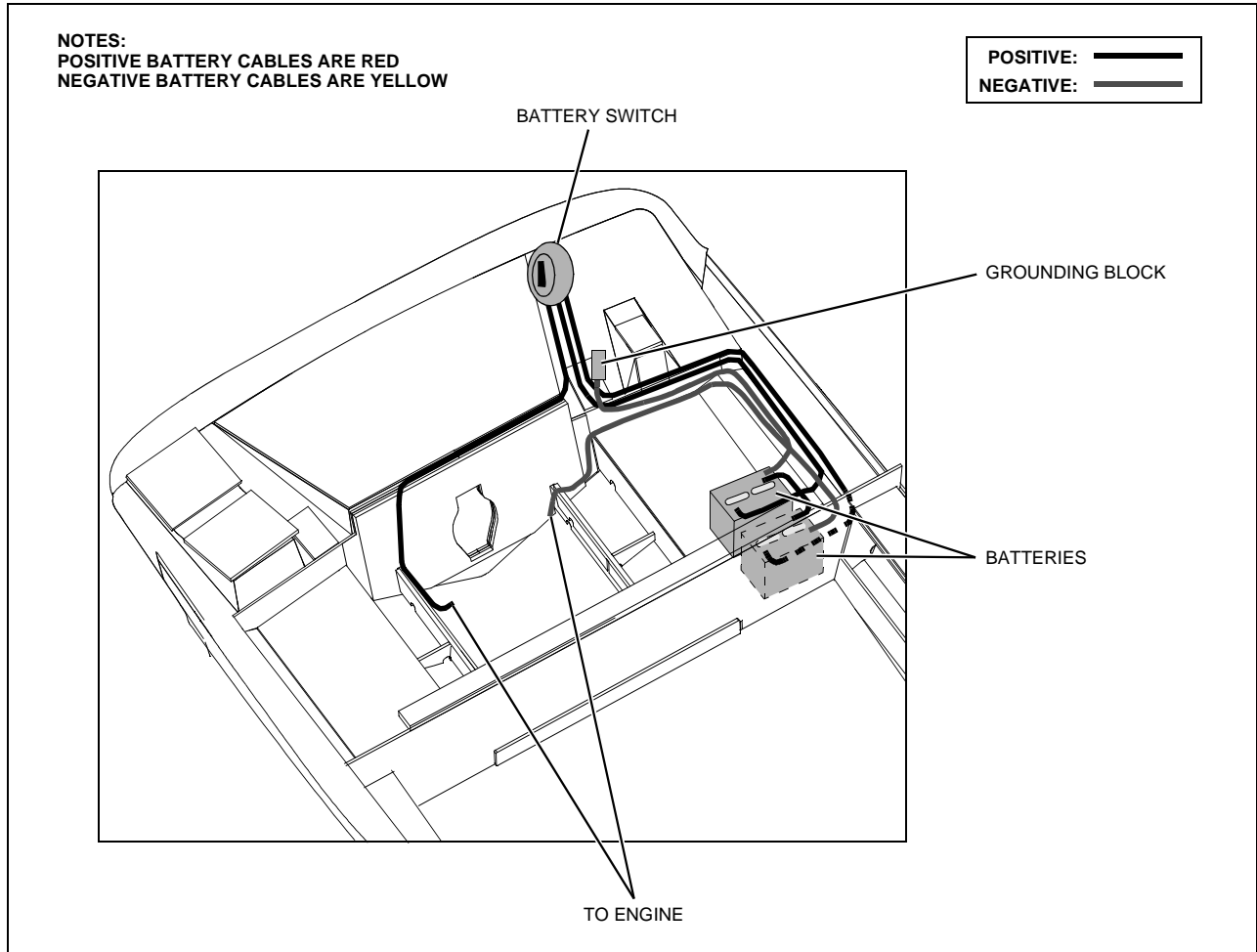

# Wiring Diagrams

## 110-Volt AC Electrical System Single Dockside

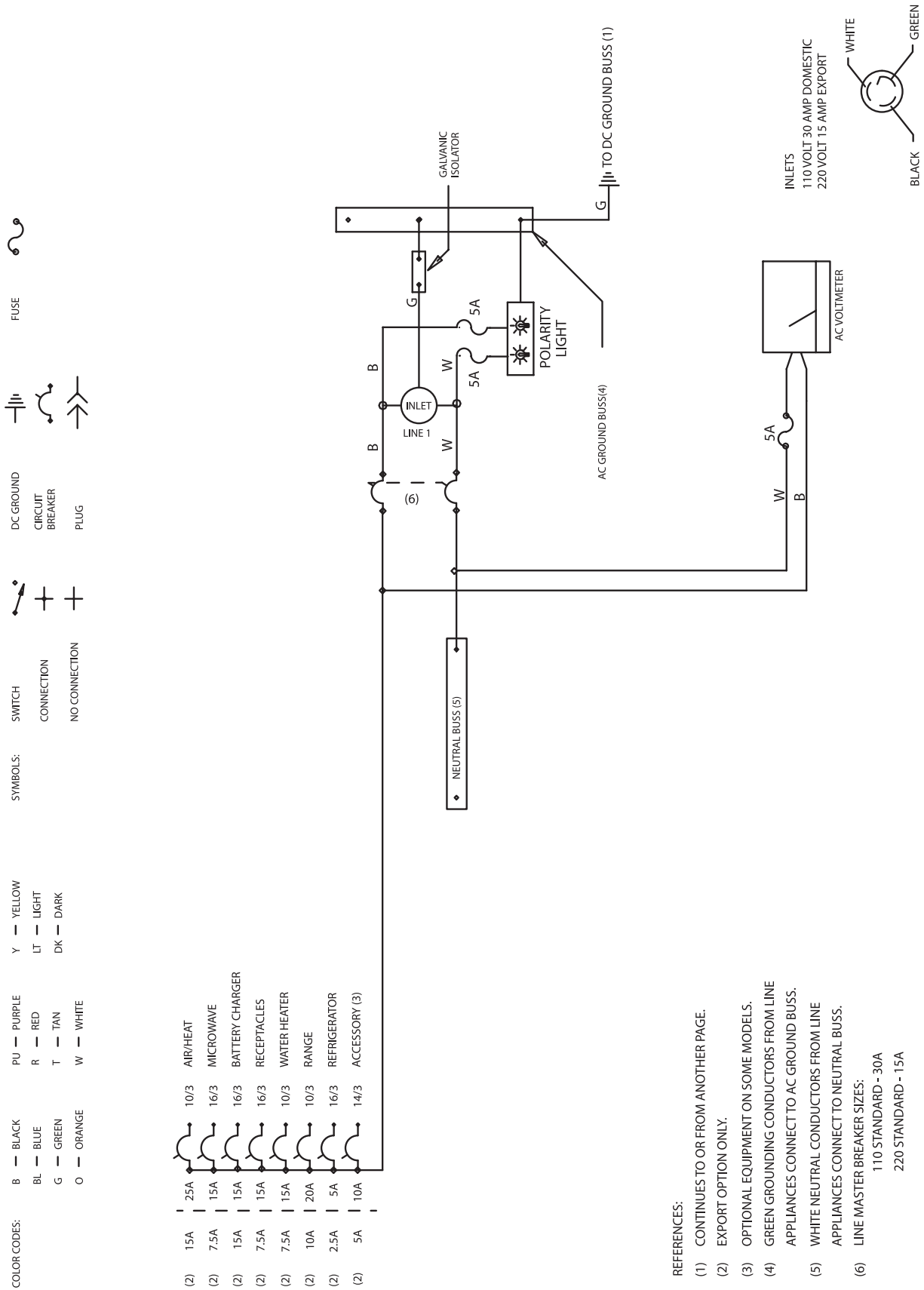

### 110-Volt AC Electrical System Dual Dockside

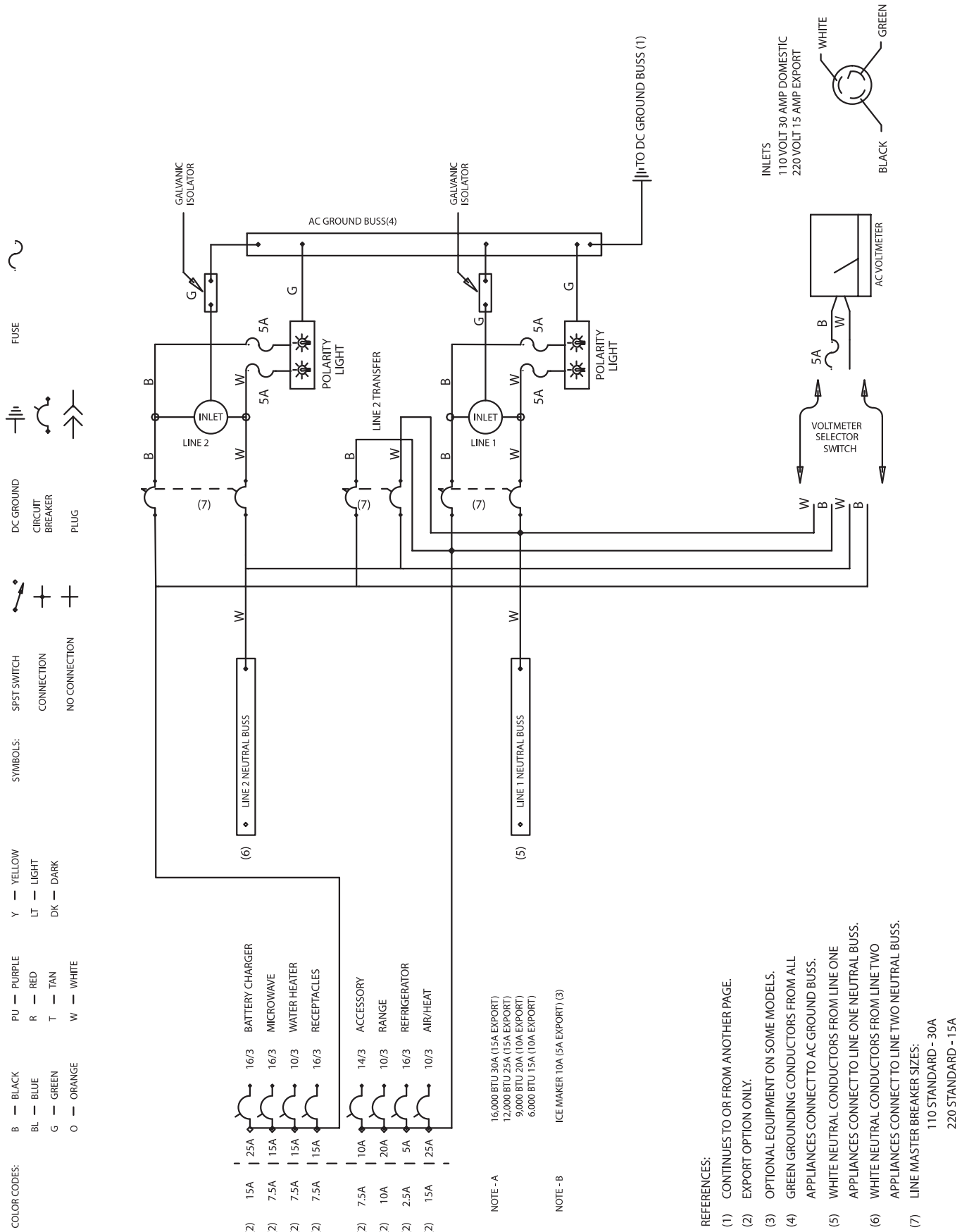

## ***Engine Electrical System***

**View not available at time of printing.  
Periodically check <http://www.bayliner.com> for updates.**



# Important Records

---

## Selling Dealer

\_\_\_\_\_  
Name Of Dealership

\_\_\_\_\_  
Address

\_\_\_\_\_  
Phone/FAX/E-mail

\_\_\_\_\_  
Sales Manager

\_\_\_\_\_  
Service Manager

## Engines

\_\_\_\_\_  
Engine Serial Number

\_\_\_\_\_  
Oil Type/SAE

\_\_\_\_\_  
Quarts per Engine

\_\_\_\_\_  
Filter Type

## Propeller

\_\_\_\_\_  
Manufacturer

\_\_\_\_\_  
Pitch

\_\_\_\_\_  
Model Number

## Generator

\_\_\_\_\_  
Manufacturer

\_\_\_\_\_  
Model Name/Number

\_\_\_\_\_  
Serial Number

\_\_\_\_\_  
Oil Type/SAE

\_\_\_\_\_  
Quarts

\_\_\_\_\_  
Filter Type

## Fuel System

\_\_\_\_\_  
Fuel Capacity

\_\_\_\_\_  
Filter Type

## Key Numbers

\_\_\_\_\_  
Ignition

\_\_\_\_\_  
Other

## Electronics

\_\_\_\_\_  
Manufacturer

\_\_\_\_\_  
Model Name/Number

\_\_\_\_\_  
Serial Number

\_\_\_\_\_  
Manufacturer

\_\_\_\_\_  
Model Name/Number

\_\_\_\_\_  
Serial Number

\_\_\_\_\_  
Manufacturer

\_\_\_\_\_  
Model Name/Number

\_\_\_\_\_  
Serial Number

\_\_\_\_\_  
Manufacturer

\_\_\_\_\_  
Model Name/Number

\_\_\_\_\_  
Serial Number

\_\_\_\_\_  
Manufacturer

\_\_\_\_\_  
Model Name/Number

\_\_\_\_\_  
Serial Number

## Float Plan

Before going boating, fill out a copy of this float plan (or similar) and leave it with a *reliable* person whom you can depend on to contact the Coast Guard or other rescue organization, if you do not return as scheduled.

### Description of Boat

Registration/Documentation Number		
Length	Make	Type
Hull Color		Trim Color
Fuel Capacity	Engine Type	Number of Engines
Distinguishing Features		
Distinguishing Features		

### Operator of Boat

Full Name		
Male or Female	Age	Health
Address		
Address		
Phone/FAX/E-mail		
Operator's Experience		

### Persons Onboard

Full Name		
Age	Health	Phone Number
Full Name		
Age	Health	Phone Number
Full Name		
Age	Health	Phone Number
Full Name		
Age	Health	Phone Number
Full Name		
Age	Health	Phone Number
Full Name		
Age	Health	Phone Number
Full Name		
Age	Health	Phone Number

## Survival Equipment

Marine Radio (Yes/No)	Type	Frequencies
Number of PFDs	Flares (Yes/No)	Mirror (Yes/No)
Smoke Signals (Yes/No)	Flashlight (Yes/No)	Food (Yes/No)
Water (Yes/No)	Anchor (Yes/No)	Raft/Dinghy (Yes/No)
Paddles (Yes/No)	EPIRB (Yes/No)	Other
Other	Other	Other

## Vehicle Description

Make	Model
Color	License Number
Where is the Vehicle Parked?	

## Trip Expectations

Departing From	
Departure Date	Departure Time
Stopover 1	
Arrive No Later Than: Date	Arrive No Later Than: Time
Stopover 2	
Arrive No Later Than: Date	Arrive No Later Than: Time
Stopover 3	
Arrive No Later Than: Date	Arrive No Later Than: Time
Stopover 4	
Arrive No Later Than: Date	Arrive No Later Than: Time
Stopover 5	
Arrive No Later Than: Date	Arrive No Later Than: Time
Stopover 6	
Arrive No Later Than: Date	Arrive No Later Than: Time
Final Destination Port (If Different Than Home Port)	
Arrive No Later Than: Date	Arrive No Later Than: Time

**If not returned by the date and time listed above, call the Coast Guard or other local authority.**

Coast Guard Phone Number
Local Authority Phone Number









**Part Number 1781925**

**Bayliner • P.O. Box 9029 • Everett, WA 98206 • 360-435-5571**