

BAYLINER®

Capri Runabouts

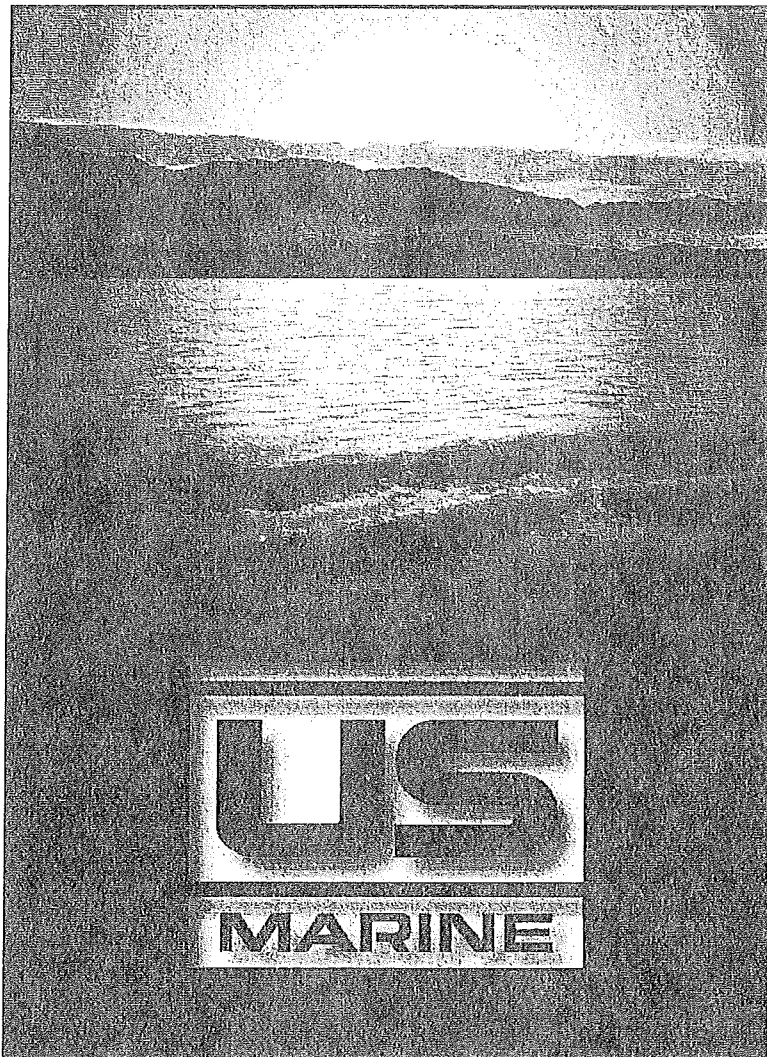

Owner's Manual Supplement



To Be The Best For Total Customer Satisfaction

Congratulations and welcome aboard your new Bayliner!

Thank you for choosing our product. Bayliner, a division of US Marine, is committed to the goal of building the highest quality products in the marine industry and to providing the finest after-the-sale support in the world.

To keep our respected status as the number one boat builder in the world, US Marine has instituted an ongoing *Total Customer Satisfaction Program*. The guiding principles of this program are:

- Design, build and support the finest marine products in the world, in every market we serve.
- Be personally and individually responsible for the customer's total satisfaction.
- Remember that every customer has a choice, and we want them to choose US Marine!

Welcome to the US Marine family. We are looking forward to serving your boating needs, now and in the future!

BAYLINER® a division of US Marine, a Brunswick Company

**The information in this Owner's Manual *Supplement* relates to
1999/2000 Bayliner Capri Runabouts**

Hull Identification Number _____

Engine Serial Number _____

Hull Identification Number:

The Hull Identification Number (HIN) is located on the starboard side of the transom.

Record the HIN and the engine serial number in the space provided above.

Refer to the HIN for any correspondence or orders.

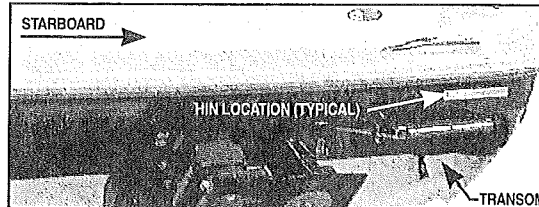

1999/2000

© 1998 Bayliner Technical Publications. All rights reserved.

No part of this publication may be reproduced, stored in any retrieval system, or transmitted in any form by any means, electronic, mechanical, photocopying, recording or otherwise, without prior written permission of Bayliner. Printed in the United States of America.

General Notes

The material in this document is for information only and is subject to change without notice. While reasonable efforts have been made in the preparation of this document to assure its accuracy, Bayliner assumes no liability resulting from errors or omissions in this document, or from the use of information contained herein.

Due to our commitment to product improvement, Bayliner reserves the right to make changes in the product design, specifications, and equipment at any time without notice or obligation.

All Bayliner products meet or exceed USCG and/or NMMA construction standards.

Illustrations and/or photos may show optional equipment.

Proprietary Rights

This document discloses subject matter in which Bayliner has proprietary rights. The information and design disclosed herein were originated by and are the property of Bayliner. Neither receipt nor possession thereof confers or transfers any right to reproduce, copy, alter or disclose the document or any part thereof, any information contained therein, or to construct boats or any item from it, except by written permission from or written agreement with Bayliner. This document is to be returned upon request to Bayliner.

Manufactured with 1,1,1-Trichloroethane, a substance which harms public health and environment (during the manufacturing process) by destroying ozone in the upper atmosphere.

CONTENTS

CHAPTER 1: ABOUT THIS MANUAL

- 1 Dealer Service
- 1 Boating Experience
- 1 Engine/Accessories Guidelines
- 2 Safety Standards
- 2 Qualified Maintenance
- 3 Hazard Warning Symbols

CHAPTER 2: PRODUCT SPECIFICATIONS

- 4 1750 (CH)
- 4 1800 (CJ)
- 5 1802 (CC)
- 5 1804 (PC)
- 6 1850 (BB)
- 6 1850 (CS)
- 7 1950 (CL)
- 7 1952 (CN)
- 8 1954 (CW)
- 8 2050 (CX)
- 9 2050 (CZ)
- 9 2052 (CK)
- 10 2350 (BC)
- 10 2350 (BD)
- 11 2352 (BF)

CHAPTER 3: COMPONENTS / SYSTEMS

- 12** Electrical System (12 Volt DC)
- 13** Accessory Fuse Block
- 14** Wiring Harnesses, Stern Drive Models
- 15** Wiring Harnesses, Stern Drive Fishing Models
- 16** Wiring Harnesses, Outboard Fishing Models
- 17** Wiring Harnesses, Outboard Models
- 18** Wiring Diagram, Outboard Models
- 19** Wiring Diagram, Outboard Fishing Models
- 20** Wiring Diagram, Stern Drive Models
- 21** Wiring Diagram, Stern Drive Fishing Models
- 22** Controls
- 22** Navigation and Interior Lights
- 22** Compass
- 23** Depth Finder
- 23** Bow Mount Trolling Motor
- 23** Anchoring
- 24** Ski Pylon
- 24** Hull Exterior Drains & Hardware
- 25** Fuel System
- 25** Bilge Blower
- 27** Live Well System
- 28** Bilge Pump
- 30** Fresh Water System
- 31** Marine Head With Pump Out
- 31** Portable Toilet
- 32** Alcohol Stove
- 33** Aft Jump Seat Conversion
- 34** Sleeper Seat Adjustment
- 34** Pedestal Seats
- 35** Canvas Top Installation
- 36** Canvas Stowage

CHAPTER 4: ISO SYMBOLS

- 37** Definitions

LIMITED WARRANTY

- 41** What Is Not Covered
- 41** Other Limitations
- 41** Your Obligation

CHAPTER 1: ABOUT THIS MANUAL

This Owner's Manual Supplement was prepared to provide specific information about your boat. Please study the Owner's Manual and this supplement carefully, paying particular attention to the LIMITED WARRANTY section.

Keep this supplement in a secure place and hand it over to the new owner when you sell the boat.

Dealer Service

Make certain that you receive a full explanation of all systems from the selling dealer before taking delivery of your boat. Your selling dealer is your key to service. If you experience any problems with your new boat, immediately contact the selling dealer. If for any reason your selling dealer is unable to help, you can call us direct on our customer service hotline:

360-435-8957 or send us a FAX: 360-403-4235

Boating Experience

If this is your first boat or if you are changing to a type of boat you are not familiar with, for your own comfort and safety, please ensure that you obtain handling and operating experience before assuming command of the boat. Your selling dealer, national sailing federation or yacht club will be pleased to advise you of local sea schools, or competent instructors.



- A qualified operator must be in control of the boat at all times.
- Do not operate your boat while under the influence of alcohol or drugs.

Engine/Accessories Guidelines

Your boat's engine (or engines) and accessories were selected to provide optimum performance and utility. Installation of different engines or other accessories may cause undesirable handling characteristics. Should you choose to install different engines, or to add accessories that will affect the boat's running trim, have an experienced marine technician perform a safety inspection and a handling test before operating your boat by yourself again.

Safety Standards

Your boat's mechanical and electrical systems were designed to meet safety standards in effect at the time it was constructed. Some of these standards were mandated by law. All of them were designed to insure your safety, and the safety of other people, vessels and property.



PERSONAL SAFETY HAZARD - *Do not* allow anyone to ride on parts of the boat that were not designated for such use:

Sitting up on the seat backs, bow riding, gunwale riding, occupying the transom platform or the aft sundeck cushions while underway is especially hazardous and will cause personal injury or death.

Please read the Owner's Manual, warning labels and all literature supplied with your boat for important safety standards and hazard information.

Qualified Maintenance



To maintain the integrity and safety of your boat, only qualified people should perform maintenance on, or in any way modify; the steering system, propulsion system, engine control system, fuel system, environmental control system, or electrical system.

Failure to maintain these systems as designed could violate the laws in your jurisdiction, and could expose you and other people to the danger of bodily injury or accidental death. We recommend that you follow the instructions provided in this supplement, the Owner's Manual, the engine owner's manual, and the accessory instruction sheets included with your boat.

Hazard Warning Symbols

The hazard warning symbols shown below are used throughout this supplement to call attention to potentially dangerous situations which could lead to either personal injury or product damage. We urge you to read these warnings carefully and follow all safety recommendations:



This symbol alerts you to immediate hazards which ***WILL*** cause severe personal injury or death if the warning is ignored.



This symbol alerts you to hazards or unsafe practices which ***COULD*** result in severe personal injury or death if the warning is ignored.



This symbol alerts you to hazards or unsafe practices which ***COULD*** result in minor personal injury, or cause product or property damage if the warning is ignored.



This symbol calls attention to installation, operation, or maintenance information which is important to proper operation, but is not hazard-related.



**Fire and/or
Explosion Hazard!**



**Rotating Propeller
Hazard!**



**Personal Injury
Hazard!**



**Open Flame
Hazard!**

CHAPTER 2: PRODUCT SPECIFICATIONS

1750 (CH)

Overall Length	Bridge Clearance	Beam	Maximum Draft	Fuel Tank Capacity (gal)
17' 7"	3' 10"	6' 11"	2' 8"	23

1800 (CJ)

Overall Length	Bridge Clearance	Beam	Maximum Draft	Fuel Tank Capacity (gal)
17' 7"	3' 10"	6' 11"	2' 8"	23

1802 (CC)

The deck plan for the Bayliner 1802 (CC) shows a layout with two 'SLEEPER SEATS' positioned on either side of a central 'STOWAGE' area. At the bow (front) of the boat, there is a 'V-BERTH' area. The stern (back) features a transom with a swim platform.

Overall Length	Bridge Clearance	Beam	Maximum Draft	Fuel Tank Capacity (gal)
17' 7"	4' 5"	6' 11"	2' 8"	23

1804 (PC)

The deck plan for the Bayliner 1804 (PC) shows a layout with two 'ADL BUCKET' locations on either side of a central 'STOWAGE' area. At the stern (back), there is a 'LIVWELL UNDER' area. The bow (front) features a transom with a swim platform.

Overall Length	Bridge Clearance	Beam	Maximum Draft	Fuel Tank Capacity (gal)
17' 7"	3' 10"	6' 11"	2' 8"	23

1850 (BB)

Overall Length	Bridge Clearance	Beam	Maximum Draft	Fuel Tank Capacity (gal)
18' 4"	3' 10"	7' 5"	2' 10"	30

1850 (CS)

Overall Length	Bridge Clearance	Beam	Maximum Draft	Fuel Tank Capacity (gal)
18' 4"	3' 10"	7' 5"	2' 10"	30

1950 (CL)

Overall Length	Bridge Clearance	Beam	Maximum Draft	Fuel Tank Capacity (gal)
18' 8"	3' 1"	7' 6"	2' 10"	25

1952 (CN)

Overall Length	Bridge Clearance	Beam	Maximum Draft	Fuel Tank Capacity (gal)
18' 8"	3' 8"	7' 6"	2' 10"	25

1954 (CW)

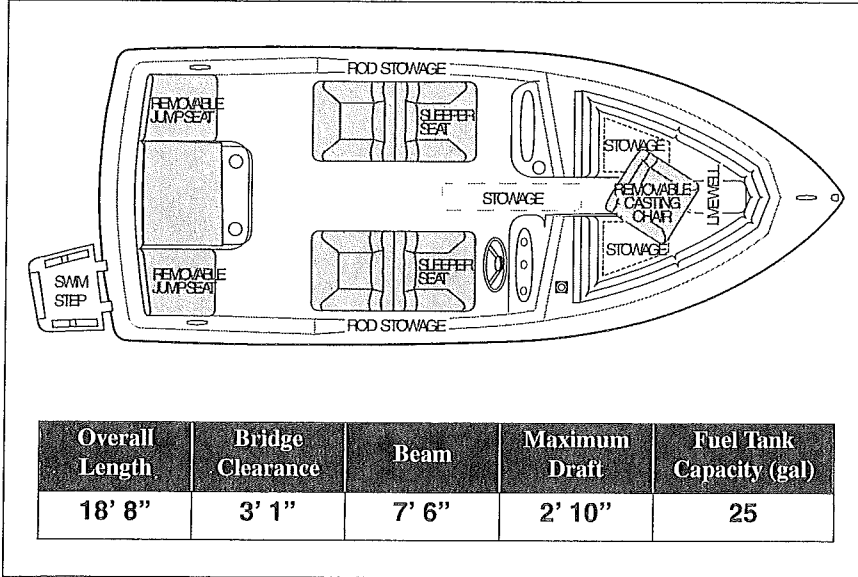

2050 (CX)

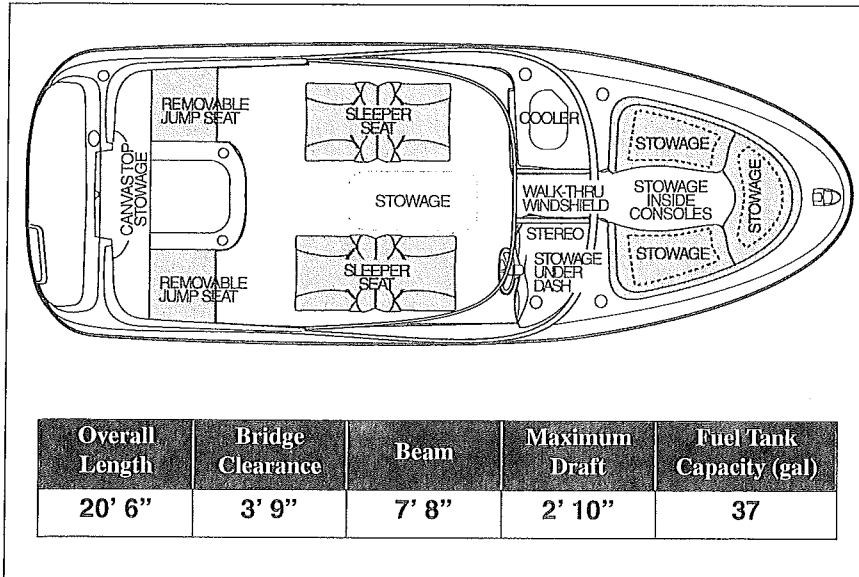

2050 (CZ)

Overall Length	Bridge Clearance	Beam	Maximum Draft	Fuel Tank Capacity (gal)
20' 6"	3' 9"	7' 8"	2' 10"	37

2052 (CK)

Overall Length	Bridge Clearance	Beam	Maximum Draft	Fuel Tank Capacity (gal)
20' 6"	4' 4"	7' 8"	2' 10"	37

2350 (BC)

LAYOUT VIEW NOT AVAILABLE
AT TIME OF PRINTING

Overall Length	Bridge Clearance	Beam	Maximum Draft	Fuel Tank Capacity (gal)
23' 9"	4' 8"	8' 6"	3' 0"	65

2350 (BD)

LAYOUT VIEW NOT AVAILABLE
AT TIME OF PRINTING

Overall Length	Bridge Clearance	Beam	Maximum Draft	Fuel Tank Capacity (gal)
23' 9"	4' 8"	8' 6"	3' 0"	65

2352 (BF)

LAYOUT VIEW NOT AVAILABLE
AT TIME OF PRINTING

Overall Length	Bridge Clearance	Beam	Maximum Draft	Fuel Tank Capacity (gal)	Optional Water Tank Capacity (gal)
23' 9"	*	8' 6"	*	65	11

* Measurements unavailable at time of printing

CHAPTER 3: COMPONENTS / SYSTEMS

Electrical System (12 Volt DC)

We strongly recommend that you read and understand the Electrical section of the Owner's Manual.



EXTREME HAZARD - To minimize the risks of fire and explosion, *NEVER* install knife switches or other arcing devices in fuel compartments.



EXTREME HAZARD - *NEVER* substitute automotive parts for marine parts. Electrical, ignition and fuel system parts were designed and manufactured to comply with rules and regulations to minimize risks of fire and explosion.

DO NOT modify the electrical systems or relevant drawings.



FIRE/EXPLOSION HAZARD - Only qualified personnel should install batteries and perform electrical system maintenance.



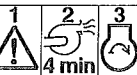

FIRE/EXPLOSION HAZARD - Minimize the danger of fire and explosion by not exposing the batteries to open flame or sparks. It is also important that no one smoke anywhere near the batteries.





FIRE/EXPLOSION HAZARD - Fuel fumes are heavier than air and they will collect in the bilge areas where they can be accidentally ignited. Visually and by

smell (sniff test), check the engine and fuel compartments for fumes or accumulation of fuel. If so equipped, operate the bilge blower for at least four minutes prior to engine starting, electrical system maintenance, or activation of electrical devices.

 **Never disconnect the battery cables while the engine is running, as this can cause damage to your boat's electrical system components.**

 **The battery charging systems (alternator and, if applicable, battery charger) installed are designed to charge conventional lead-acid batteries. Before installing gel-cell or other new technology batteries, consult with the battery manufacturer about charging system requirements.**

 **Electrical connections are prone to corrosion. Minimize electrical problems due to corrosion. Keep all exposed electrical connections clean and protect them with a spray-on protectant such as Corrosion Guard®.**

 **VOLTAGES - All boats use either 110-volt AC/60 Hertz, 240-volt AC/60 Hertz or 220-volt AC/50 Hertz single phase systems, and 12-volt DC or 24-volt DC. Electrical distribution panels are labeled with voltage and frequency of AC and DC.**

Accessory Fuse Block

Please read the electrical section of the Owner's Manual for important safeguards concerning your boat's fuse block.

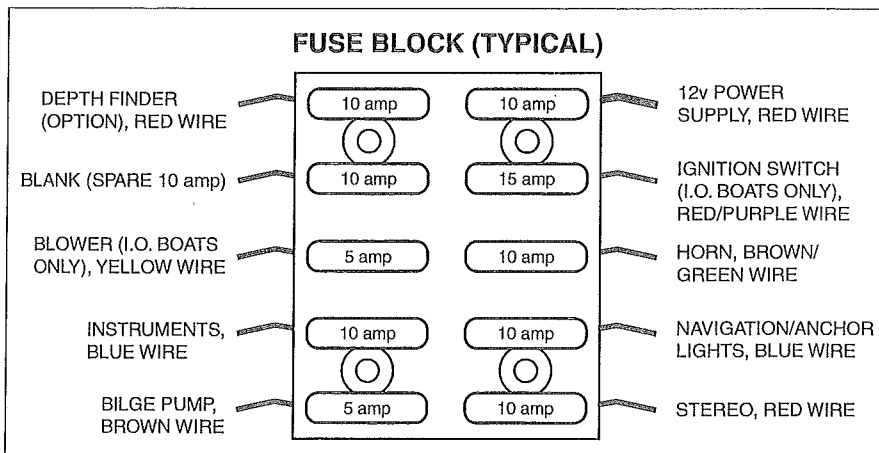

Wiring Harnesses, Stern Drive Models

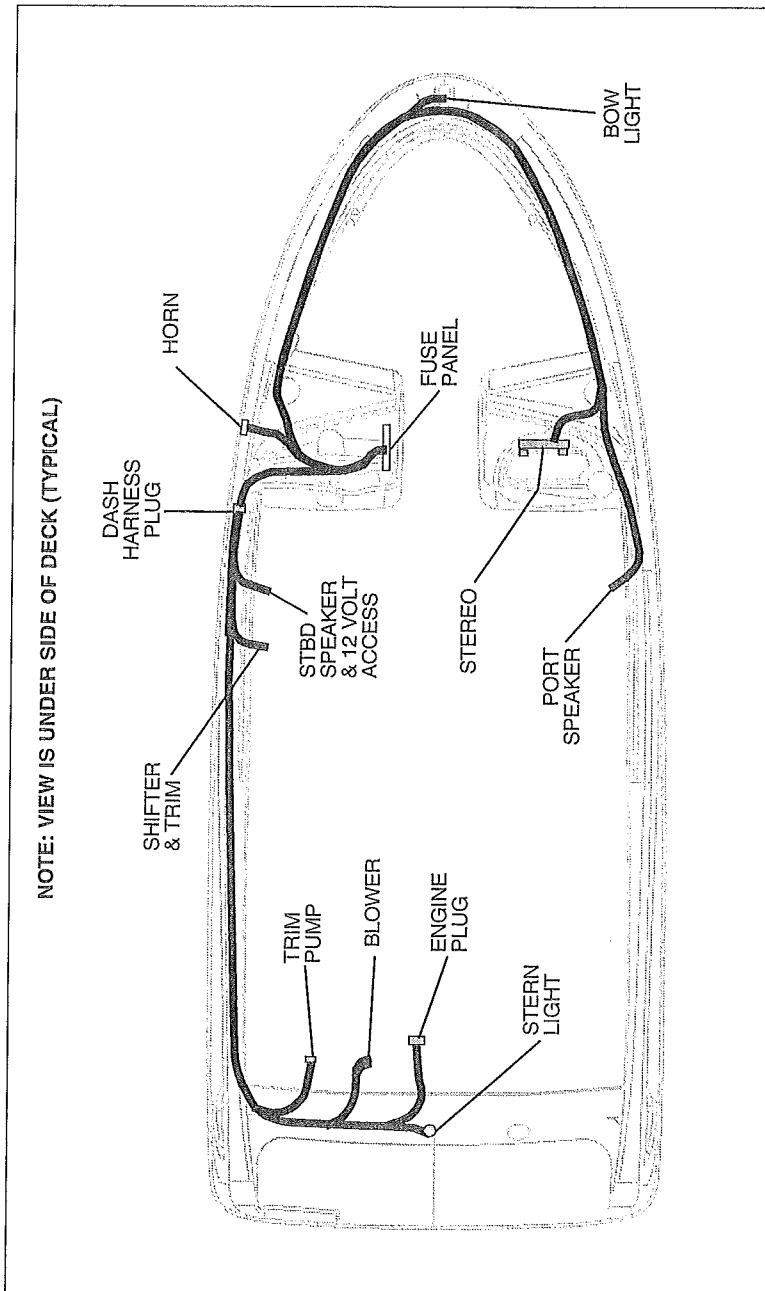

Wiring Harnesses, Stern Drive Fishing Models

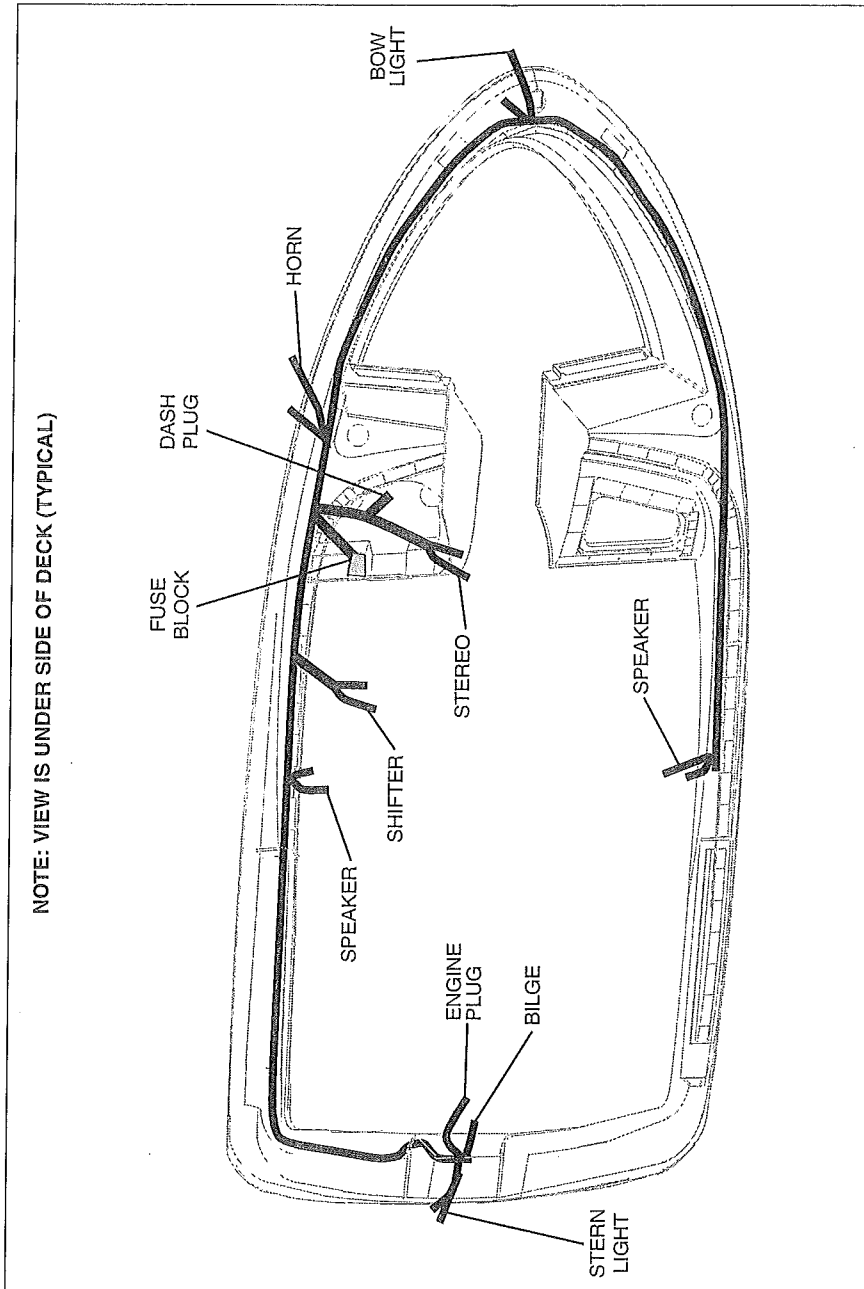

Wiring Harnesses, Outboard Fishing Models

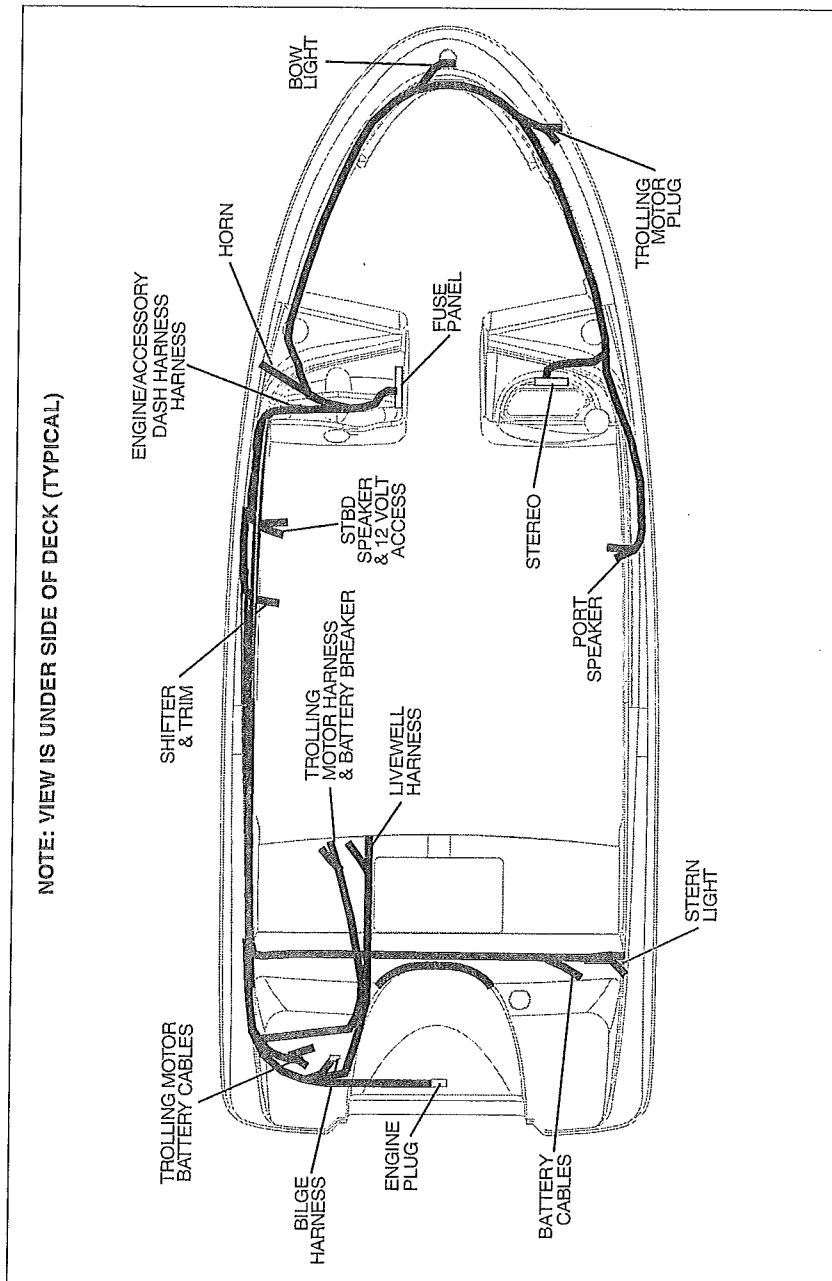

Wiring Harnesses, Outboard Models

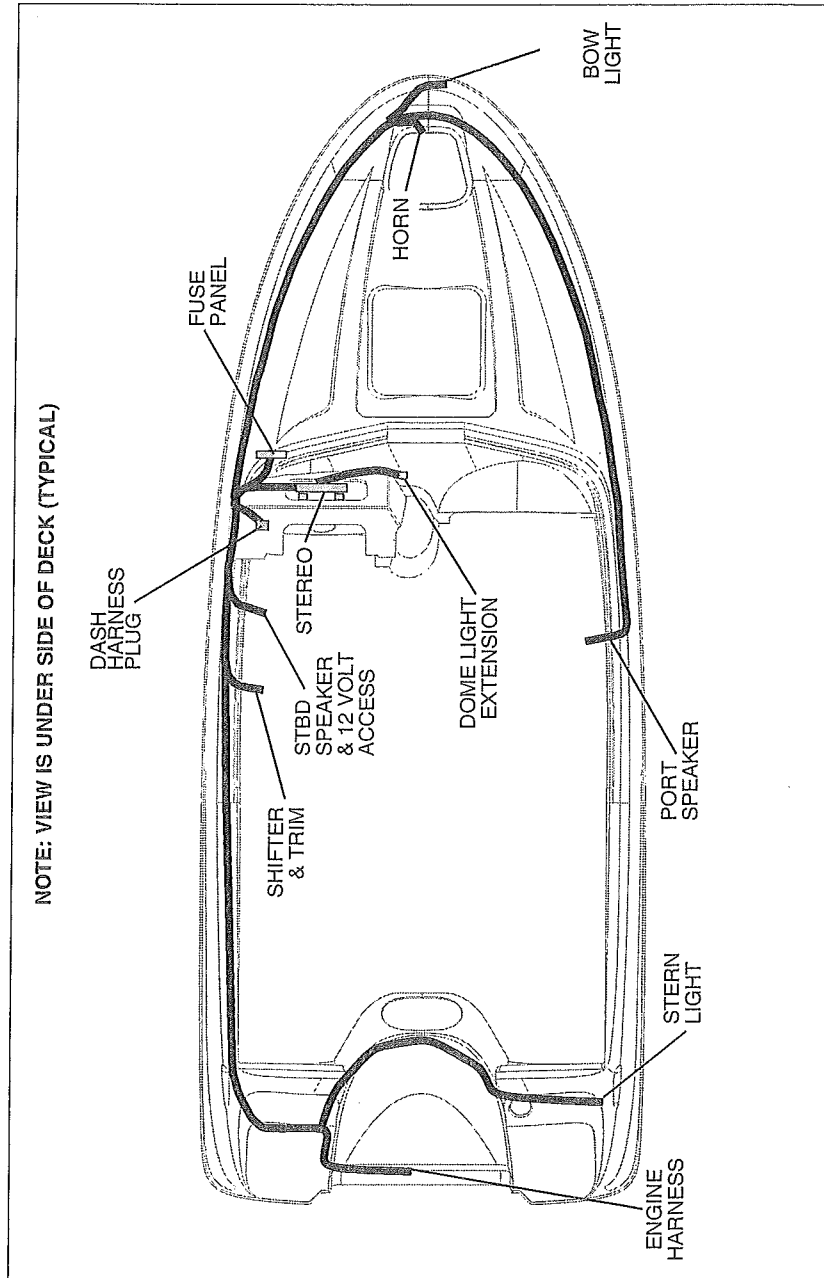



Wiring Diagram, Outboard Models

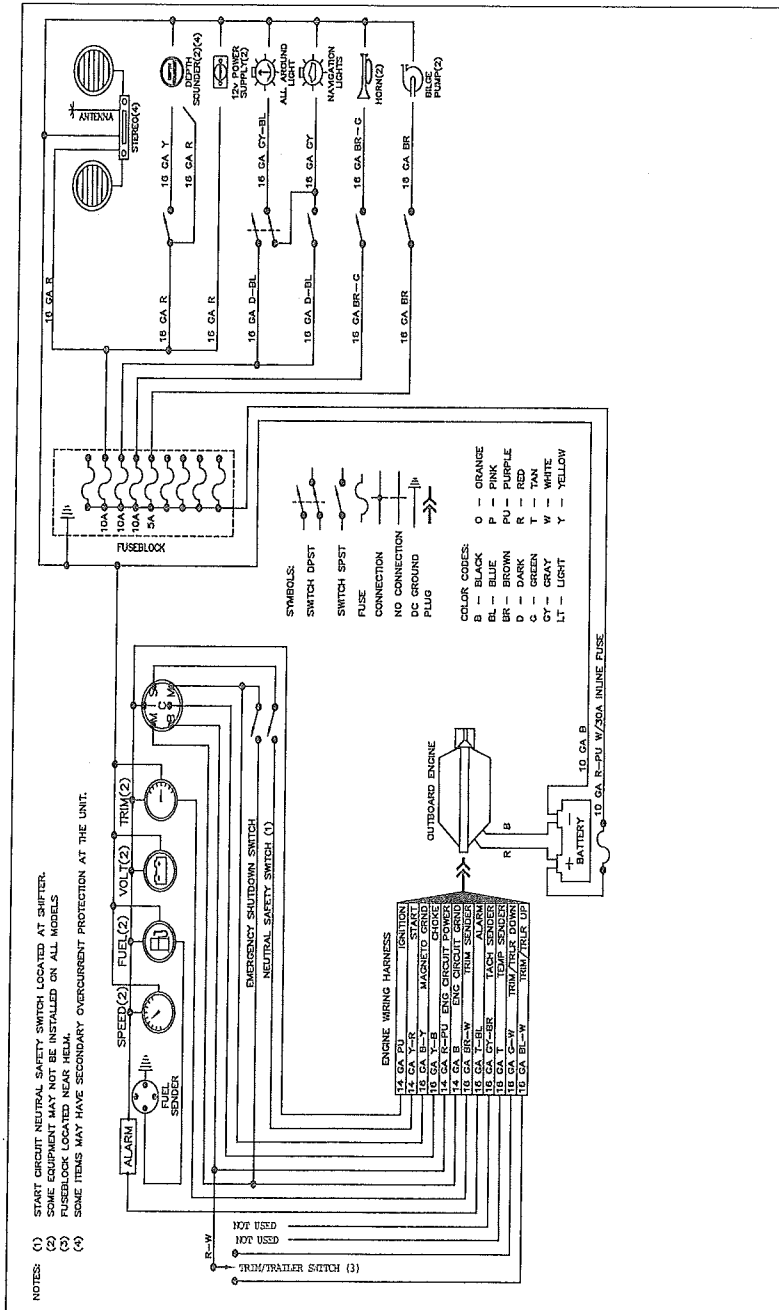

Wiring Diagram, Outboard Fishing Models

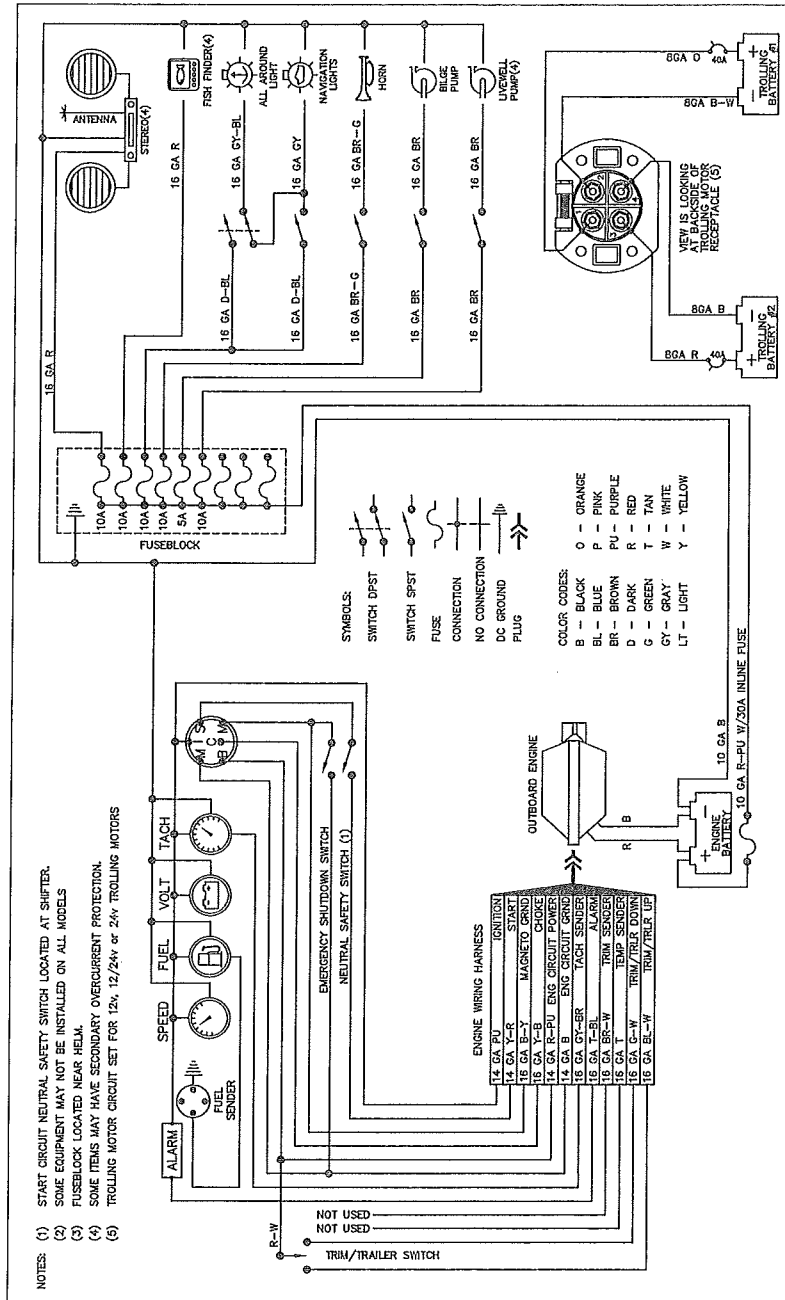



Wiring Diagram, Stern Drive Models

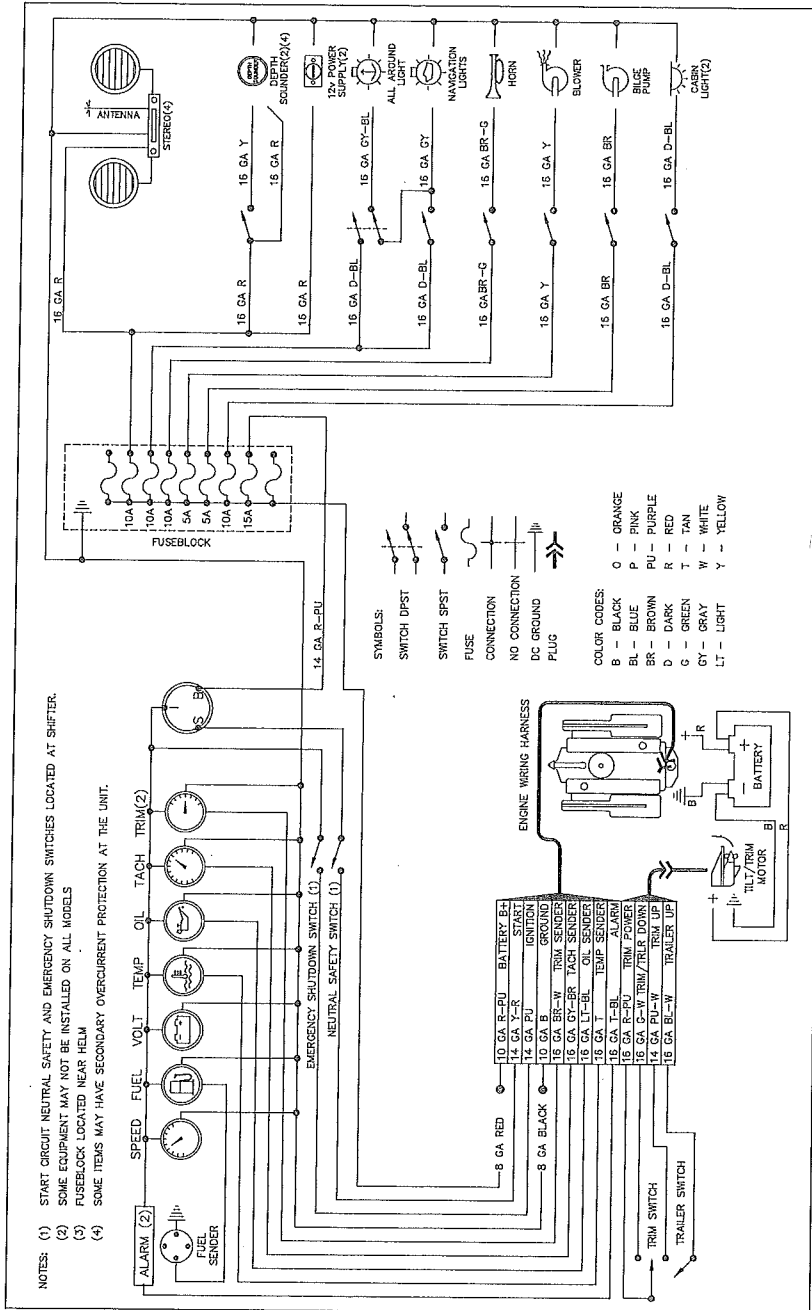

Wiring Diagram, Stern Drive Fishing Models

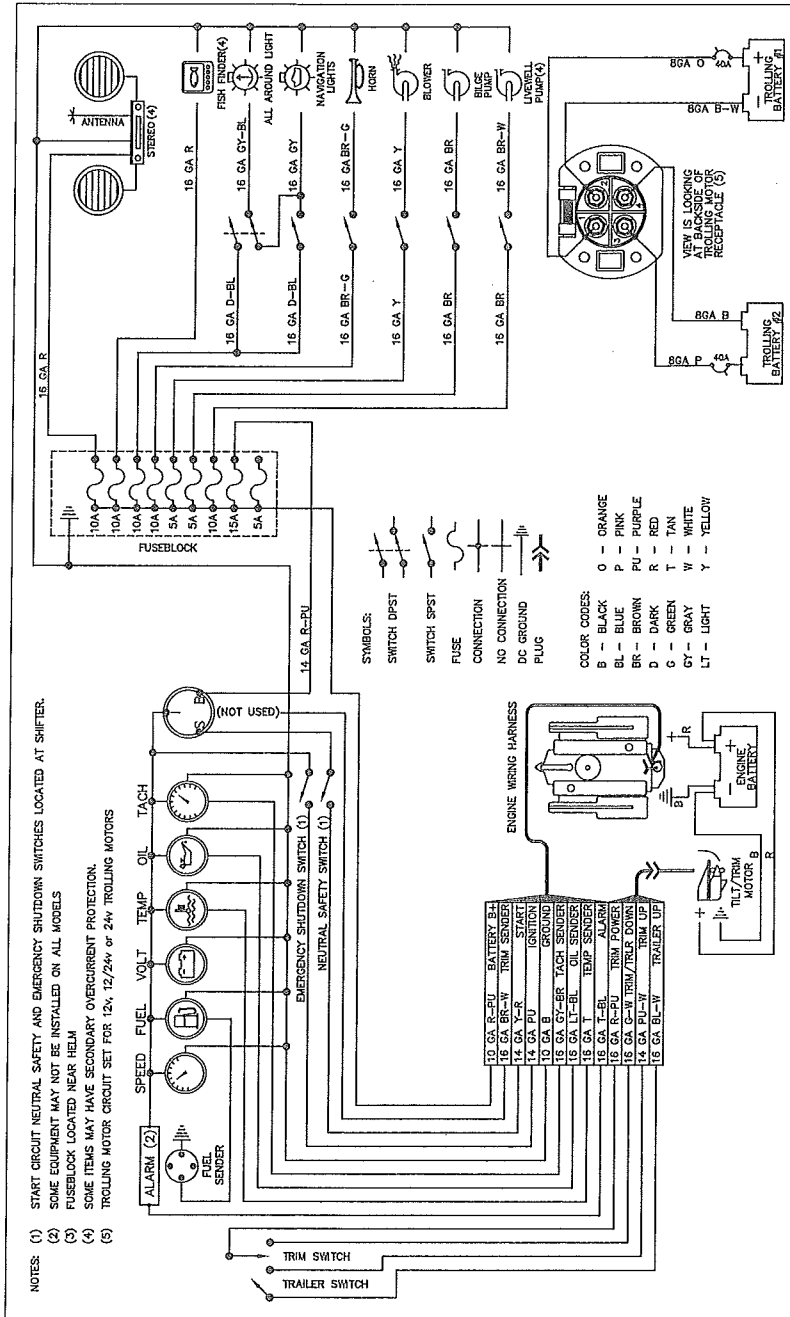

Controls

We strongly recommend that you read and understand the Controls section of the Owner's Manual and engine manual, provided in the owner's packet, for instructions and warranty information.

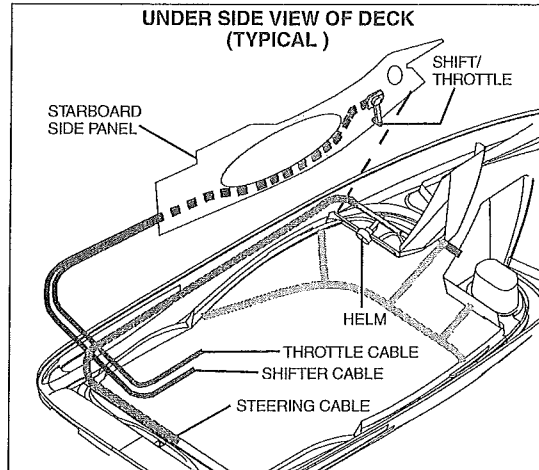

Navigation and Interior Lights

We strongly recommend that you understand navigation light usage as outlined in the Navigation section of the Owner's Manual. The navigation and interior lights supplied with your boat are of top quality, but may periodically fail for a variety of reasons:

1. There may be a blown fuse (Replace the fuse in the switch panel).
2. The bulb may be burned out (Carry spare bulbs for replacement).
3. The bulb base may be corroded (Clean the base periodically and coat it with non-conductive grease).
4. A wire may have come loose or may be damaged (Repair as required).



- **Avoid the storage of gear where it would block navigation lights from view.**
- **Prolonged operation of cabin interior lights (overnight) will result in a drained battery. Be conservative in the use of battery power.**

Compass

Your boat may come equipped with a compass. Carefully read and follow the manufacturer's calibration and operating instructions provided in the owner's packet.

Depth Finder

Your boat may come equipped with a depth finder. It will provide you with measurements of water depth beneath the boat and in many cases it may help you locate schools of fish. The depth finder comes with its own owner's manual. We suggest that you read it carefully before using the unit.



DO NOT use the depth finder as a navigational aid to prevent collision, grounding, boat damage or personal injury. When the boat is moving, submerged objects will not be seen until they are already under the boat. Bottom depths may change too quickly to allow time for the boat operator to react. If you suspect shallow water or submerged objects, operate the boat at very slow speeds.

Bow Mount Trolling Motor

Your boat may be equipped with a foot operated trolling motor. Usage instructions can be found in the owner's packet. We strongly recommend that you thoroughly read these instructions before using the trolling motor.

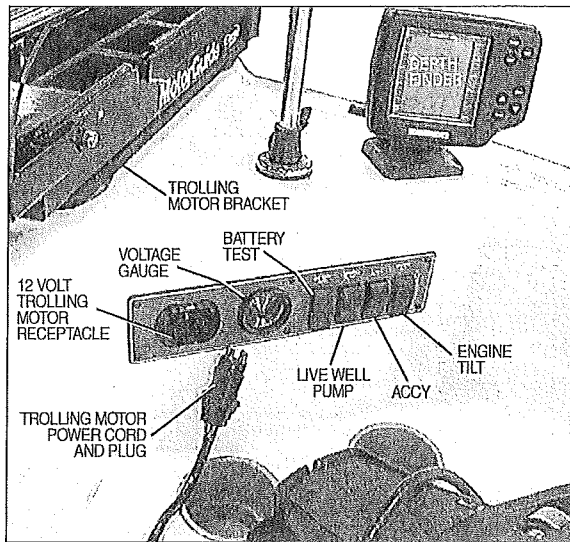

Anchoring

We strongly recommend that you read and understand the Anchoring section of the Owner's Manual.



FLOODING AND SWAMPING HAZARD - Never anchor by the stern alone--there is less freeboard and flooding or swamping is more likely to occur. When using only one anchor, secure the anchor line to the bow cleat or bow eye.

Ski Pylon

If your boat features a ski pylon, we strongly recommend that you carefully read the manufacturer's operating instructions included in your owner's packet *before* using the ski pylon. Carefully observe the following warnings:

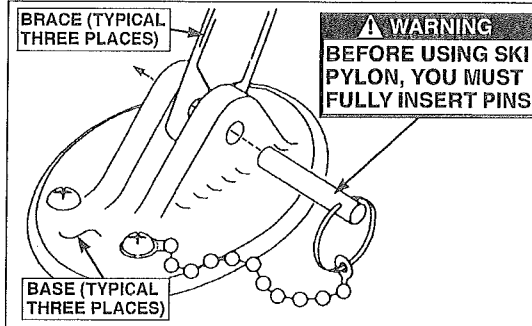

It is critical that all pins are fully inserted through the pressure plates, base plates and tow bar tubes. Improper insertion may cause injury or death.



When the tow bar is in use, all passengers must sit forward of the ski pylon and keep their hands well clear of the pylon and rope. Failure to do so may result in injury or death.

Hull Exterior Drains & Hardware

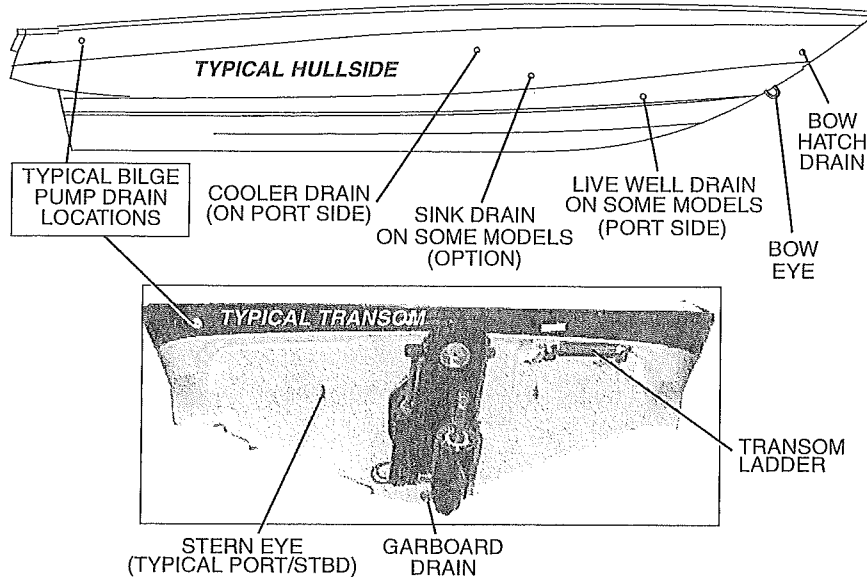

Fuel System

Fuel Fills and Vents

Fuel fills are located either on the aft deck or on the side decks adjacent to the aft cockpit. Fuel receptacle caps are marked "GAS". Fuel vents are normally located in the hull or transom below and in the same general area as the fill. If you experience difficulty filling the fuel tank, check to see that the fuel fill and vent lines are free of obstructions and kinks.

Fuel Filters

Fuel filters should be replaced periodically to ensure that they remain clean and free of debris. A fine mesh screen filter is located on the fuel pickup tube. An additional filter, when supplied by the engine manufacturer, is installed on the engine.

Consult your selling dealer or local marina concerning fuel additives that help to prevent fungus or buildup in your fuel tanks.

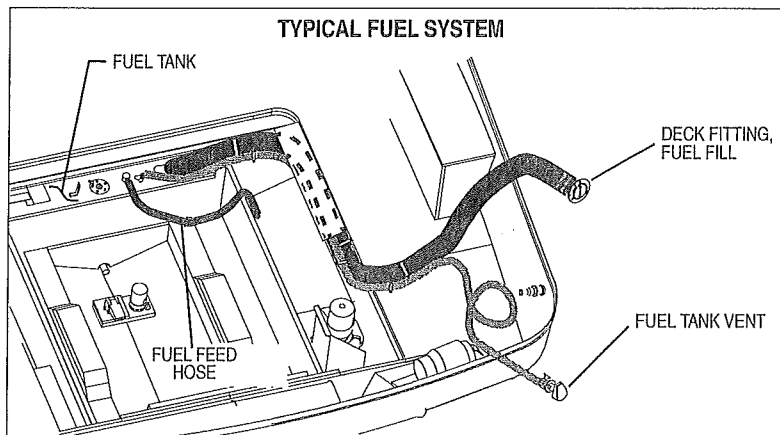

FIRE/EXPLOSION HAZARD - It is very important that the fuel system be inspected thoroughly the first time it is filled and then at each subsequent filling. For your safety and the safety of your passengers, the fueling instructions in the Owner's Manual must be followed.



Avoid the storage or handling of gear near the fuel lines, fittings and tank.

Bilge Blower

The bilge blower removes fumes from the engine compartment and draws fresh air into the compartment through the deck vents.

To ensure fresh air circulation, operate the bilge blower for at least four minutes before starting the engine, during starting, and while operating the boat below cruising speed.

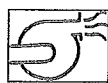
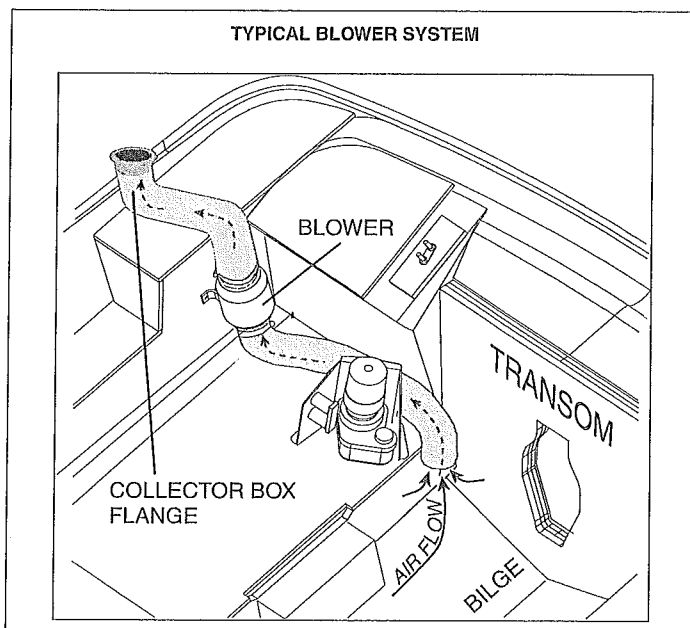

Operation of the blower system is **NOT A GUARANTEE** that explosive fumes have been removed. If you smell any fuel, **DO NOT** start the engine.

If the engine is already running, immediately shut off the engine and all electrical accessories. Investigate immediately. **DO NOT** obstruct or modify the ventilation system.

Live Well System

Your boat may feature a live well. The live well aerator pump(s) are located aft, adjacent to the bilge pump. The live well intakes are through-transom. The live well aerator pump(s) are located aft, adjacent to the bilge pump. The live well intakes are through-transom.

Switches for the live well are located on the forward electrical panel and on the main dash panel. These switches activate the aerator that pumps a continuous supply of fresh water into the live well. The overflow is automatically drained overboard.

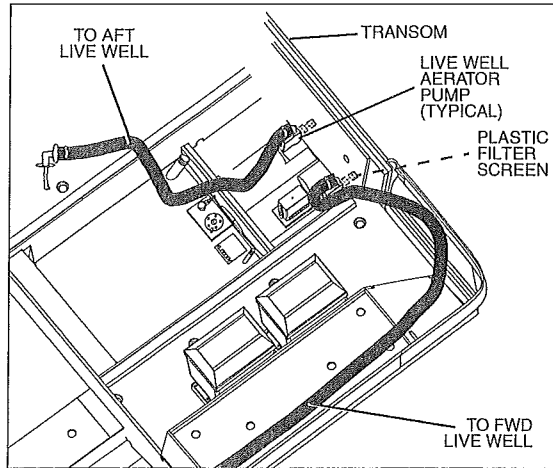

It is advisable to occasionally check the live well when it is operating to see that the aerator is pumping adequate amounts of water. If there appears to be a problem, check the system, including the plastic screens over the transom intakes for weeds or other debris.

The livewell is drained by removing the stand pipe (see photos to right) and allowing water to drain completely.

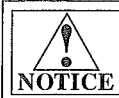
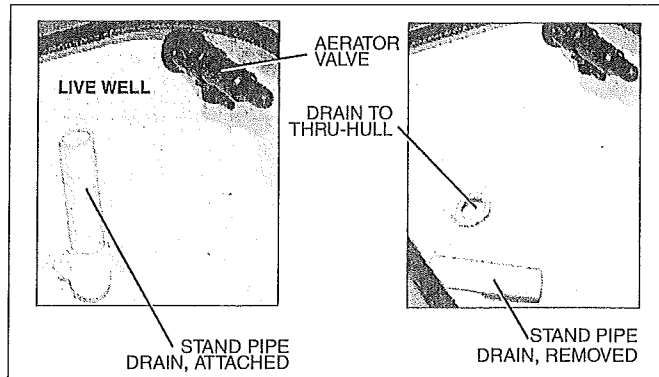

The live well pump should be shut off while underway at planing speeds.

Bilge Pump

This boat is equipped with one bilge pump, located at the lowest point of the bilge. The flow rate of the pump is 31.6 L (8.3 gal) per minute.

The electric bilge pump supplied with your boat is an impeller-type pump. It is controlled by a switch on the dash panel, which should be activated whenever water begins to accumulate in the bilge. Some models will also have an automatic bilge pump switch (“autofloat switch”) mounted next to the pump. This is a float-type switch that will activate the bilge pump automatically whenever the bilge water accumulates above a pre-set level. It is wired directly to the battery so it will normally function even when the boat is completely shut down and unattended, such as when the boat is moored at a marina.

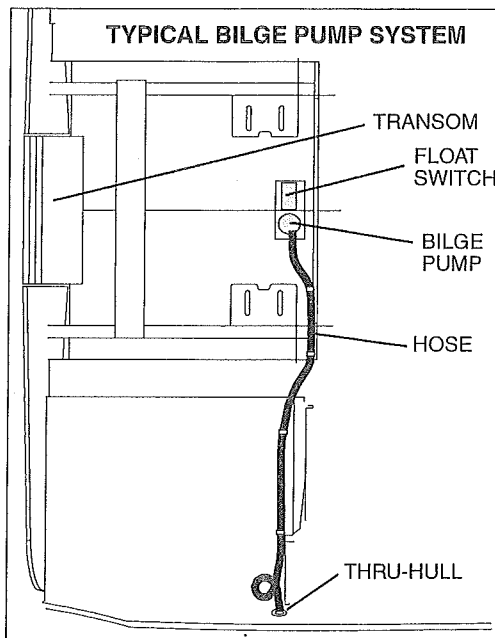

Operation of the bilge pump should be checked often. To check the bilge pump, activate the dash-mounted switch and verify that water in the bilge is pumped overboard. If bilge water is present and the pump motor is running but not pumping, inspect the discharge hose for a kink or collapsed area. If no problems are found, check the bilge pump housing for clogging debris:

To remove the power cartridge:

1. Lift the tab while rotating the fins counter clockwise and lift out the power cartridge (Fig. 1).
2. Clear the housing of debris.

To reinstall the power cartridge:

1. Make sure the “O” ring is properly located and coat the “O” ring with a light film of vegetable oil or mineral oil (Fig. 2).

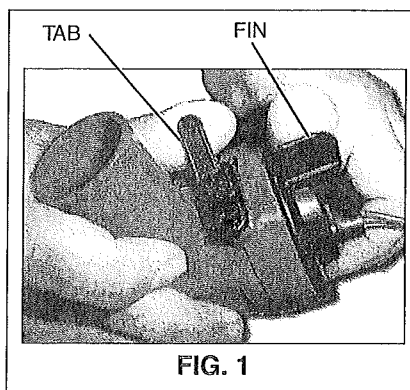

- Align the two cams on either side of the power cartridge with the two slots on the outer housing. Press the power cartridge into the housing and twist clockwise. Ensure proper reinstallation by attempting to twist the fins counter clockwise without lifting the tab. The cartridge should stay in place.

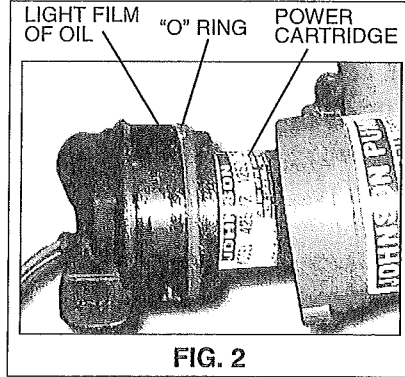

FIG. 2

If applicable, the autofloat switch should also be checked often for proper operation. Lift the float by turning the plastic insert, where the wires enter the housing, 1/4 turn counter clockwise (Fig. 3).

As the float is lifted, the bilge pump should turn on. If lifting the float does not turn the pump on, check the inline fuse. If the fuse is good but the switch does not work, it may indicate a bad switch or possibly a low battery.

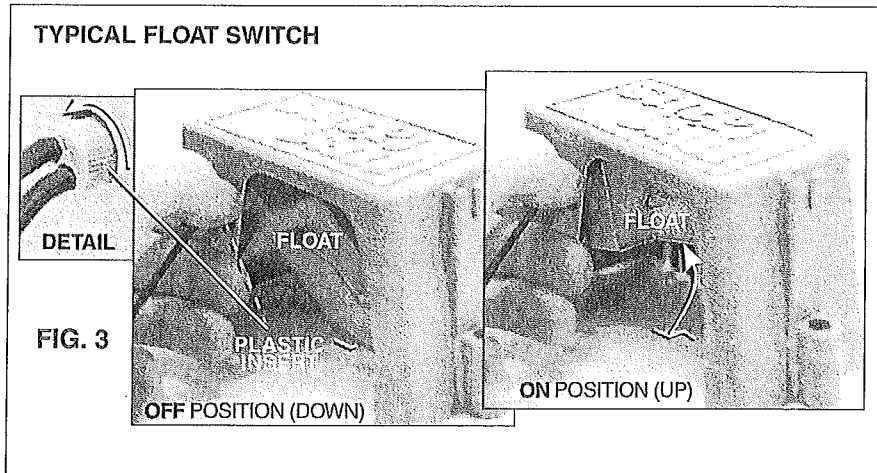

FIG. 3



Discharge of oil, oil waste or fuel into navigable waters is prohibited by law. Violators are subject to legal action by the local authorities.

Fresh Water System

Fresh water systems are available on some models. These pressure-type (demand) systems operate when the water pump switch (located near the sink in the cuddy cabin) is in the ON position. Turn the pump switch OFF when the boat is not in use and when the water tank is empty.

Stored water can become stagnant and distasteful. Pump the water tank dry before leaving your boat unattended for long periods of time. Occasionally you may want to disinfect your water system. Ask your selling dealer about available treatments and procedures.

Your boat may be equipped with a transom shower. Please read and follow the manufacturer's operating instructions supplied in your owner's packet.

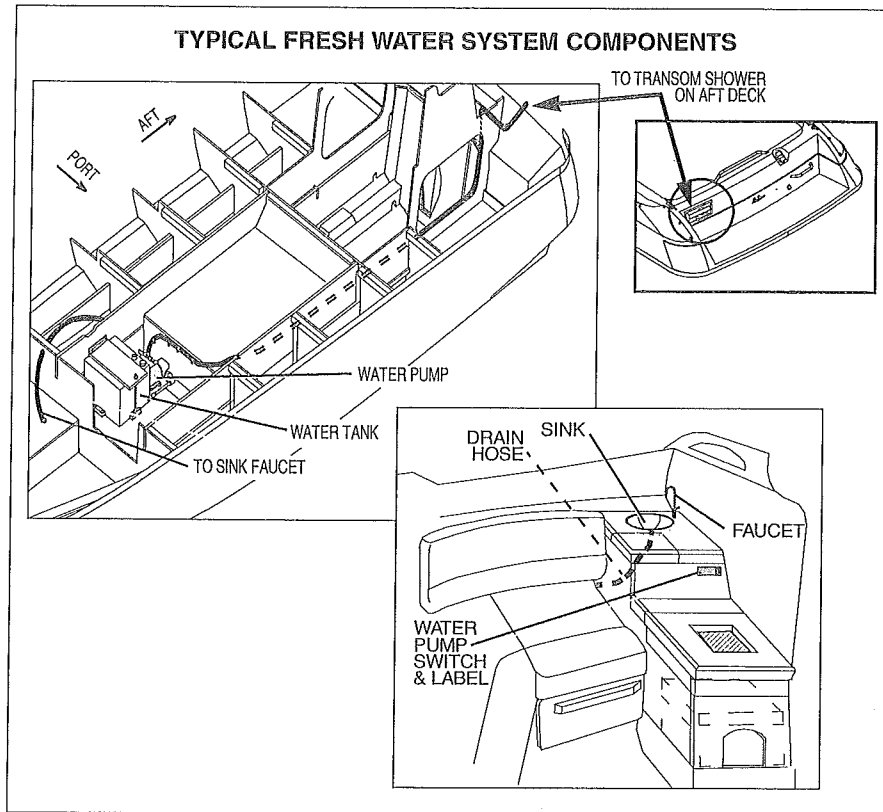

Marine Head With Pump Out

If your boat features a marine head and pump out system, carefully read the manufacturer's owner's manual supplied in your owner's packet.

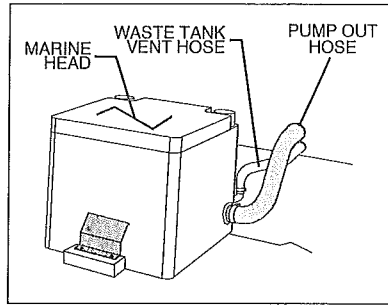
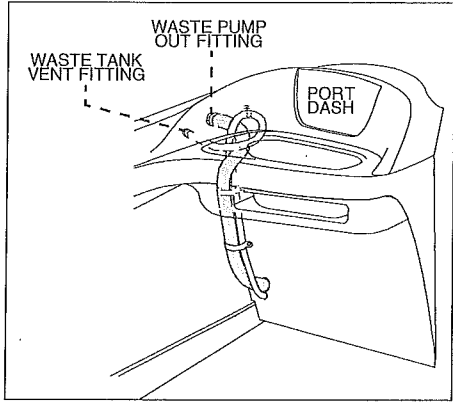

Portable Toilet

Your boat may feature a portable toilet. We recommend that you carefully read and follow the manufacturer's operating instructions supplied in your owner's packet before using your portable toilet.

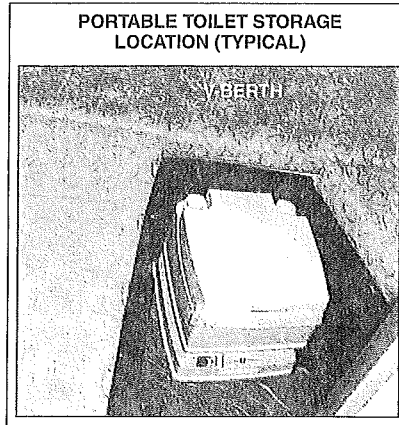

Alcohol Stove



Reduce the possibility of fire by removing all combustible materials away from the stove before/during use

If your boat features a single burner alcohol stove, carefully read and follow the manufacturer's operating instructions supplied in your owner's packet before using your stove for the first time.

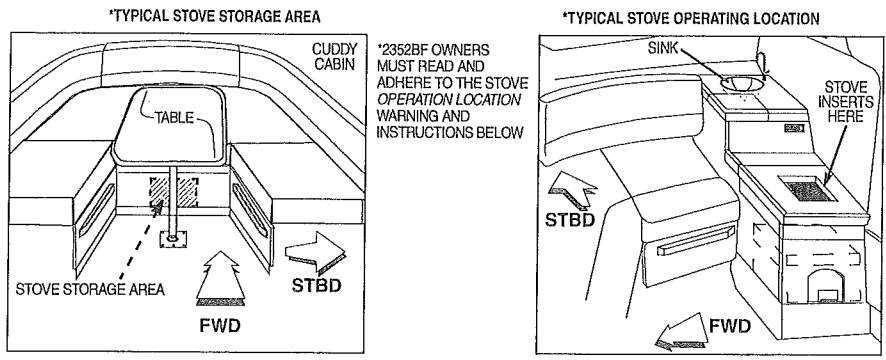

2352BF ONLY - FIRE HAZARD. The portable stove must be placed in the designated operating location when in use (see photos below).

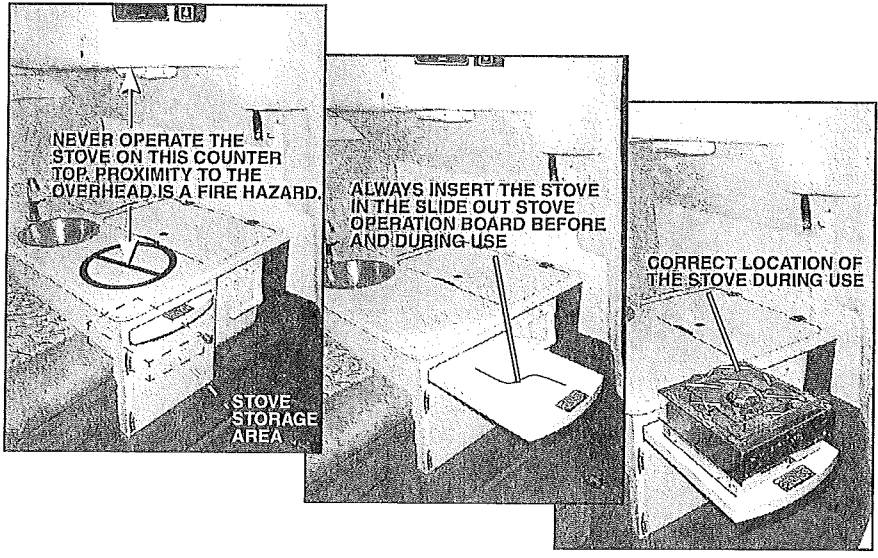

Aft Jump Seat Conversion

Your boat may feature convertible aft jump seats. The following is the typical procedure for converting jump seats into a sunlounge. This procedure may differ slightly for your model:

1. Remove the port jump seat (FIG. 1). Rotate it 90° clockwise and slide the lounge support insert into the *starboard* side opening of the motor box pad (FIG 2).

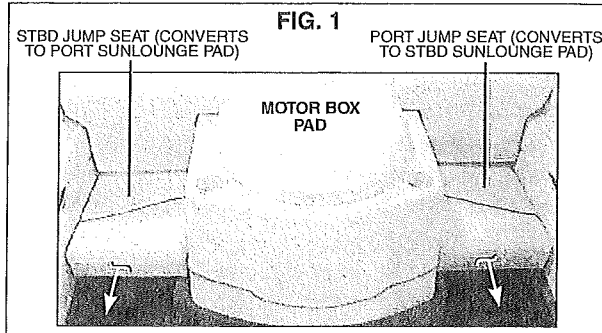

2. Remove the starboard (stbd) jump seat (FIG. 1). Rotate it 90° counter-clockwise and slide the lounge support insert into the *port* side opening of the motor box pad (FIG 3).

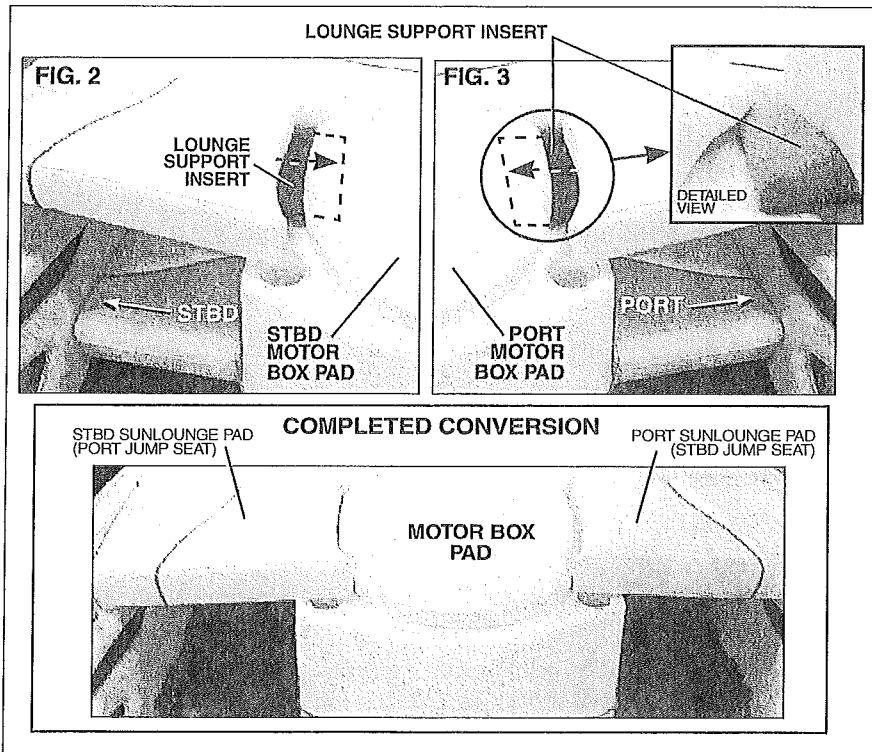

Sleeper Seat Adjustment

Your boat may be equipped with adjustable sleeper seats. These seats can be adjusted fore and aft in the upright position. The seat bottoms of these models also adjust into backrests while the seat is in the lounge position.

Fore-aft positions:

1. To slide the seat forward or backward, lift up on the front edge of the seat bottom (A).
2. Move the seat forward until the locking mechanism engages in one of the three different positions
3. Lift the aft seat at point (B) and slide the aft seat towards the forward seat.

Lounge positions:

1. To put the seat into the lounge position, lift up on the front edge of the seat (A) and pull the seat all the way forward. Lift the aft seat at (B) and pull the aft seat away from the forward seat until the seat is laid out flat.
2. Lift up on the forward or aft seat bottom at point (C) until the seat bottom drops into the locked position.
3. To lower the seat bottom, lift the seat at points (C) and (D) at the same time. Drop the seat bottom flat while holding the seat up at point (D).
4. To return the seat to the operating position, lift the seat back at point (E) and push the seat bottom toward the center of the seat until it locks into place.

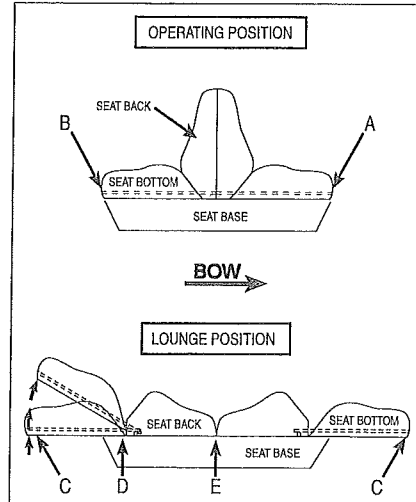

Pedestal Seats

Your boat may feature pedestal seating. Fore and aft pedestal seats should be removed and stowed in a safe and secure area while underway or when trailering your boat.



PERSONAL INJURY HAZARD!

NEVER occupy the fore or aft pedestal seats while your boat is underway.

Sitting on the fore or aft pedestals while underway is especially hazardous and will cause personal injury or death.

Canvas Top Installation

1. Attach eye ends of main bow (See point A below) to deck hinges on the boat and remove boot if necessary.
2. Unfold canvas top and stretch the front edge of the top across the windshield frame and snap to frame (B). Use care to center the canvas on the windshield. Close the front zipper (C).
3. Pull back on the top (D), making sure the canvas lies evenly from side to side and hook the hold down straps (E) to the deck loops located near the rear of the windshield side wing. If the canvas top does not have a smooth, taut look, adjust by holding the rear of the top and tightening the straps by pulling on the strap buckle. When properly adjusted, both sides of the top will be even.
4. Align the secondary bow (F) with the center seam of the canvas by loosening or tightening the top straps (G). No adjustments to the secondary bow jaw slide (H) should need to be made as they are preset during manufacturing. Before attempting to adjust the jawslide position, obtain the correct measurements from your selling dealer.
5. If additional canvas (i.e. side curtains, slant back cover, or camper cover) is to be installed, it should be snapped to the top canvas before final adjustment. The top can then be adjusted as in steps 3 and 4 to bring the lower row of snaps on the canvas in line with the row on the boat. Like the top, the additional canvas pieces are in proper adjustment when they are smooth and taut.

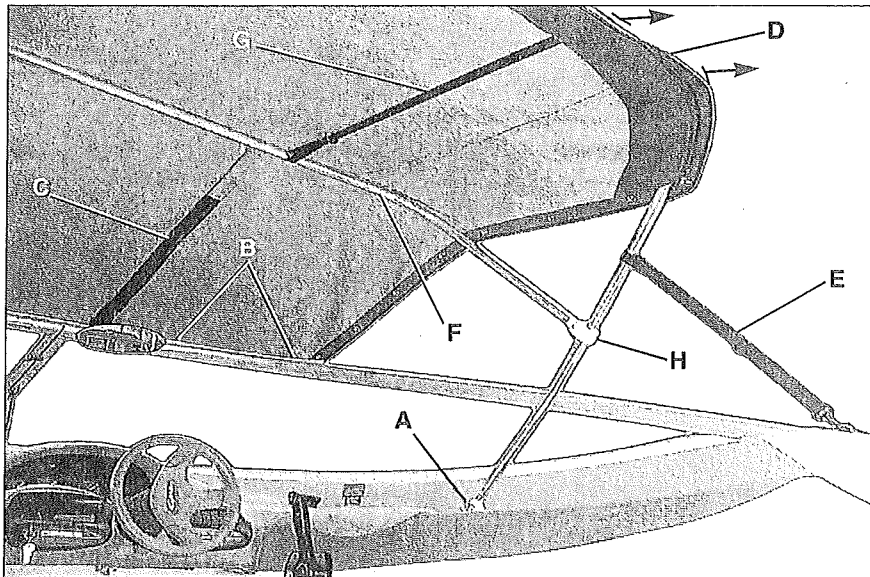

Canvas Stowage



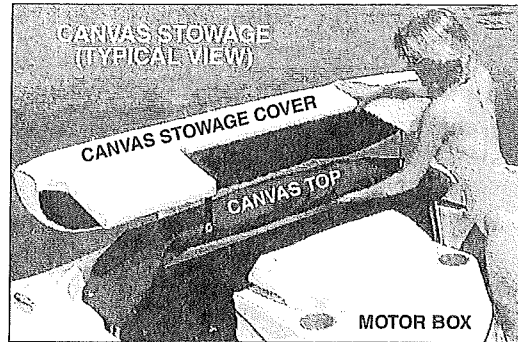

















Your boat may feature ventilated stowage space for the canvas top under either the canvas stowage cover or the aft sunlounge pad.



























































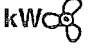

CHAPTER 4: ISO SYMBOLS

These ISO symbols may be used throughout your boat, the Owner's Manual and this Owner's Manual Supplement to identify and describe the various systems and components.

Definitions

<i>Symbol</i>	<i>Description</i>	<i>Symbol</i>	<i>Description</i>
	Air Cooled Charge Air Cooler		Air, Intake (For Combustion)
	Air, General		Anchor
	Blower		Compass
	Counter Clockwise Rotation		Crankshaft Power
	Disengage		Elapsed Time
	Electric Generator		Electrical Preheat for Diesel Engine
	Engage		Engine
	Engine Air Intake		Engine Inlet Air Filter
	Engine Inlet Air Pressure		Engine Inlet Air Temperature
	Engine Exhaust Gas Pressure		Engine Exhaust Gas

<i>Symbol</i>	<i>Description</i>	<i>Symbol</i>	<i>Description</i>
	Engine Exhaust Gas Temperature		Engine Oil
	Engine Oil Temperature		Engine Oil Pressure
	Engine Oil Filter		Engine Oil Level
	Engine Coolant		Engine Water Jacket Drain
	Engine Start		Engine Rotation Speed, R/MIN
	Exhaust Gas		Filter
	Fresh Water		Fresh Water Tank
	Fresh Water Cooled Charged Air		Fuel General
	Fuel Level		Fuel Filter
	Fuel Shut Off		Fuel, Diesel
	Fuel, Unleaded		Fuel, Liquid Propane Gas
	Fuel Tank, Diesel		Fuel Tank, LPG
	Fuel Tank, Unleaded		Heat Exchanger
	Holding Tank		Horn

<i>Symbol</i>	<i>Description</i>	<i>Symbol</i>	<i>Description</i>
	Hydraulic Oil		Hydraulic Oil Filter
	Hydraulic Oil Level		Hydraulic Oil Pressure
	Hydraulic Oil Temperature		Hydraulic System
	Hydraulic System Malfunction		Interior Light
	Lift Point		Light
	Lubricating Oil		Malfunction
	No Open Flame		Oil Tank
	Outboard Drive		Outboard Drive Tilt
	Pressure		Propeller
	Propshaft Power		Propulsion System Trim
	Propulsion System Trim, Bow Down		Propulsion System Trim, Bow Up
	Pump		Read Owner's Manual
	Seawater		Shift Only Fwd-N-Rev
	Sling Location		Tank
	Throttle/Shift		Transmission

<i>Symbol</i>	<i>Description</i>	<i>Symbol</i>	<i>Description</i>
	Transmission Oil		Transmission Oil Filter
	Transmission Oil Level		Transmission Oil Malfunction
	Transmission Oil Pressure		Transmission Oil Temperature
	Trim Tab Operation		Trim Tab Operation, Bow Down
	Trim Tab Operation, Bow Up		Volume Empty
	Volume Full		Volume Half Full
	Warning		Warning Electrical Hazard
	Warning Fire Risk		Warning Hot
	Waste Water, Sewage		Water Flushing Connector
	Windshield Washer Tank		Windshield Wiper & Washer

LIMITED WARRANTY

Bayliner warrants to the original purchasers of its 1999/2000 model boats, purchased from an authorized dealer, operated under normal, noncommercial use that the selling dealer will: (A) Repair any structural hull defect which occurs within five (5) years of the date of delivery; and (B) Repair or replace any parts found to be defective in factory material or workmanship within one (1) year of the date of delivery.

What Is Not Covered

This limited warranty does not apply to:

1. Engines, drive trains, controls, props, batteries, or other equipment or accessories carrying their own individual warranties;
2. Engines, parts or accessories not installed by Bayliner;
3. Plexiglass windscreen breakage; rainwater leakage on runabout models; rainwater leakage through convertible tops; minor gelcoat discoloration, cracks or crazing or air voids;
4. Hull blisters that form below the waterline;
5. Normal deterioration, i.e. wear, tear, or corrosion of hardware, vinyl, tops, vinyl and fabric upholstery, plastic, metal, wood, or trim tape;
6. Any Bayliner boat which has been overpowered according to the maximum horsepower specifications on the capacity plate provided on each Bayliner outboard boat;
7. Any Bayliner boat used for commercial purposes;
8. Any defect caused by failure of the customer to provide reasonable care and maintenance.

Other Limitations

THERE ARE NO OTHER EXPRESS WARRANTIES ON THIS BOAT. TO THE EXTENT ALLOWED BY LAW:

1. ANY IMPLIED WARRANTY OF MERCHANTABILITY OR FITNESS FOR A PARTICULAR PURPOSE IS LIMITED TO THE DURATION OF ONE YEAR.
2. Neither Bayliner nor the selling dealer shall have any responsibility for loss of use of the boat, loss of time, inconvenience, commercial loss or consequential damages.
3. Some jurisdictions do not allow limitations on how long any implied warranty lasts, so the above limitation may not apply to you. Some jurisdictions do not allow the exclusion or limitation of incidental or consequential damages, so the above limitation or exclusion may not apply to you. This limited warranty gives you specific legal rights, and you may also have other rights which vary from state to state.

Your Obligation

In order to comply with regulations, it is essential that your limited warranty registration card be submitted within 30 days of delivery of your boat. Return of the limited warranty registration card is a condition precedent to limited warranty coverage. Before any warranty work is performed, we require that you contact your dealer to request warranty assistance.

YOU MUST GIVE US WRITTEN NOTICE OF YOUR WARRANTY CLAIM PRIOR TO THE EXPIRATION OF YOUR LIMITED WARRANTY AND ALLOW US AN OPPORTUNITY TO RESOLVE THE MATTER.

We require that you return your boat, at your expense, to your selling dealer or, if necessary, to the Bayliner factory. You will be responsible for all transportation, haulouts and other expenses incurred in returning the boat for warranty service.

Bayliner Marine Corporation
PO Box 9029
Everett, WA 98206

Phone: 360-435-8957
FAX: 360-403-4235

