

**OWNER'S MANUAL
SUPPLEMENT**

**4788 PILOTHOUSE
MOTORYACHT**



BAYLINER

BAYLINER®

Congratulations and welcome aboard your new Bayliner Motoryacht!

Thank you for choosing our product. Bayliner is committed to the goal of building the highest quality products in the marine industry and to providing the finest after-the-sale support in the world.

To keep our respected status as the number one boat builder in the world, Bayliner has instituted an ongoing **Total Customer Satisfaction Program**.

The guiding principles of this program are:

- ✓ *Design, build and support the finest marine products in the world, in every market we serve.*
- ✓ *Be personally and individually responsible for the customer's total satisfaction.*
- ✓ *Remember that every customer has a choice, and we want them to choose Bayliner!*

Welcome to the Bayliner family. We are looking forward to serving your boating needs, now and in the future!

CONTENTS

CHAPTER 1: ABOUT THIS MANUAL

- 1 Dealer Service
- 1 Boating Experience
- 1 Engine/Accessories Guidelines
- 1 Safety Standards
- 1 Qualified Maintenance
- 2 Structural Limitations
- 2 Hazard Warning Symbols
- 2 Special Care For Moored Boats

CHAPTER 2: PRODUCT DESCRIPTION

- 3 Dimensions and Capacities
- 3 Layout View
- 3 Lifting Sling Positions
- 4 Hull Exterior Hardware

CHAPTER 3: COMPONENTS / SYSTEMS

- 5 VHF Radio
- 5 Radar
- 5 Autopilot
- 5 Depth Finder
- 5 Compass
- 5 Trim Tabs
- 6 Anchor Windlass
- 6 Spotlight
- 6 Windshield Wipers
- 6 Davit
- 7 Electrical System
- 8 12-Volt DC System
 - 8 *Fuses and Circuit Breakers*
 - 8 *Battery Switches*
 - 8 *Batteries*
 - 8 *Engine Alternators*
 - 8 *Battery Charger*
- 8 110-Volt AC System
 - 9 *Shore Power*
 - 10 *Generator Power*
- 11 Fuel System
 - 11 *Fuel Fills and Vents*
 - 11 *Fuel Management Board*
 - 11 *Fuel Transfer Pump (Diesel Only)*
 - 12 *Fuel Quality*
 - 12 *Fuel System Diagrams*

- 13 Engine Room Ventilation System
- 13 Water Pickup Systems
- 13 Exhaust Systems
- 14 Shaft-Transmission Alignment
 - 14 *Checking Alignment*
- 14 Shaft Log Stuffing Box Packing
- 15 Steering System
 - 15 *Rudder Stuffing Gland*
- 15 Fresh Water System
 - 16 *Water Heater*
 - 16 *Drain System*
- 16 Washdown Systems
- 17 Bilge Pump System
 - 17 *Bilge Pump Maintenance*
- 18 Marine Head System
- 19 Air Conditioning/Heating (Optional)
- 19 110-Volt AC/12-Volt DC Refrigerator
- 19 Ice Maker
- 20 Blender
- 20 Range/Oven
- 20 Microwave Oven
- 20 Trash Compactor
- 20 Washer/Dryer (Optional)
- 20 Vacuum System
- 20 Audio/Video Equipment

CHAPTER 4: WIRING DIAGRAMS

- 21 Standard Dual Dockside
- 22 Accessory DC Circuits
- 23 Gas Engine Electrical System
- 24 Diesel Engine Electrical System

EXPRESS LIMITED WARRANTY

CHAPTER 1: ABOUT THIS MANUAL

This Owner's Manual Supplement was prepared to provide specific information about your yacht. Please study this supplement and the Owner's Manual carefully, paying particular attention to the **LIMITED WARRANTY** section. Keep this supplement in a secure place and hand it over to the new owner when you sell the boat.

Dealer Service

Make certain that you receive a full explanation of all systems from the selling dealer before taking delivery of your yacht. Your selling dealer is your key to service. If you experience any problems with your new yacht, immediately contact the selling dealer. If for any reason your selling dealer is unable to help, you can call us direct on our customer service hotline: 360-435-8957 or send us a FAX: 360-403-4235

Boating Experience

If this is your first boat or if you are changing to a type of boat you are not familiar with, for your own comfort and safety, please ensure that you obtain handling and operating experience before assuming command of the yacht.

We strongly recommend that you take one of the boating safety classes offered by the U.S. Power Squadrons (<http://www.usps.org/>) or the U.S. Coast Guard Auxiliary (<http://207.201.180.170/>). For more course information, including dates and locations of upcoming classes, visit their web sites or call their local offices.

Outside the U.S., your selling dealer, national sailing federation or local yacht club can advise you of local sea schools or competent instructors.

 WARNING
<p>CONTROL HAZARD - A qualified operator must be in control of the yacht at all times. DO NOT operate your yacht while under the influence of alcohol or drugs.</p>



Engine/Accessories Guidelines

Your yacht's engines and accessories were selected to provide optimum performance and service. Installing different engines or other accessories may cause unwanted handling characteristics. Should you choose to install different engines or to add accessories that will affect the boat's running trim, have an experienced marine technician perform a safety inspection and a handling test before operating your yacht by yourself again.

Safety Standards

Your yacht's mechanical and electrical systems were designed to meet safety standards in effect at the time it was built. Some of these standards were mandated by law. All of them were designed to insure your safety, and the safety of other people, vessels and property.

Please read the Owner's Manual for important safety standards and hazard information.

 DANGER
 <p>PERSONAL SAFETY HAZARD - DO NOT allow anyone to ride on parts of the yacht not designated for such use. Sitting on seat backs, lounging on the forward deck, bow riding, gunwale riding or occupying transom platform while underway is especially hazardous and will cause personal injury or death.</p>

Qualified Maintenance

 WARNING
<p>To maintain the integrity and safety of your yacht, only qualified personnel should perform maintenance on, or in any way modify: The steering system, propulsion system, engine control system, fuel system, environmental control system, or electrical system.</p>

Failure to maintain these systems (listed in the warning above) as designed could violate the laws in your jurisdiction and could expose you and other people to the danger of bodily injury or accidental death. We recommend that you follow the instructions provided in this supplement, the Owner's Manual, the engine owner's manual and the accessory instruction sheets included with your boat.

Structural Limitations

The command bridge, transom platform and bow platform are designed to be lightweight for proper boat balance. The load limit for these platforms and the command bridge is 30 pounds per square foot, evenly distributed.

Hazard Warning Symbols

The hazard warning symbols shown below are used throughout this supplement to call attention to potentially dangerous situations which could lead to either personal injury or product damage. We urge you to read these warnings carefully and follow all safety recommendations.

	DANGER
This symbol alerts you to immediate hazards which <u>WILL</u> cause severe personal injury or death if the warning is ignored.	

	WARNING
This symbol alerts you to hazards or unsafe practices which <u>COULD</u> result in severe personal injury or death if the warning is ignored.	

	CAUTION
This symbol alerts you to hazards or unsafe practices which <u>COULD</u> result in minor personal injury or cause product or property damage if the warning is ignored.	

NOTICE	
This symbol calls attention to installation, operation or maintenance information, which is important to proper operation but is not hazard-related.	

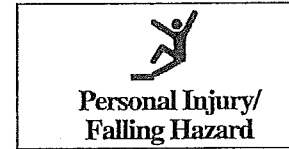

Special Care For Moored Boats

If moored in saltwater or fresh water, your boat will collect marine growth on its hull bottom. This will detract from the boat's beauty, greatly affect its performance and may damage the gelcoat. There are two methods of slowing marine growth:

- Periodically haul the boat out of the water and scrub the hull bottom with a bristle brush and a solution of soap and water.
- The hull below the waterline was painted with anti-fouling paint by the factory. Occasionally you will need to re-paint it with a good grade of anti-fouling paint.

NOTICE	
<ul style="list-style-type: none"> • To help seal the hull bottom and reduce the possibility of gelcoat blistering on moored boats, we recommend the application of an epoxy barrier coating, such as INTERLUX, <i>Interprotect 2000E/2001E</i>. The barrier coating should be covered with several coats of anti-fouling paint. • Many states regulate the chemical content of bottom paints in order to meet environmental standards. Check with your local dealer about recommended bottom paints, and about the laws in effect in your area. 	

CHAPTER 2: PRODUCT DESCRIPTION

Dimensions and Capacities

Overall Length	Bridge Clearance	Beam	Draft	Fuel Tank Capacity (gal)	Water Tank Capacity (gal)	Holding Tank Capacity (gal)
47' 4"	18' 2"	14' 11"	3' 4"	444	200	48

Layout View

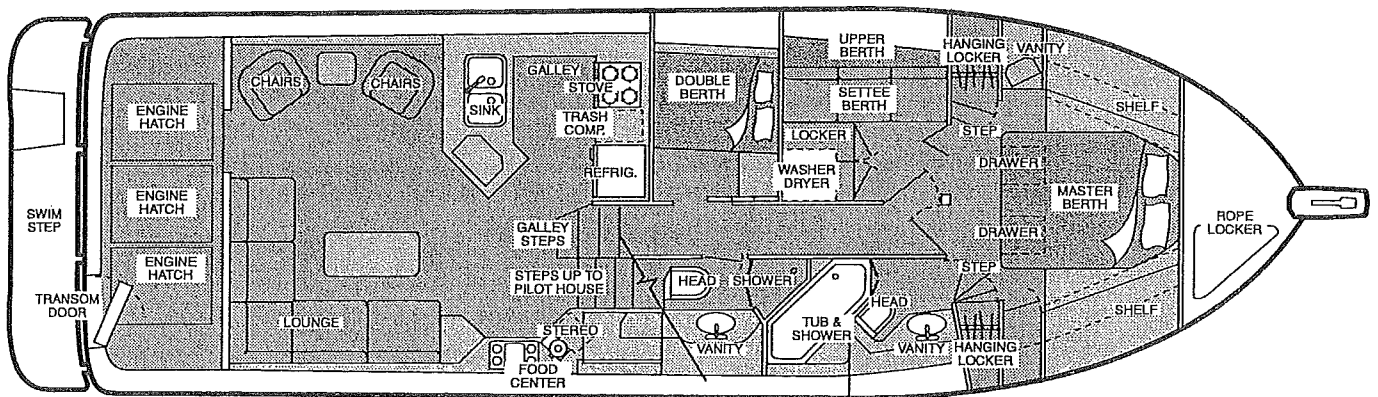

Lifting Sling Positions

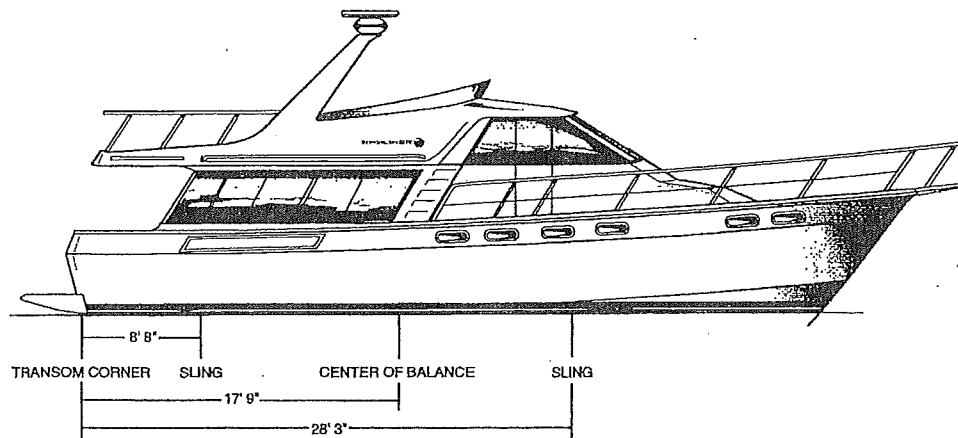

Hull Exterior Hardware

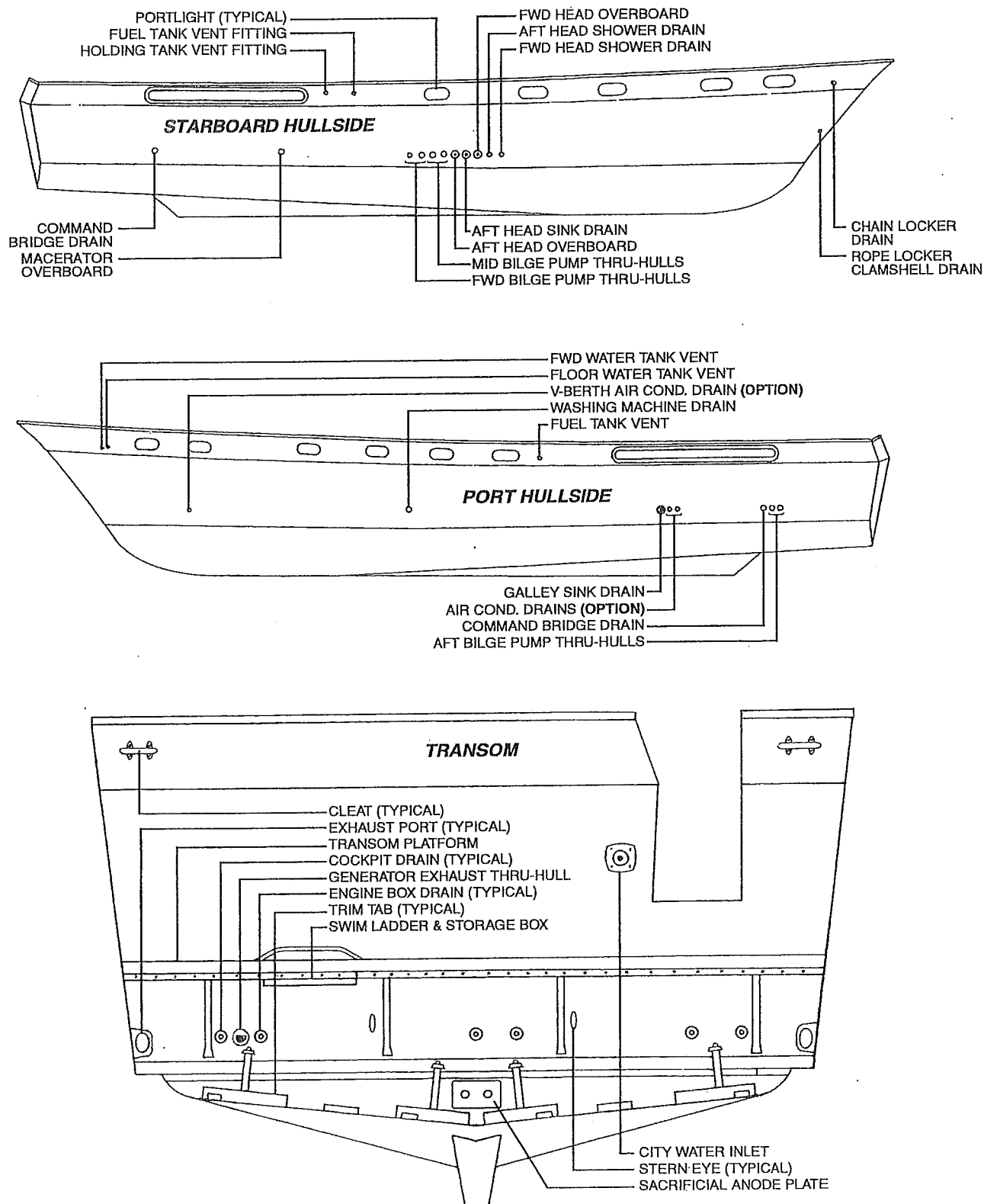

CHAPTER 3: COMPONENTS / SYSTEMS

VHF Radio

The VHF radio has a separate brochure, in your yacht's owner's packet, that explains its operating features. We strongly suggest that you read the operating instructions before using the radio.

Radar

Your Motoryacht is equipped with a marine radar system that will give you complete and accurate 360° radar picture of other vessels, buoys, and landfall surrounding your vessel. To turn this system on, the RADAR switch on the DC breaker panel must be activated. It is recommended that you become familiar with the operating procedures described in the literature supplied with your vessel before operating this system.

Autopilot

The autopilot will aid you in maintaining the chosen heading of your Motoryacht automatically. Before activating the AUTOPILOT switch on the DC breaker panel, refer to the literature supplied with your vessel. It will explain the safe operation methods for this system.

Depth Finder

The depth finder will provide you with measurements of water depth beneath the boat. We suggest that you read the manufacturer's operating instructions included in your yacht's owner's packet before using the unit.

⚠ WARNING

DO NOT use the depth finder as a navigational aid to prevent collision, grounding, boat damage or personal injury. When the boat is moving, submerged objects will not be seen until they are already under the boat. Bottom depths may change too quickly to allow time for the boat operator to react. If you suspect shallow water or submerged objects, operate the boat at very slow speeds.

Compass

Carefully read and follow the compass manufacturer's calibration and operating instructions provided in your yacht's owner's packet.

Trim Tabs

Trim tabs control the longitudinal and lateral trim of your boat at cruising speeds. Two rocker switches identified by the words "BOW DOWN" are located at each helm station.

Once the best bow cruising trim is reached, use the port or starboard trim switches, one at a time, to correct for unequal lateral loading. **DO NOT** use trim tabs to compensate for excessive unequal weight distribution.

Trim tab adjustment should be performed by several short touches to the switch rather than one long one. After each short touch allow about five seconds for the hull to react.

The trim tab hydraulic fluid reservoir is located in the engine compartment. The fluid level should be checked periodically (at least once a year) and refilled as necessary.

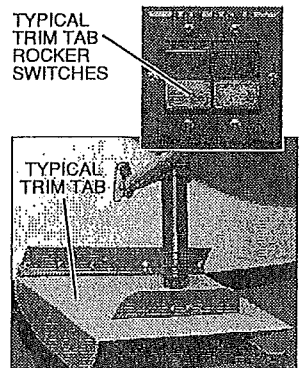

⚠ WARNING

Improper use of trim tabs may cause loss of control. DO NOT use trim tabs in a following sea as they may cause broaching or other unsafe handling characteristics. DO NOT let anyone unfamiliar with trim tabs to operate them.

Anchor Windlass

Please read the manufacturer's instructions in your yacht's owner's packet. To haul the anchor, use engine power (*not* the windlass) to move the boat to, and directly over, the anchor. Activate the windlass to disengage the anchor from the bottom by pulling it straight up. **DO NOT** pull the boat to the anchor using the windlass or continue to operate the windlass if it stalls or is overloaded.

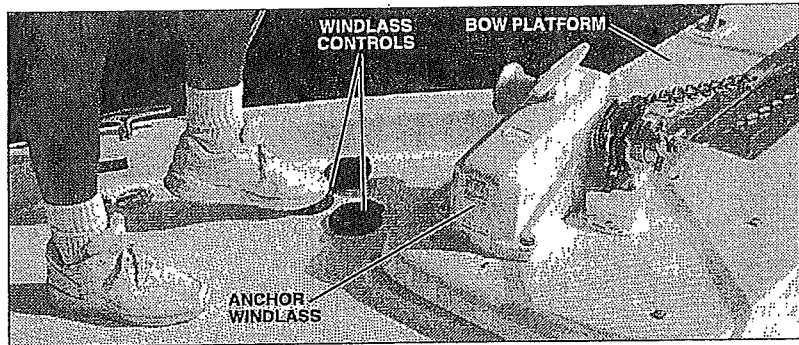

Spotlight

The spotlight has a separate brochure explaining its features. The spotlight can be controlled from either helm station, as long as the dual switch in the pilot house is activated for the station at which you desire control. The spotlight is located on the bow platform.

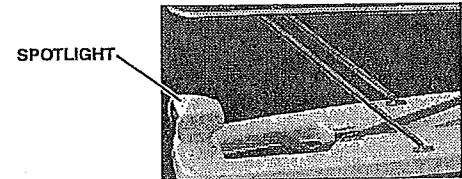

Windshield Wipers

The windshield wiper fluid bottle can be accessed through the port pilot house jump seat.

Davit

See the literature package for complete operating instructions for the davit (winch). The davit control receptacle is located on the bulkhead just forward of the davit.

Inspect the cable often for wear and replace it when frayed. The cable should be kept tight and even on the spool, and under tension when operating the winch.

The cables should be disconnected from the bulkhead-mounted quick-disconnect fittings when the davit is not in use. After removing cables, the load should be secured.

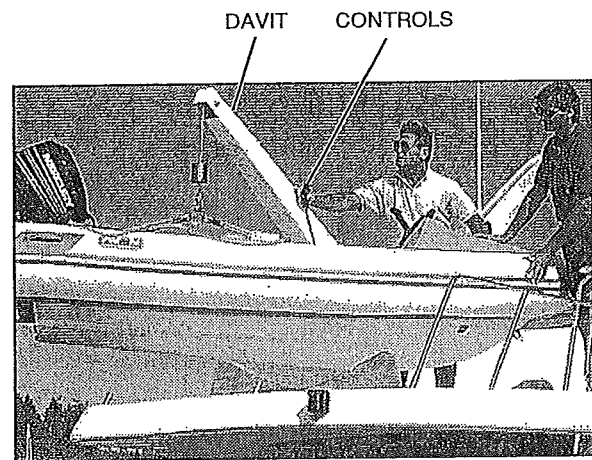
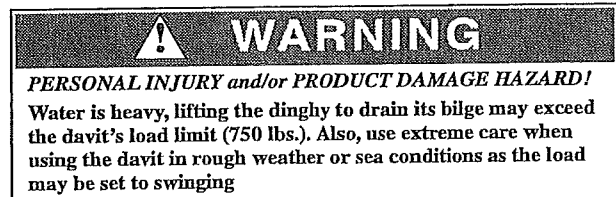
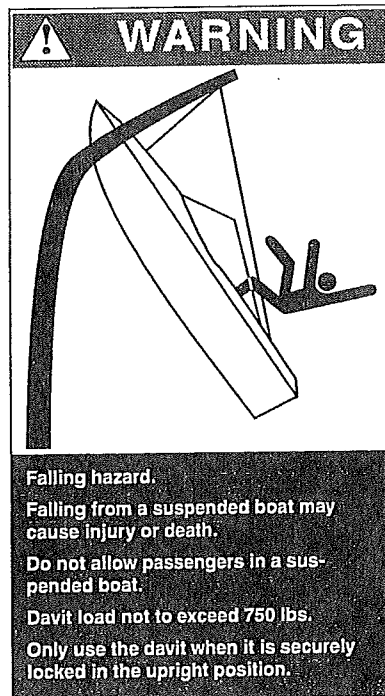

Electrical System

We strongly recommend that you read and understand this section and the Electrical Section of the Owner's Manual. Wiring diagrams are provided in CHAPTER 4 for use in troubleshooting electrical problems.

⚠ DANGER



EXTREME FIRE/EXPLOSION HAZARD!

- To minimize the risks of fire and explosion, *NEVER* install knife switches or other arcing devices in the fuel compartments.
- *NEVER* substitute automotive parts for marine parts. Electrical, ignition and fuel system parts were designed and manufactured to comply with rules and regulations that minimize risks of fire and explosion.
- *DO NOT* modify the electrical systems or relevant drawings.
- Only qualified personnel should install batteries and/or perform electrical system maintenance.
- Insure that all battery switches are in the OFF position before performing any work in the engine spaces.

⚠ WARNING

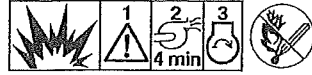

FIRE/EXPLOSION HAZARD!

- Fuel fumes are heavier than air and will collect in the bilge areas where they can be accidentally ignited. Visually and by smell (sniff test), check the engine and fuel compartments for fumes or accumulation of fuel. Operate the bilge blowers for at least four minutes prior to engine starting, electrical system maintenance or activation of electrical devices.
- Minimize the danger of fire and explosion by not exposing batteries to open flame or sparks. It is also important that no one smoke anywhere near the batteries.

⚠ CAUTION



SHOCK/ELECTRICAL SYSTEM DAMAGE HAZARD!

- Never disconnect the battery cables while the engine is running as this can cause damage to your boat's electrical system components.
- The battery charging systems (alternators and battery charger) on your yacht are designed to charge conventional lead-acid batteries. Before installing gel-cell or other new technology batteries, consult with the battery manufacturer about charging system requirements.

NOTICE

- Electrical connections are prone to corrosion. To reduce corrosion caused electrical problems, keep all electrical connections clean and protect them with a spray-on protectant such as Corrosion Guard®.
- **VOLTAGES** - All boats use either 110-volt AC/60 Hertz, 240-volt AC/60 Hertz or 220-volt AC/50 Hertz single phase systems, and 12-volt DC or 24-volt DC. Electrical distribution panels are labeled with voltage and frequency of AC and DC.

12-Volt DC System

Fuses and Circuit Breakers

The master circuit breakers for accessory power, windlass power and davit power are located next to the battery switches in the aft cabinet on the port side of the salon. Individual component circuit breakers are located on the DC distribution panel in the AC/DC cabinet on the starboard side of the pilot house.

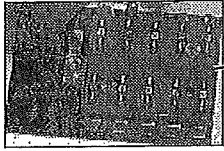

ACCESSORY FUSE
BLOCK (TYPICAL)

An accessory fuse block for electronics, such as the VHF radio, is located at each helm station. Some equipment, such as depth finders and shower pumps may have secondary fuse protection at the unit.

Battery Switches

Rotary switches, located in the aft cabinet on the port side of the salon, are provided for the batteries. A separate switch is provided for each battery. In addition, a parallel switch is provided at each helm to enable you to start the engines using all engine batteries in the event that engine battery power is low.

Batteries

The batteries supply electricity for lights, engine and generator starting, as well as power to turn on accessories. *Periodically remove the battery caps and check the electrolyte level.* If the zinc plates are exposed, add distilled water until they are covered. Corroded battery terminals can be cleaned with baking soda and water. After cleaning the terminals, coat them with a light film of grease. Be sure all battery connections are tight.

Battery condition can be checked on the "Electrical System Monitor" located on the DC distribution panel. The condition of the accessory battery can be read on the starboard engine voltmeter when the accessory battery switch is in the ON position. The starboard voltmeter will register the accessory battery state even when the engines are shut down and the ignition switches are turned off.

Engine Alternators

The engine alternators will maintain proper charge levels in the engine and accessory batteries (some situations may require running engines at 1200 RPM to initiate charging).

Battery Charger

In addition to the engine alternators, your yacht is equipped with a battery charger. We recommend that you thoroughly read and understand the battery charger manual, provided in your yacht's owner's packet, before using the charger. The battery charger is located in the engine compartment on the port side. The circuit breaker for the battery charger (located on the main AC power panel) must be ON for charging to occur.



CAUTION

The battery charging systems (alternator and battery charger) installed are designed to charge conventional lead-acid batteries. Before installing gel-cell or other new technology batteries, consult with the battery manufacturer about charging systems requirements.

110-Volt AC System

The AC system can be energized by shore power or the onboard generator. Master circuit breakers, located on the AC panel, provide power source selection. This system is designed so that ship's power and shore power sources *cannot* supply power simultaneously.



CAUTION

Whether using shore power or the onboard generator, the simultaneous use of several AC components can result in an overloaded circuit. It may be necessary to turn off one or more accessories in order to use another accessory.



 **CAUTION**

WATER HEATER DAMAGE HAZARD! DO NOT energize the AC water heater electrical circuit until the heater is *completely* filled with water. Even momentary operation in a dry tank will damage the heating elements. Warranty replacements *will not* be made on elements or tank damaged in this manner. The tank is full if water flows from the tap when the hot water is turned on in the galley.

Shore Power

Shore power receptacles are located outside the pilot house on the starboard side. Shore power receptacles are rated either 30 or 50 amps with appropriate power cords furnished. Since not every shore installation has 30 amp service, we recommend that 15 and 20 amp adapters be purchased. However, whenever 15 or 20 amp adapters are used, there will be a corresponding drop in supplied power from the dockside system.

 **DANGER**

   **FIRE/EXPLOSION/SHOCK HAZARD!**

- To minimize shock and fire hazard, **DO NOT** modify electrical systems or relevant drawings.
- **DO NOT** alter shore power connectors and use only compatible connectors.
- Only qualified personnel should install batteries and/or perform electrical system maintenance.

 **CAUTION**

 **SHOCK/ELECTRICAL SYSTEM DAMAGE HAZARD!**

- Never connect dockside power to your boat outside North America unless you have purchased the International electrical conversion option, which is rated for 220-volt/50 Hertz. North American systems are rated for 110-volt/60 Hertz power.
- Use double insulated or three-wire protected electrical appliances when possible.

NOTICE

When using shore power, the simultaneous operation of several AC accessories can result in an overloaded circuit. It may be necessary to turn off one accessory while operating another.

Before connecting to shore power, ensure all breakers and switches on the AC master panel are in the OFF position. always attach the shore power cord to the boat inlet first; then to the dockside connection to prevent shock or injury from an accidental dropping of the “hot” cord into the water.

 **WARNING**

 **SHOCK/ELECTRICAL SYSTEM DAMAGE HAZARD!**

Monitor the electrical control panel’s polarity indicators when connecting shore power to your boat. A **GREEN** light illuminating after the power cord is plugged into the boat’s external power receptacle indicates acceptable electrical power in which you may energize the main breaker switches. A **RED** light, however, indicates reversed polarity, which could cause electrical system damage and possibly electrical shock injuries. In this case, **DO NOT** energize the main breaker switches. Instead, immediately disconnect the shore power cord (always from the dockside outlet first) and notify marina management.

Check for proper polarity as outlined in the warning above. Each dockside inlet is labeled line 1, line 2 or line 3 which corresponds to the line each operates on the AC master panel. Activate the AC system by turning the main ship/shore transfer switch to the DOCKSIDE position. Then turn on each line master-breaker and individual component breaker as required.

- Voltage on each line can be read by setting the voltmeter selector switch.
- Amperage draw can be read for each line on the line ammeter gauges.
- By using the paralleling switches, lines two and three can be used in conjunction with line 1.

NOTICE

When operating in the parallel mode, the total load is being supplied by line 1 and the amperage draw is monitored only on the line 1 ammeter gauge. Therefore, use caution when operating individual component breakers, so as not to exceed the rating of the line 1 inlet breaker.

Generator Power

Prior to initially operating your generator we strongly urge you to read the manufacturer's operating instructions included in the owner's packet. Polarity has been established in the installation of the generator, therefore the polarity lights will not function in this mode.

Always observe the following:

- Follow instructions in the generator manual for pre-start checks and break-in procedures.
 - The starter switch is located on the AC master panel on the starboard side of pilot house. The generator battery switch is located in the aft cabinet on the port side of the salon.
1. Open the generator seawater intake valve before starting the generator. The seawater intake valve must remain open during generator operation, and the seawater strainer should be checked frequently for leaks and/or debris.
 2. Operate the bilge blowers for a minimum of four minutes before starting the generator. Leave the blowers on while the generator is operating unless the yacht is running at cruising speed.
 3. **Diesel generator;** turn the pre-heat switch to the ON position and allow one minute for pre-heating. **Gas generator;** simultaneously press the oil pressure button and turn the starter switch until the generator starts.
 4. Turn the Starter switch to start, releasing it as soon as the generator starts. NEVER operate the starter for more than 30 seconds. If the generator does not start, wait at least 30 seconds before another start attempt is made.
- If your fuel system features a fuel management board (located under the steps next to the galley), fuel to run the generator is supplied from either the port or starboard fuel tanks (see the fuel system diagrams in the next section).

NOTICE

Environmental Hazard - If your boat features a diesel fuel system and a fuel management board; the generator fuel selector valves MUST be set so that return fuel is routed back to the same tank from which it was drawn. Otherwise, generator fuel drawn from a partially full tank and returned to a full tank may spill overboard through the tank venting system.

- If your fuel system does *not* feature a fuel management board, fuel to run the generator is supplied from the starboard fuel tank (see the fuel system diagrams in the next section).
- In addition to servicing the filters attached to the diesel generator, the filter/separator located near the fuel line valves should be serviced as described in the manufacturer's operating manual.
- The coolant mixture installed at the factory consists of equal parts of water and antifreeze (Ethylene Glycol). The coolant bottle is located on the port side of the cockpit (see photo on right). Oil pressure, water temperature, and voltage gauges are provided on, or adjacent to, the AC panel and monitor the engine functions of your generator.

To activate the AC system under generator power; switch the generator master circuit breakers to ON and then turn on each individual component breaker as required.

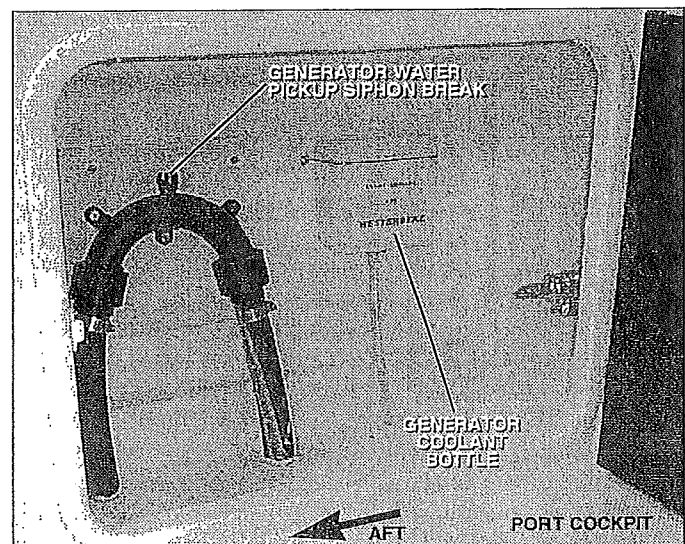

Fuel System

 **WARNING**

FIRE/EXPLOSION HAZARD - It is very important that the fuel system be inspected thoroughly the first time it is filled and at each subsequent filling. The **Fueling Instructions in the Owner's Manual** and the **Fuel Recommendations in the engine operation manual** must be followed.

 **CAUTION**

Air in the diesel supply system can stop an engine or severely restrict performance. If you suspect air in your diesel fuel lines, refer to your engine operation manual for detailed instructions on how to "bleed" the system.

 **CAUTION**

Avoid the storage or handling of gear near the fuel lines, fittings and tank.

Carefully read the Fuel Section of the engine operation manual included in your yacht's owner's packet. Give special attention to the subject of Fuel Recommendations. Filters/separators should be inspected periodically for debris and replaced as needed according to the instructions detailed in your engine manual, generator manual and in the filter literature supplied in your yacht's owner's packet.

Fuel Fills and Vents

Fuel fills are located on the side decks just aft of the bow rail. Fuel receptacle caps are marked "Diesel" or "GAS". Fuel vents are normally located in the hull or transom below and in the same general area as the fill. If you experience difficulty filling the fuel tank, check to see that the fuel fill and vent lines are free of obstructions and kinks.

Anti-siphon Valve (Only Gas Engine Fuel Systems)

An anti-siphon valve is an integral part of the fuel line barb fitting on each fuel tank. These valves are spring loaded and are opened by fuel pump vacuum. If a fuel line ruptures the valve prevents the siphoning of fuel from the tank.

 **WARNING**

FIRE/EXPLOSION HAZARD - If an engine problem is caused by fuel starvation, check the anti-siphon valve. If the valve is stuck or clogged, shut down the engine and replace it. Except in a crisis, **NEVER** operate the engines without the anti-siphon valve.

Fuel Management Board

Your yacht may or may not be equipped with a fuel management board.

- On models equipped with a fuel management board, fuel can be directed from either tank to the engines and generator using the supply valves. The fuel management board is located under the steps next to the galley.
- On models that are *not* equipped with a fuel management board, the port fuel tank provides fuel for the port engine while the starboard fuel tank provides fuel for the starboard engine *and* the generator.

Fuel Transfer Pump (Diesel Only)

Yachts without a fuel management board will be equipped with a fuel transfer pump. The fuel transfer pump is used to transfer fuel from a full tank to a nearly empty tank. The pump is activated by using the fuel transfer switch, located at the pilothouse helm station.

 **CAUTION**

Environmental Hazard! NEVER transfer fuel into a full (or nearly full) fuel tank. Fuel transferred into a full tank may spill overboard through the tank venting system.

Fuel Quality

Make sure your fuel suppliers are reputable and can be relied upon to furnish clean, high quality fuel. Once you have found such suppliers, keep your tank as full as possible with their fuel, allowing for expansion due to temperature variations. Then, if you are forced to add to the tank with a potentially poor quality supply, the portion of poor quality fuel will be minimized.

Fuel System Diagrams

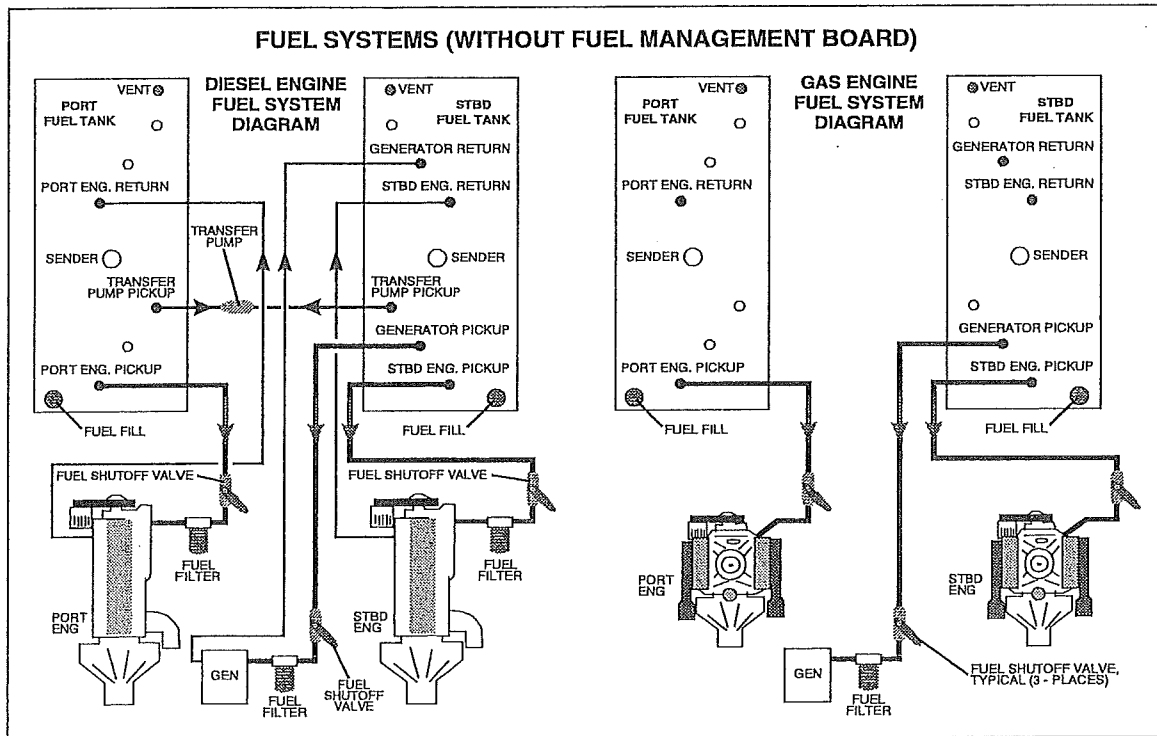
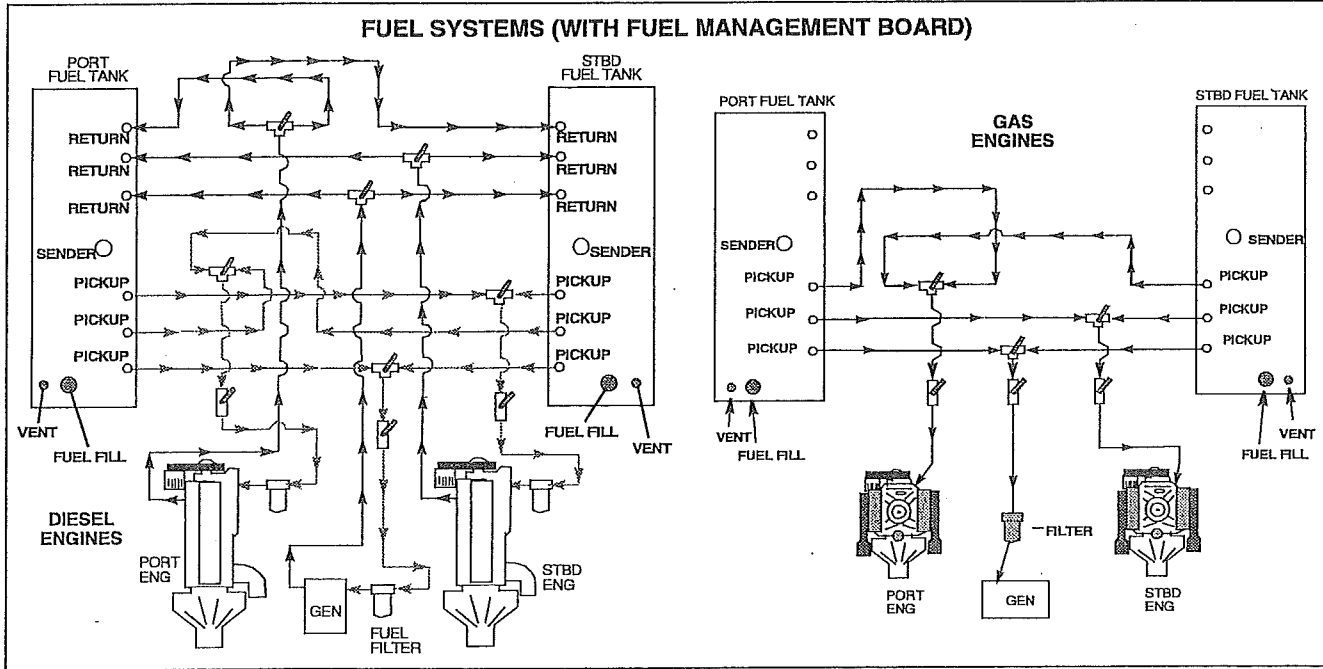

Engine Room Ventilation System

The bilge blowers remove fumes from the engine compartment and draw fresh air into the compartment through the deck vents. To ensure fresh air circulation, operate the bilge blowers for at least four minutes before starting the engines or generator, during starting, and while operating the yacht below cruising speed.

⚠ WARNING

 Operation of the blower system is **NOT A GUARANTEE** that explosive fumes have been removed. If you smell any fuel, **DO NOT** start the engine. If the engine is already running, immediately shut off the engine and all electrical accessories. Investigate immediately. **DO NOT** obstruct or modify the ventilation system.

Water Pickup Systems

The seawater strainers should be checked regularly for debris. The standard layout is one strainer for each engine, one for the generator and one for the air conditioning system (option). The strainers are located in the engine room.

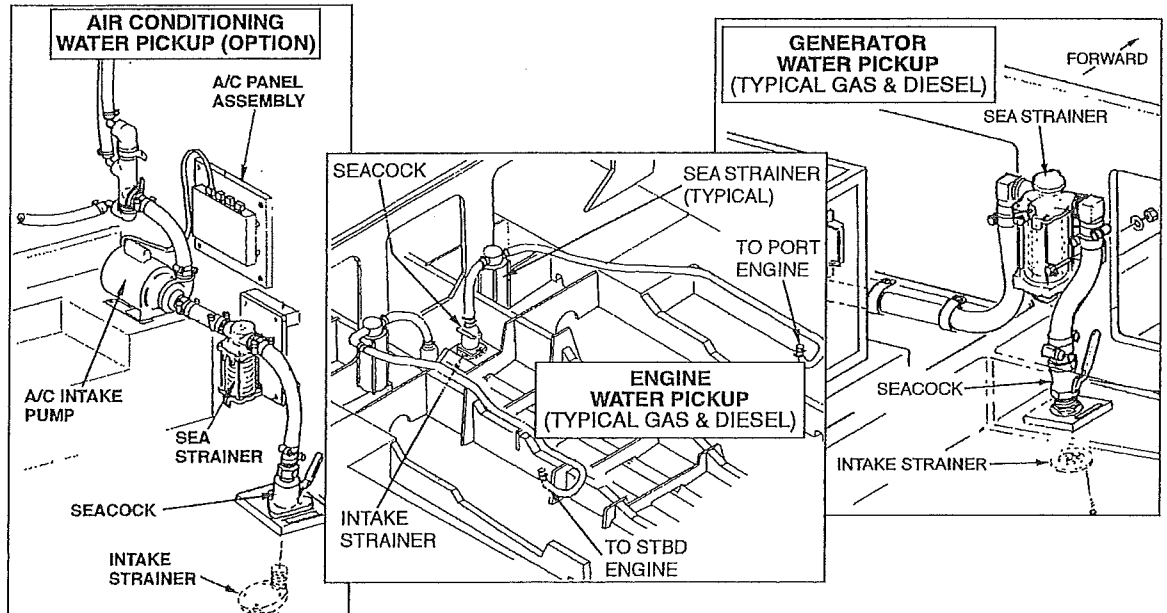

Exhaust Systems

The exhaust system is designed to keep water out of the engines in most sea conditions. However, **DO NOT** anchor stern to sea, and **DO NOT** shut off the engines if the seas are too high. Always use good seamanship and consider the sea conditions *before* anchoring or shutting off the engines.

Check all of the exhaust system clamps after the first 20 hours. Continue to check the clamps periodically after that.

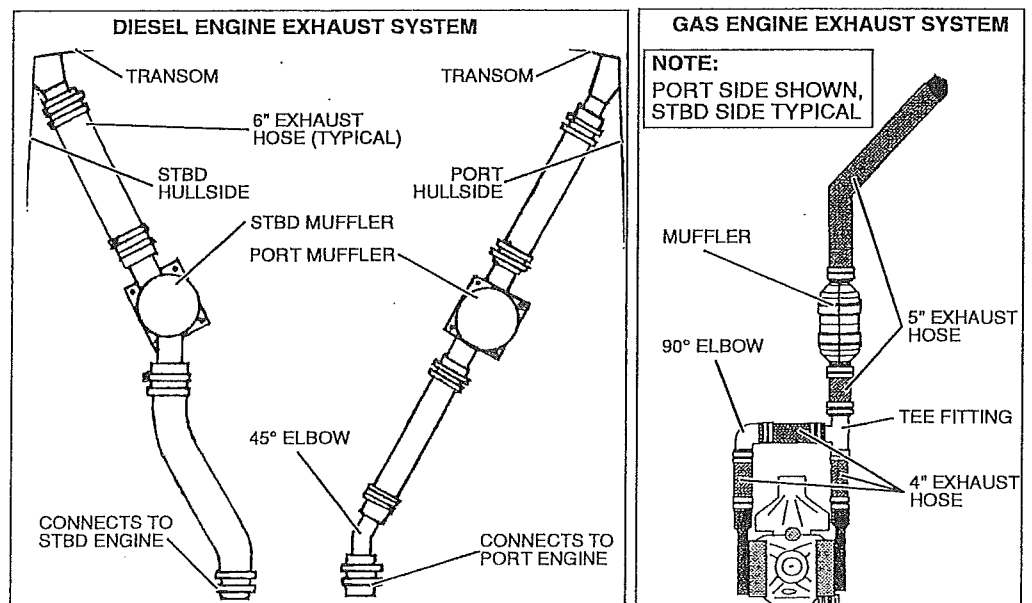

Shaft-Transmission Alignment

- Alignment between the engine transmission output shaft and the propeller shaft is critical. This alignment has been performed at the factory, and was rechecked by the dealer after the boat had been in the water for 48 hours.
- An alignment inspection should be performed as part of the routine maintenance program (after the initial 30 hours of operation, then every 60 hours) and whenever unusual noise or vibration is noticed.
- To insure proper alignment after a hallout or dry storage, wait 48 hours after launching before making final alignment adjustments.

Checking Alignment

Engine alignment requires moving the engine and should be performed by a marine mechanic. However, *checking* the alignment is relatively simple when these steps are followed:

1. Remove the flange bolts at the transmission-to-prop shaft coupling and slide the shaft aft until the flanges are about 1/4" apart.
2. Rotate the shaft to see if there is obvious "wobble" of the shaft flange. If there is, it may indicate shaft damage and should be inspected by a marine mechanic as soon as possible.
3. Move the shaft up and down and from side to side to determine, as closely as possible, the central position where the shaft is normally located. At this position, the transmission flange should align with the shaft flange without moving the shaft more than 1/8". If this is not the case, *a misalignment condition exists* (see CAUTION on right).
4. Move the shaft flange into contact with the transmission flange.
5. Check the gap between flange faces by trying to insert a 0.003" feeler gauge at the top, bottom and each side.
6. Repeat this operation after rotating the shaft flange 1/4 turn (3 times). If the feeler gauge can be easily inserted at any point, *a misalignment condition exists* (see CAUTION on right).
7. Reinstall the flange bolts, nuts and lock washers (if provided) and torque to the specifications listed to the right. Replacement bolts, nuts and washers *must* be corrosion resistant and grade 8 or better.

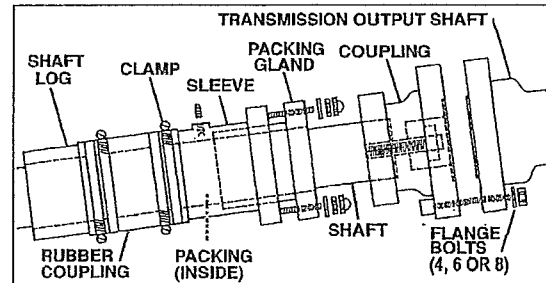

CAUTION

If misaligned, a qualified mechanic **MUST** perform an alignment as soon as possible. Continued use may lead to premature engine, transmission, shaft, shaft seal and/or hull damage.

BOLT SIZE	TORQUE
3/8" - 24	- 40 lbs. (+/- 7 lbs.)
7/16" - 20	- 65 lbs. (+/- 10 lbs.)
1/2" - 20	- 95 lbs. (+/- 15 lbs.)
5/8" - 18	- 200 lbs. (+/- 30 lbs.)
M16 x 1.5	- 175 lbs. (+/- 25 lbs.)

Shaft Log Stuffing Box Packing

The propeller shaft emerges from the bottom of the yacht through an opening called the shaft log. The shaft stuffing box is connected to the shaft log by a short length of special flexible hose. Packing rings are compressed around the shaft by the packing gland. The stuffing for the box prevents excessive amounts of water from leaking around the shaft and into the boat. Normal wear can cause stuffing box leakage to increase. Excessive leakage can usually be stopped by tightening the packing gland nuts slightly. **DO NOT** over tighten the packing gland nuts. A slight leak (up to 10 drops per minute while running) is normal and helps lubricate the packing and is therefore **NECESSARY**.

When stuffing box leakage becomes excessive, even after following the above steps, packing replacement can be performed as follows;

1. Remove the yacht from water.
2. Loosen the packing gland nuts and back the packing gland from the sleeve. Remove the old packing.
3. Wrap new packing around the shaft (4 rings, 3/16" for 1 1/2" shafts), then cut the rings with a razor blade at an angle approximately 30 degrees to the long axis of the shaft. Stagger the ends of each ring around the shaft and insure that the ring are at the bottom in the sleeve.
4. Tighten the packing gland nuts until resistance is felt.

When initially launched, the packing must be allowed to leak at a rate of 5 to 30 drops per minute, as it will expand and seal from water contact and friction heat from the turning shaft. Failure to allow this leak-off will result in packing burnout after a short period of time.

Steering System

Your yacht's steering system is manual hydraulic, not power steering. At no time should you expect this system to turn as easily as a car's power steering.

A rhythmic pulsing when turning the wheel is a characteristic of the pump and is not a malfunction. Also, when coming off a hard-over position, resistances may be felt, followed by a distinct sound. This is a normal situation resulting from the release of the check valve.

The fluid reservoir for the hydraulic steering system is located in the aft end of the engine compartment. Follow instructions in your yacht's owner's packet and on the reservoir. Check the fluid level and pressure regularity.

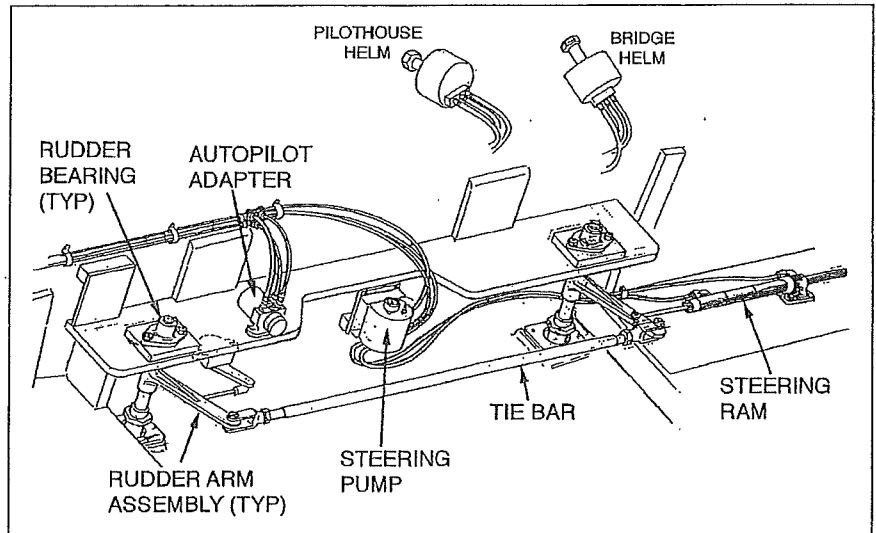

Rudder Stuffing Gland

The rudder stuffing gland is part of the assembly where the rudders emerge from the bottom of the boat. It is very similar to the propeller shaft stuffing box and will require the same maintenance. Since it does not receive the same wear as the propeller shaft, repacking is seldom required. This shaft stuffing gland should not leak any water.

Fresh Water System

The water filter, located in the utility room (access through the galley steps) should be inspected and cleaned often.

When connected to a dockside water supply, the DC power switch for the water pump should be turned OFF.

The water tank is equipped with a water level indicator in the AC/DC cabinet on the starboard side of the salon. It is always a good idea to top off the water tank at every opportunity to avoid the possibility of running short of fresh water.

A pressure accumulator tank is installed in the system. The pressure accumulator tank assists the pressure pump by reducing ON/OFF cycling and a more even flow of water.

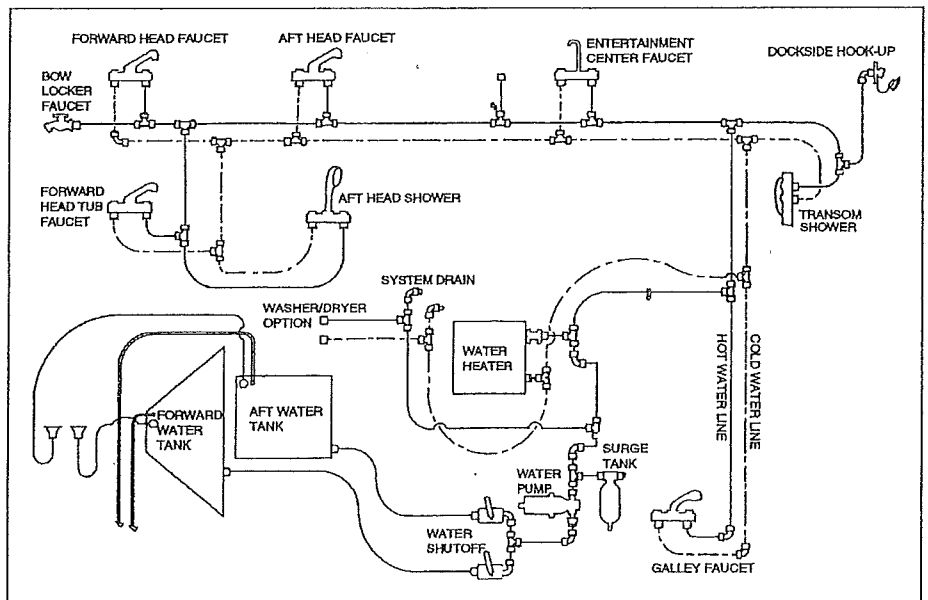

The water fill fittings are located on the port side of the forward deck. When your boat is to be left unattended for long periods of time, pump the water tank dry to prevent stored water from becoming stagnant and distasteful. Should it become necessary to disinfect the fresh water system, ask your dealer about treatment systems available and follow the manufacturer's instructions.

Water Heater

⚠ WARNING

SCALDING HAZARD! Water heated by the heat exchanger system can reach temperatures high enough to scald the skin. Use care when using hot water after running the port engine for any period of time.

WATER HEATER DAMAGE HAZARD! DO NOT energize the AC water heater electrical circuit until the heater is *completely* filled with water. Even momentary operation in a dry tank will damage the heating elements. Warranty replacements *will not* be made on elements or tank damaged in this manner. The tank is full if water flows from the tap when the hot water is turned on in the galley.

Please read the manufacturer's instructions supplied in your yacht's owner's packet. The water heater is connected to the AC power system. The water heater is located on the port side of the utility room. Access is gained through the galley steps.

Drain System

Sinks and showers ("gray water") drain overboard. Sinks above the waterline have gravity drains while the aft head sink and both showers are pump-drained. The drain sump pumps are located behind the sliding door on the starboard side at the forward end of the passageway.

Washdown Systems

The outlet for the freshwater washdown system is located on the starboard side of the cockpit. The outlets for the raw water washdown system (seawater) are located on the port side of the cockpit and the starboard side of the forward deck. Make sure the seacock is open before turning the raw water washdown system on.

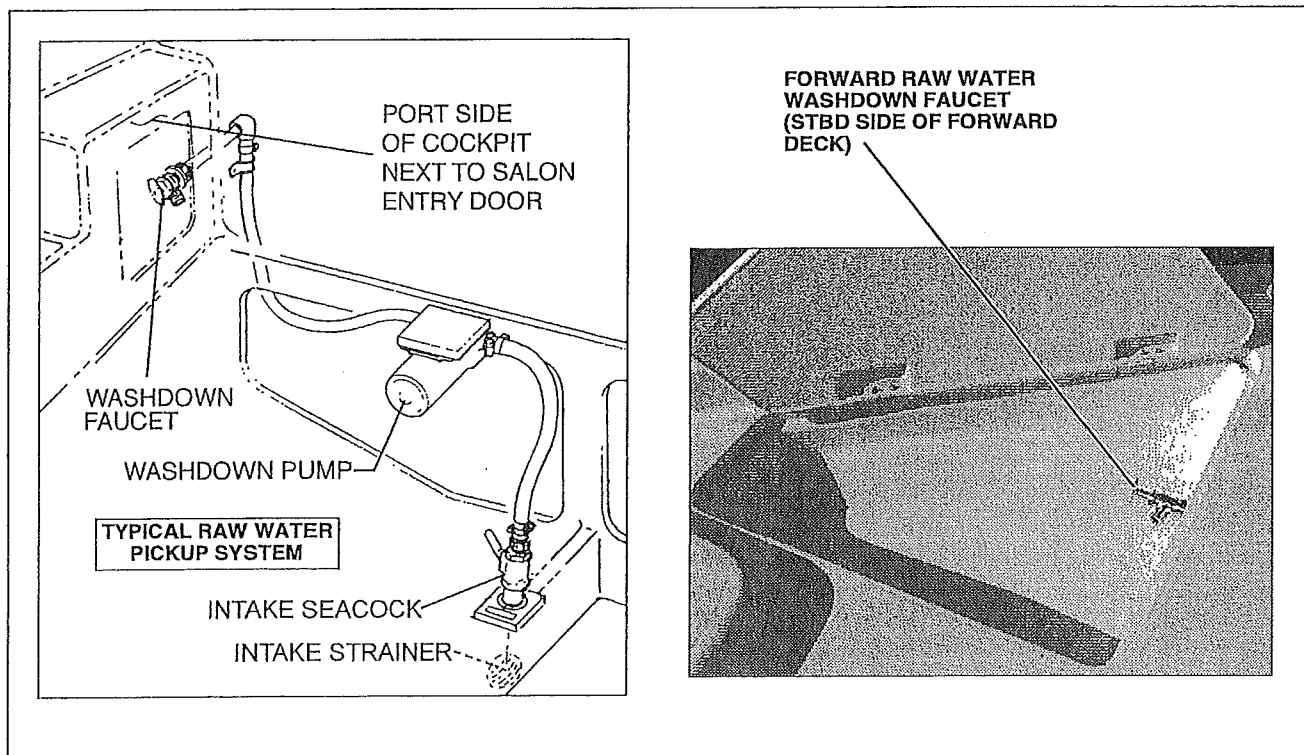

Bilge Pump System

Your yacht is equipped with six impeller-type bilge pumps. The bilge pumps are controlled by automatic bilge pump switches (autofloat switches) and/or switches on the dash panel.

The autofloat switches activate whenever water accumulates above a preset level in the bilge. They are wired directly to the battery and will normally function even when the yacht is completely shut down and unattended, such as when the yacht is moored at a marina.

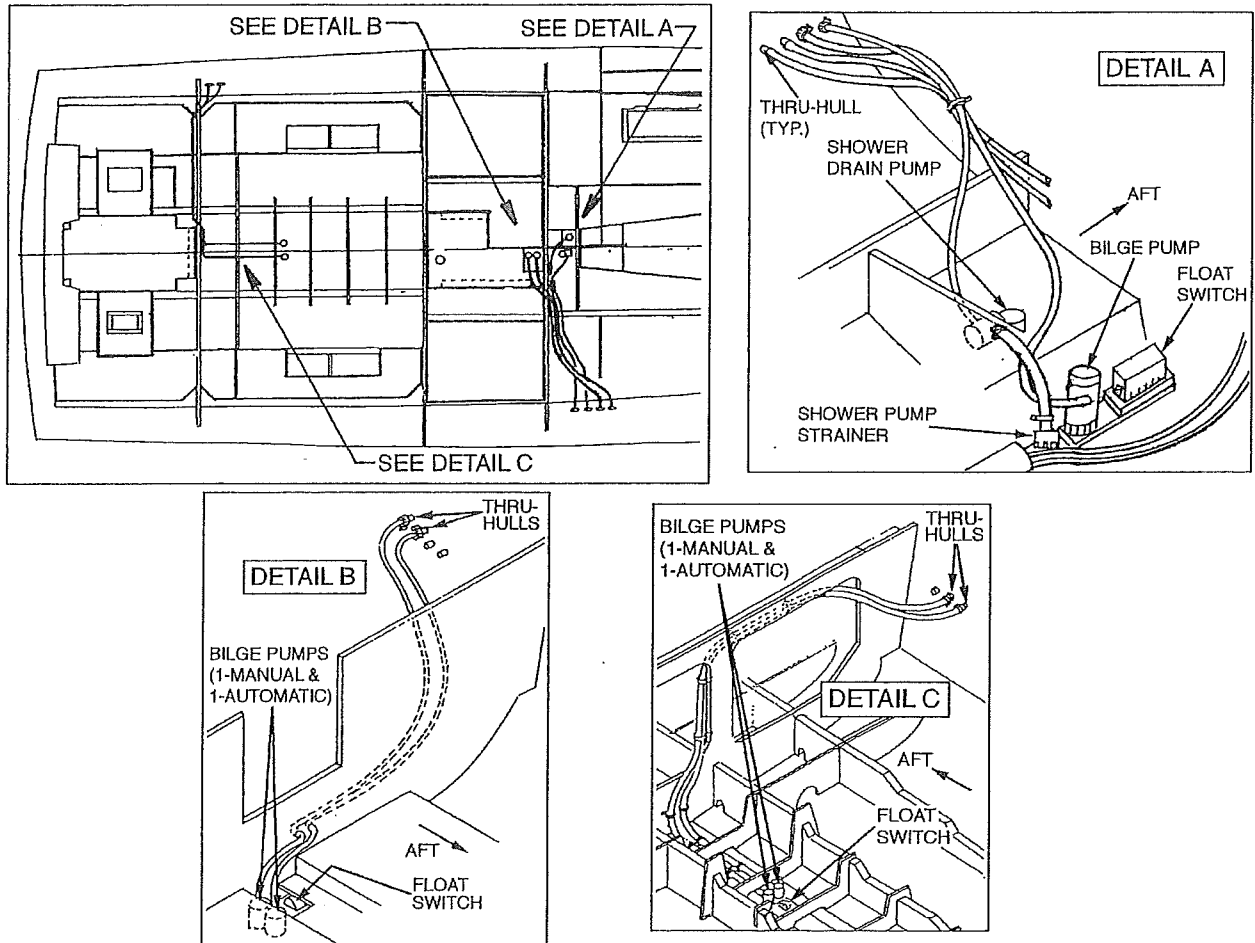

Bilge Pump Maintenance

Bilge pumps should be checked often to verify that they are working properly. Check each bilge pump by activating its dash-mounted switch. Verify that water in the bilge is pumped overboard. If bilge water is present and the pump motor is running but not pumping, inspect the discharge hose for a kink or collapsed area. If no problems are found, check the bilge pump housing for clogging debris as follows:

To remove the power cartridge:

1. Lift the tab while rotating the fins counter-clockwise and lift out the power cartridge (Fig. 1).
2. Clear the housing of debris.

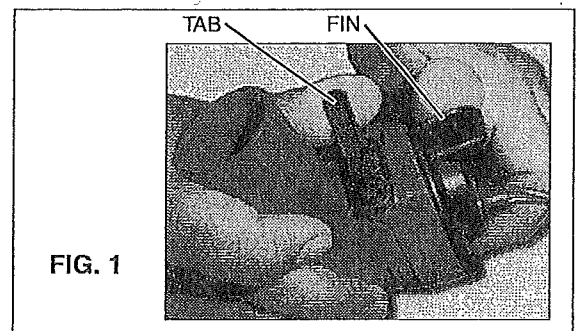

To reinstall the power cartridge:

1. Make sure the "O" ring is properly seated and coat the "O" ring with a light film of vegetable oil or mineral oil (Fig. 2).
2. Align the two cams on either side of the power cartridge with the two slots on the outer housing. Press the power cartridge into the housing and twist clockwise. Ensure proper reinstallation by attempting to twist the fins counter-clockwise without lifting the tab. The cartridge should stay in place.

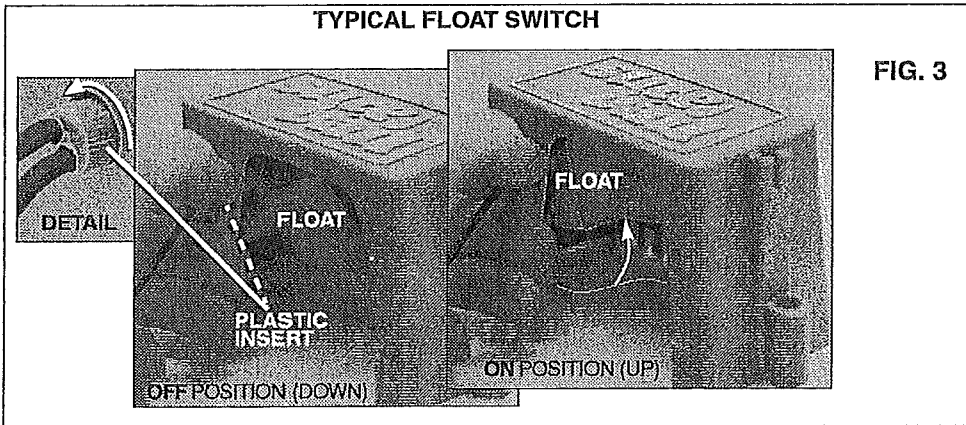
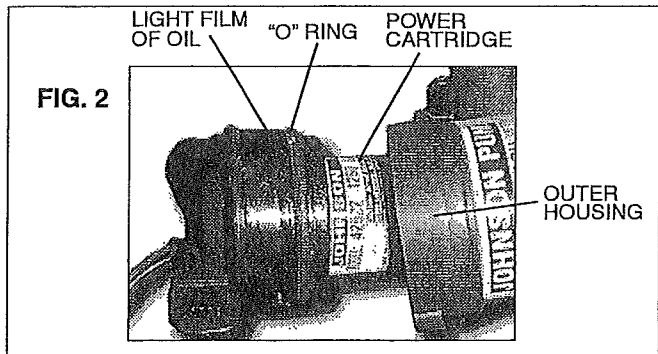

If applicable, the autofloat switch should also be checked often for proper operation. Lift the float by turning the plastic insert where the wires enter the housing, 1/4 turn counter-clockwise (Fig. 3).

As the float is lifted, the bilge pump should turn on. If lifting the float does not turn the pump on, check the inline fuse. If the fuse is good but the switch does not work, it may indicate a bad switch or possibly a low battery.

NOTICE

Discharge of oil, oil waste or fuel into navigable waters is prohibited by law. Violators are subject to legal action by the local authorities.

Marine Head System

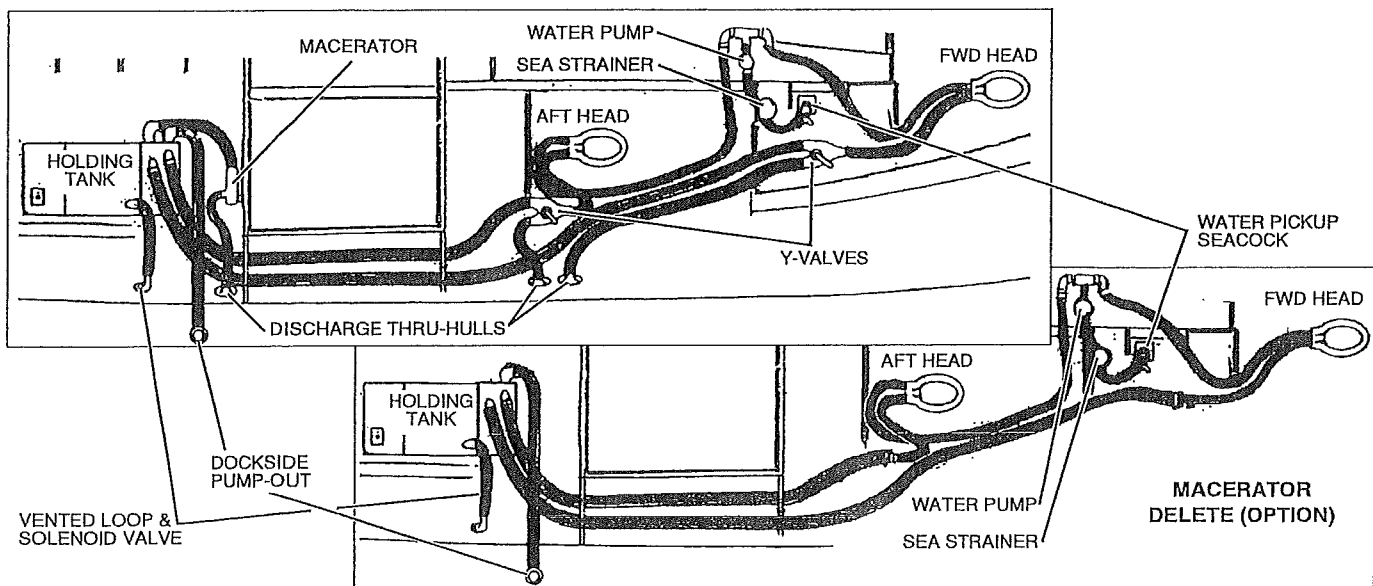

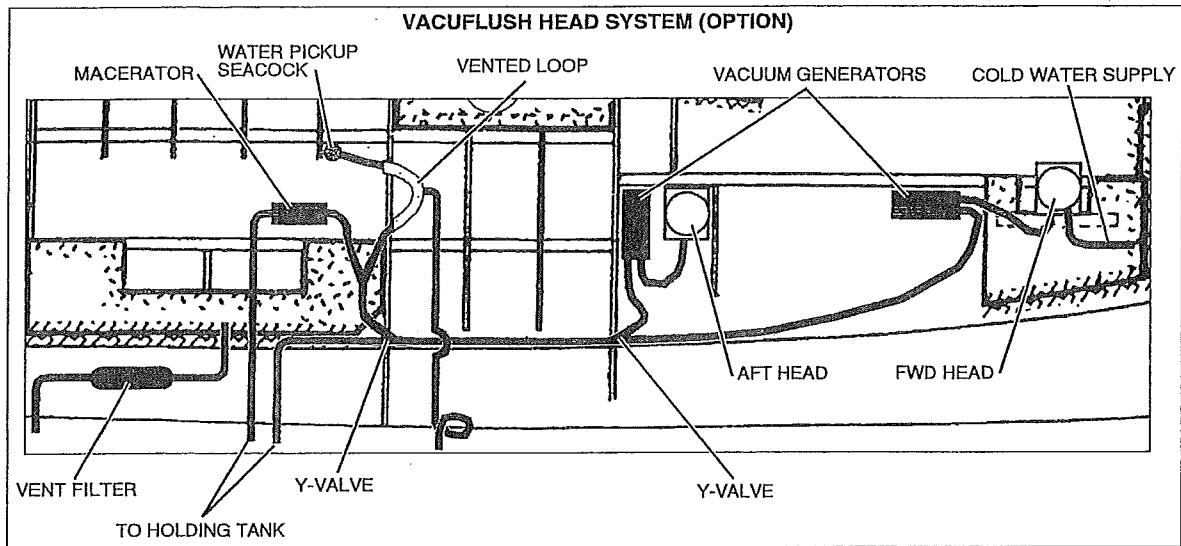

The marine head system is designed so that waste from either head may be flushed into the holding tank or overboard (where regulations permit). Routing is decided by the setting of the head “Y” valve. Access to the forward head “Y” valve is on the starboard side of the hallway in the vacuum cabinet at floor level. Access to the aft head “Y” valve is through the small door on the starboard bulkhead next to the galley steps.

The holding tank can be emptied by dockside pump-out or, where permitted, by actuating the macerator pump (with the discharge seacock open) from the pilothouse DC panel. The holding tank is located in the engine room, outboard of the starboard engine.

The holding tank on your motoryacht has a level indicator. Even so, it is advisable to empty the tank at every opportunity to reduce the possibility of problems which might be caused by an indicator error. The dockside discharge fitting is located about four feet aft of the fuel fill fitting on the starboard deck trail.

Check the local regulations regarding the legal use of marine head systems in your area.

Air Conditioning/Heating (Optional)

Your yacht may be equipped with an optional air conditioning system. Both heating and cooling are controlled from the same panel. Please refer to the manufacturer’s operating instructions included in your yacht’s owner’s packet.

110-Volt AC/12-Volt DC Refrigerator

Your yacht features 110-volt AC/12-volt DC refrigerators. Please read the manufacturer’s instructions supplied in your yacht’s owner’s packet. The refrigerators operate on 12-volt DC power unless 110-volt AC power is being supplied by the generator or shore power *and* the AC refrigerator breaker is ON.

NOTICE

In less than 24 hours, the refrigerators can render a 100-amp battery useless for engine starting. When operating on 12-volts, it is advised that the cold settings not be set higher than two (2). It is also advisable to turn off your refrigerators at night or when not in use. If you are going out for more than a day and cannot connect to dockside power, plan to run the engines or generator each day to maintain a charged battery.

Ice Maker

Make sure that the breaker switch located on the AC master panel is ON before attempting to use the ice maker. Detailed instructions can be found in the literature package.

Blender

Make sure that the breaker switch located on the AC master panel is ON before attempting to use the blender. Detailed instructions can be found in the literature package.

Range/Oven

Operating instructions are included in your yacht's owner's packet. Before attempting to operate the range/oven, make sure the breaker switch on the AC master panel is ON.

Microwave Oven

Before attempting to operate the microwave oven, make sure the breaker switch on the AC master panel is ON. Operating instructions for the microwave oven can be found in your yacht's owner's packet.

Trash Compactor

Make sure that the breaker switch located on the AC master panel is ON before attempting to use the trash compactor. Detailed instructions can be found in the literature package.

Washer/Dryer (Optional)

Access to the washer/dryer is on the port side of the hallway, forward of the aft stateroom. Before attempting to operate the washer/dryer, make sure that the breaker switch, located on the AC master panel, is ON. Further operating instructions are included in the literature package. Access to the lint trap is through the outboard cabinet door of the hanging locker in the mid stateroom.

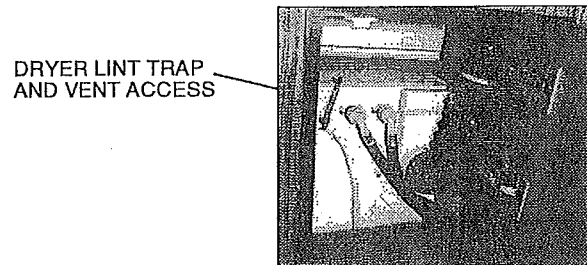

Vacuum System

Operating instructions are included in your yacht's owner's packet. Before attempting to operate the vacuum system, make sure the breaker switch on the AC master panel is ON. The vacuum hose inlet receptacle is located behind the aft sliding door of the cabinet on the starboard side of the hallway.

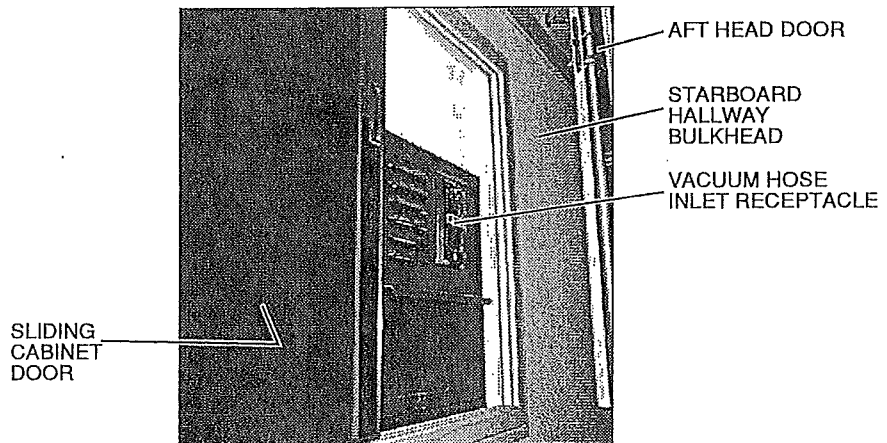

Audio/Video Equipment

The standard and optional audio/video equipment on your yacht have separate brochures explaining their operating features. Note that AM radio reception may be impaired anytime the engine is running.

CHAPTER 4: WIRING DIAGRAMS

Standard Dual Dockside

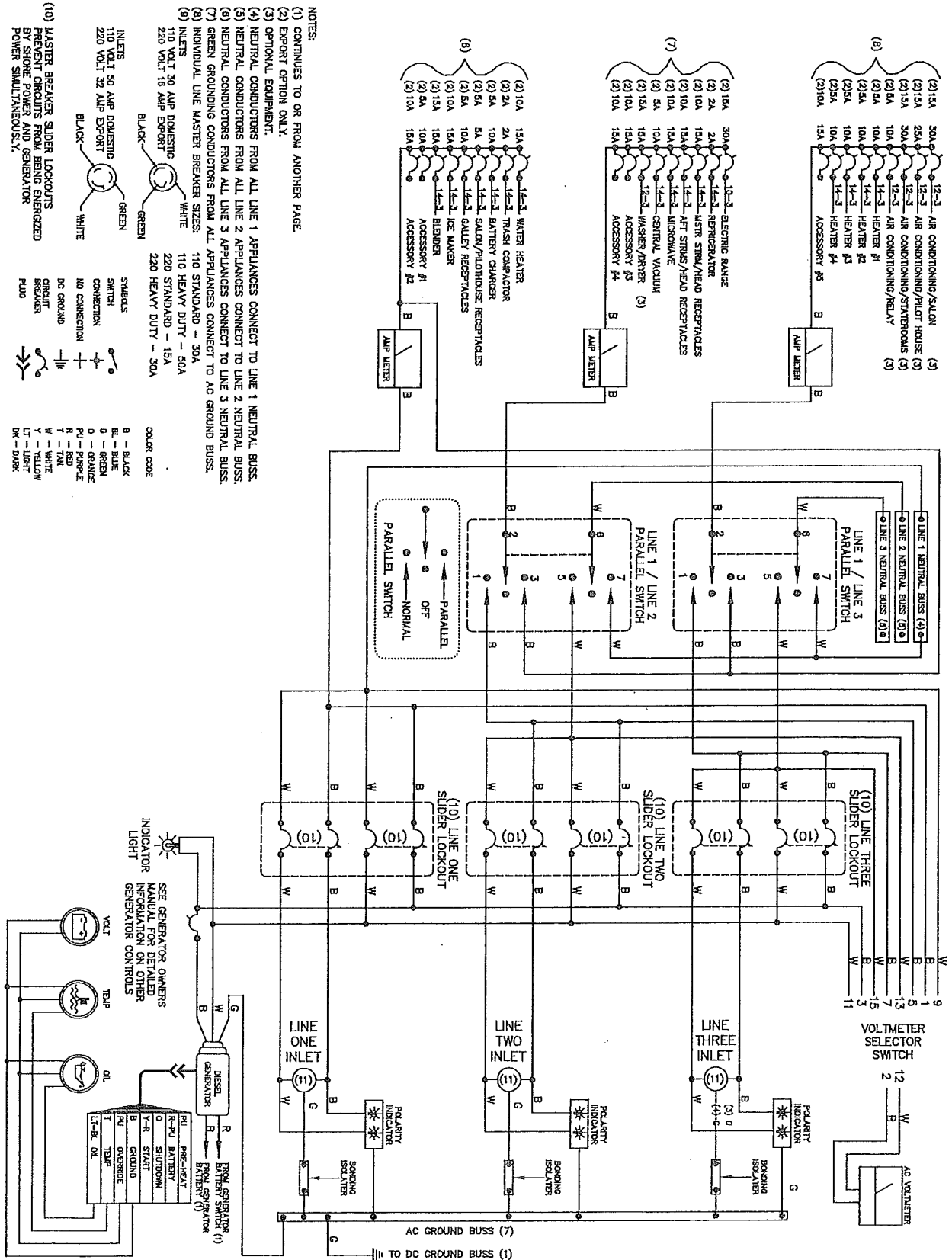

Accessory DC Circuits

DC MAIN DISTRIBUTION PANEL (1)

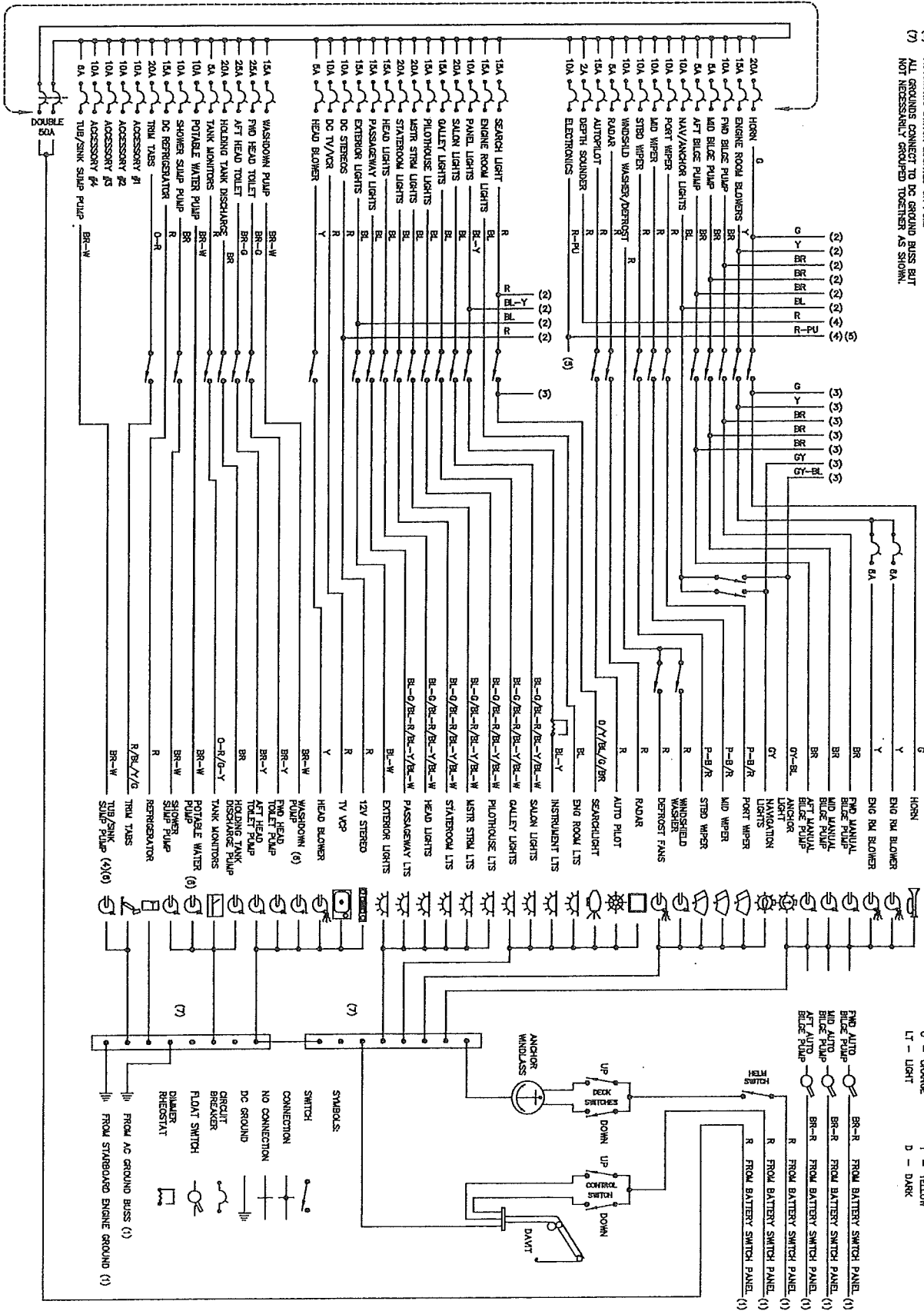

Gas Engine Electrical System

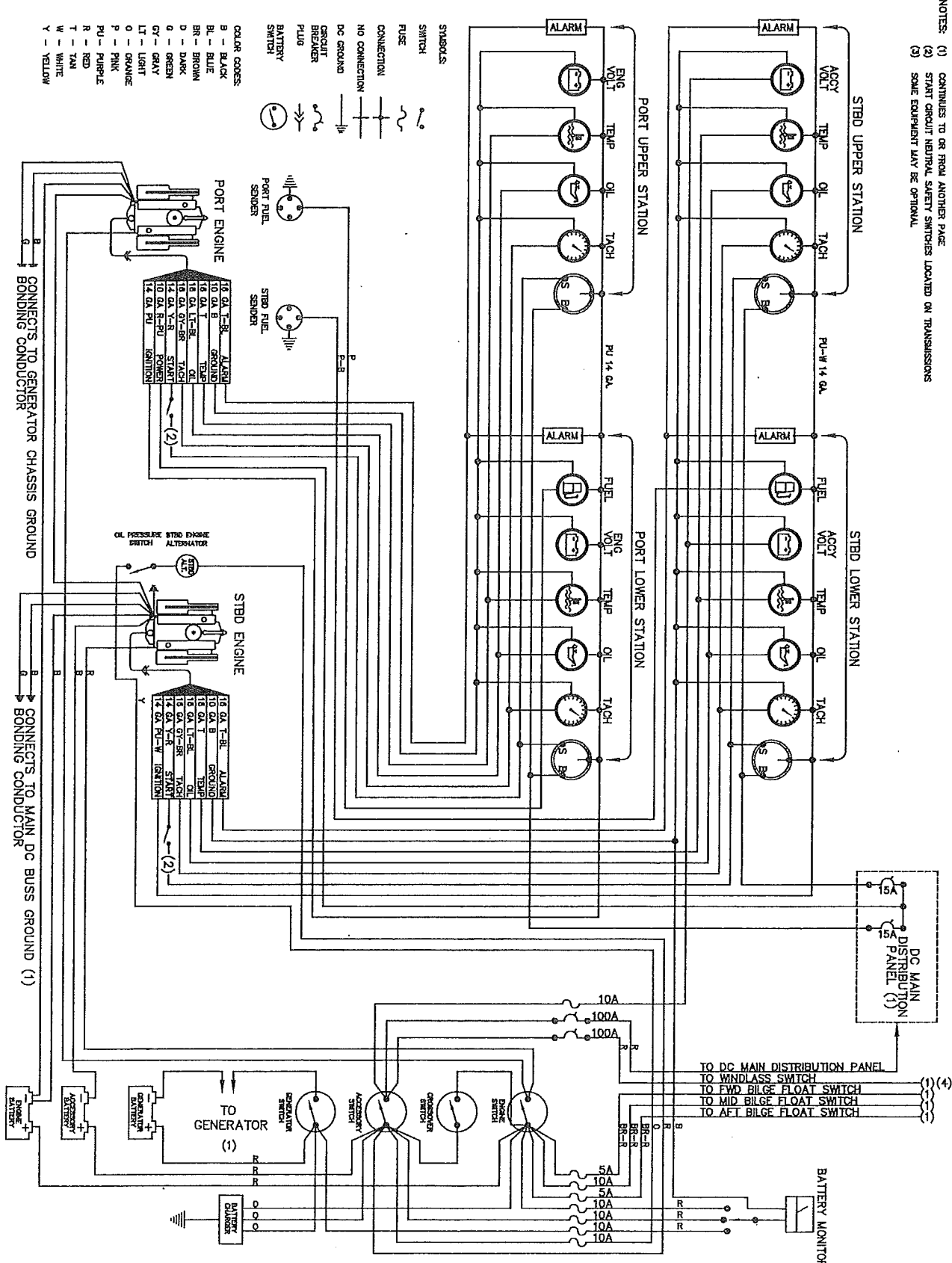

- SYMBOLS:**
- SWITCH
 - FUSE
 - CONNECTION
 - NO CONNECTION
 - DC GROUND
 - CIRCUIT BREAKER
 - PLUG
 - BATTERY
- COLOR CODES:**
- B - BLACK
 - BL - BLUE
 - BR - BROWN
 - D - DARK
 - G - GREEN
 - GY - GRAY
 - LT - LIGHT
 - O - ORANGE
 - P - PINK
 - PU - PURPLE
 - R - RED
 - T - TAN
 - W - WHITE
 - Y - YELLOW

NOTES: (1) CONTINUES TO OR FROM ANOTHER PAGE
 (2) START CIRCUIT NEUTRAL SAFETY SWITCHES LOCATED ON TRANSMISSIONS
 (3) SOME EQUIPMENT MAY BE OPTIONAL

CONNECTS TO GENERATOR CHASSIS GROUND
 CONNECTS TO MAIN DC BUSS GROUND (1)

Diesel Engine Electrical System

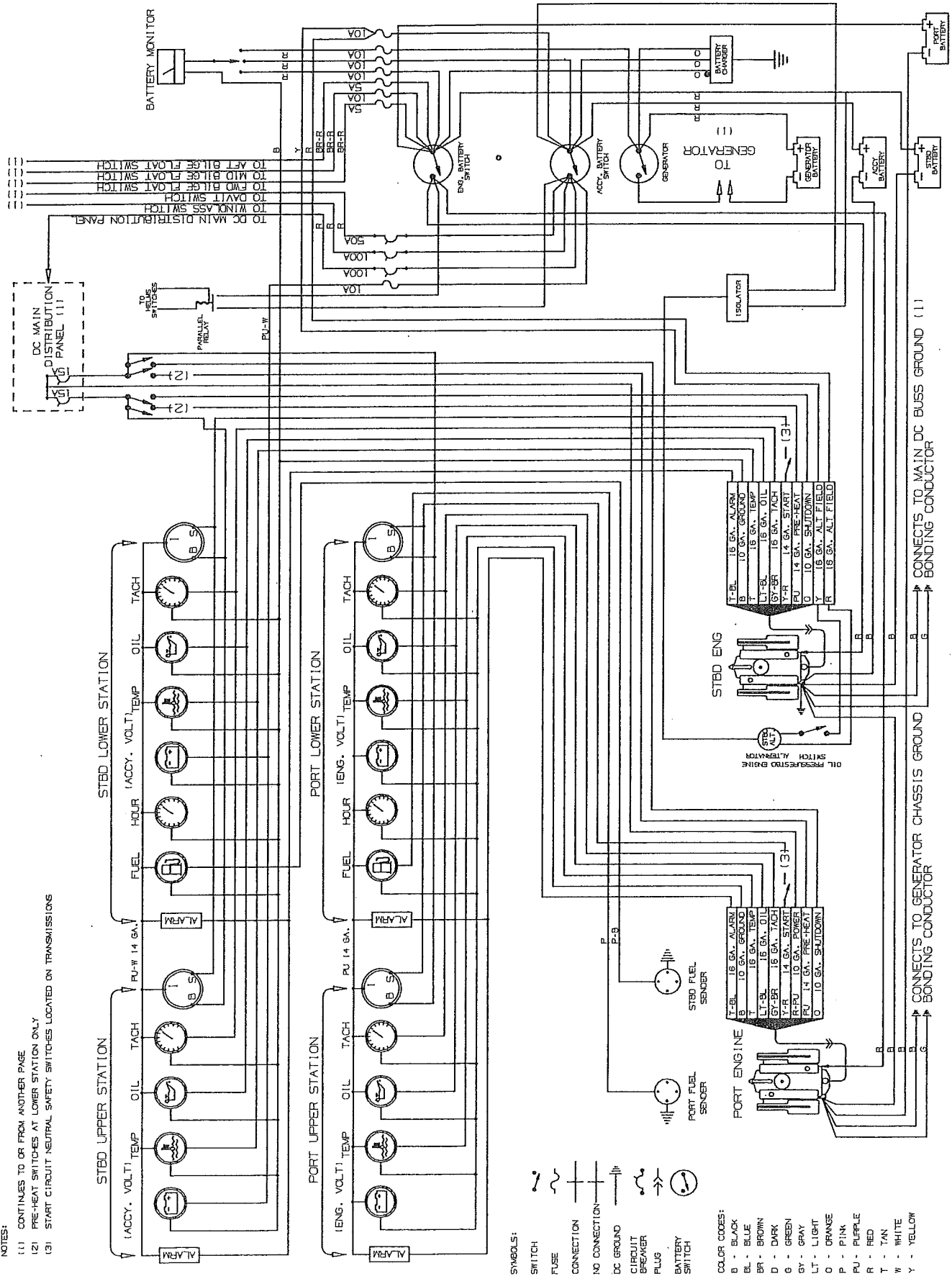

- NOTES:
- (1) CONTINUES TO OR FROM ANOTHER PAGE
 - (2) PRE-HEAT SWITCHES AT LOWER STATION ONLY
 - (3) START CIRCUIT NEUTRAL SAFETY SWITCHES LOCATED ON TRANSMISSIONS

- SYMBOLS:**
- SWITCH
 - FUSE
 - CONNECTION
 - NO CONNECTION
 - DC GROUND
 - CIRCUIT BREAKER
 - PLUG
 - BATTERY SWITCH
- COLOR CODES:**
- B - BLACK
 - BL - BLUE
 - BR - BROWN
 - D - DARK
 - G - GREEN
 - GR - GRAY
 - LT - LIGHT
 - O - ORANGE
 - P - PINK
 - PU - PURPLE
 - R - RED
 - T - TAN
 - W - WHITE
 - Y - YELLOW

EXPRESS LIMITED WARRANTY

BAYLINER MARINE CORPORATION, EXPRESS LIMITED WARRANTY

Limited Warranty for New 2000 or 2001 Model Year Motoryachts (3388, 3788, 3988, 4087, 4788, 5288 and 5788)

Bayliner warrants to the first retail purchaser ("Owner") of a new 2000 or 2001 Model Year Bayliner Motoryacht (3388, 3788, 3988, 4087, 4788, 5288 and 5788) purchased from an authorized dealer, operated under normal, noncommercial use, that the selling dealer will (or, in Bayliner's discretion, it will):

- (1) repair or replace any parts found to be defective in materials and workmanship occurring within 1 (one) year of the date of delivery;
- (2) repair any defects in materials and workmanship in structural fiberglass parts of the hull (and specifically excluding the deck) occurring within 7 (seven) years of the date of delivery; and
- (3) repair any defects in materials and workmanship that result in osmotic blistering of the exterior gel coat surface of the hull laminate occurring within 5 (five) years of the date of delivery, *except that Bayliner shall not be liable or responsible to correct, repair, or replace any damage from osmotic blistering if the original gel surface has been altered in any way, including repair or application of any coating other than marine anti-fouling bottom paint or improper surface preparation for paint, or excessive sanding or sandblasting.* Bayliner shall repair osmotic blisters based upon customary and reasonable charges with the method and extent of repair subject to Bayliner's prior approval.

Owner's sole and exclusive remedy for defects covered by this limited warranty shall be the repair or replacement, at the option of Bayliner, of the defective part or component. **THE REMEDY DESCRIBED IN THIS LIMITED WARRANTY SHALL BE THE SOLE AND EXCLUSIVE REMEDY PROVIDED BY BAYLINER.**

Terms and Conditions

This limited warranty is subject to the specific terms and conditions set forth below.

In order to receive this limited warranty coverage, Bayliner must receive the limited warranty registration card from the authorized selling dealer within 30 days of delivery of the Motoryacht. Receipt by Bayliner of the limited warranty registration card is a condition to the processing of a warranty claim.

All repairs under the terms of this warranty are subject to pre-approval from Bayliner service personnel. Employees of Bayliner dealers are not authorized to make warranties or approve warranty repairs other than those set forth herein.

To obtain warranty service, the Motoryacht, including any allegedly defective part, must be returned to the authorized Bayliner dealer from whom the Motoryacht was purchased within the applicable warranty period. All warranty repairs must be performed at the Bayliner dealer's facilities or, at Bayliner's discretion, at an authorized Bayliner repair facility.

The Owner is responsible for all expenses associated with transporting the Motoryacht and/or defective part to and from the Bayliner dealer, expenses associated with haul outs, yard fees, and any other expenses associated with transferring the yacht to the Bayliner dealer or authorized Bayliner repair facility for warranty service.

What Is Not Covered

Bayliner shall not be responsible for any condition that may be affected by the Owner's failure to use, maintain, or store the Motoryacht as specified in the Bayliner owner's manual, and any other failure to provide reasonable care and maintenance.

Bayliner hereby assigns all warranties provided by the manufacturers and distributors of components and parts (including but not limited to engines, transmissions, outdrives, and appliances) for the Motoryacht to the Owner and Owner's sole remedy for defects in components or parts subject to those warranties shall be the assertion of Owner's rights against those manufacturers or distributors.

Bayliner shall have no liability or responsibility for any damage or expense, and no Bayliner warranty is provided for, the following:

A Motoryacht purchased from any party other than an authorized Bayliner dealer; a Motoryacht, including components and systems, that has been altered or modified from factory specifications; equipment and accessories (including engines) not factory installed by Bayliner; a Motoryacht used for commercial purposes; any components or parts (including but not limited to engines, transmissions, outdrives, and appliances) that carry their own warranties; damage or deterioration of cosmetic surface finishes, including cracking, crazing, discoloration, air voids, fading or oxidation of gel coat, wood finishes (varnishes, stains and paints), fabrics, vinyls, plastics, plated or painted metal and stainless steel finishes; anti-fouling bottom paint or zinc anodes; the cost to remove, disassemble or reinstall components not installed by Bayliner that require removal to access parts covered by this warranty; a Motoryacht which has been misused, operated in a negligent manner, used for racing or military purposes; operated without normal maintenance, operated contrary to any instructions furnished by Bayliner or its component suppliers, or operated in violation of applicable law or regulations; any representation or implication relating to speed, range, fuel consumption or estimated performance characteristics; window glass and windshield damage or breakage; damage, shrinkage, or deterioration of carpet, upholstery and exterior canvas tops, enclosures, and weather covers (including rainwater leakage); and any damage, cost, or expense caused by an act of nature.

Other Limitations

IN NO EVENT SHALL BAYLINER OR THE SELLING DEALER BE RESPONSIBLE FOR INDIRECT, INCIDENTAL, OR CONSEQUENTIAL DAMAGES (including but not limited to loss of time, loss of use, inconvenience, travel expense, transportation costs, towing, damage or loss of use of other property or equipment, loss of profits, and loss of contracts), WHETHER SUCH CLAIM OR ACTION IS BASED ON CONTRACT, WARRANTY, NEGLIGENCE, STRICT LIABILITY OR ANY OTHER TORT. Some states do not allow the exclusion of incidental or consequential damages, so the above limitation or exclusion may not apply to you.

This warranty gives the Owner specific legal rights, and the Owner may also have other rights which vary from state to state. This document contains the entire warranty given by Bayliner and there are no terms, promises, conditions or warranties, express or implied, other than those contained herein. **ALL OTHER WARRANTIES, EXPRESS OR IMPLIED, INCLUDING IMPLIED WARRANTIES OF FITNESS AND MERCHANTABILITY ARE EXPRESSLY EXCLUDED. TO THE EXTENT ALLOWED BY LAW, ANY IMPLIED WARRANTY OF MERCHANTABILITY IS LIMITED TO THE DURATION OF THIS WRITTEN WARRANTY.** Some states do not allow limitations on how long an implied warranty lasts, so the above limitations may not apply to you. Bayliner specifically does not authorize any person to extend the time or scope of this warranty or to create or assume for Bayliner any other obligation or liability with respect to Bayliner Motoryacht.

Transferability

The unexpired portion of this warranty may be transferred to a second owner upon purchase of the Motoryacht from an authorized Bayliner dealer. A non-refundable recording fee of \$250.00 must accompany any transfer request. Bayliner reserves the right to reject a warranty transfer request for a Motoryacht that has been damaged, neglected, or otherwise previously excluded from warranty. Bayliner will confirm all warranty transfers in writing to the dealer and the second owner.

For further information regarding this limited warranty, please contact Bayliner at:

Bayliner Marine Corporation
P.O. Box 9029
Everett, WA 98206
Phone (360) 435-5571

