

BAYLINER®

4788 Pilot House Motoryacht

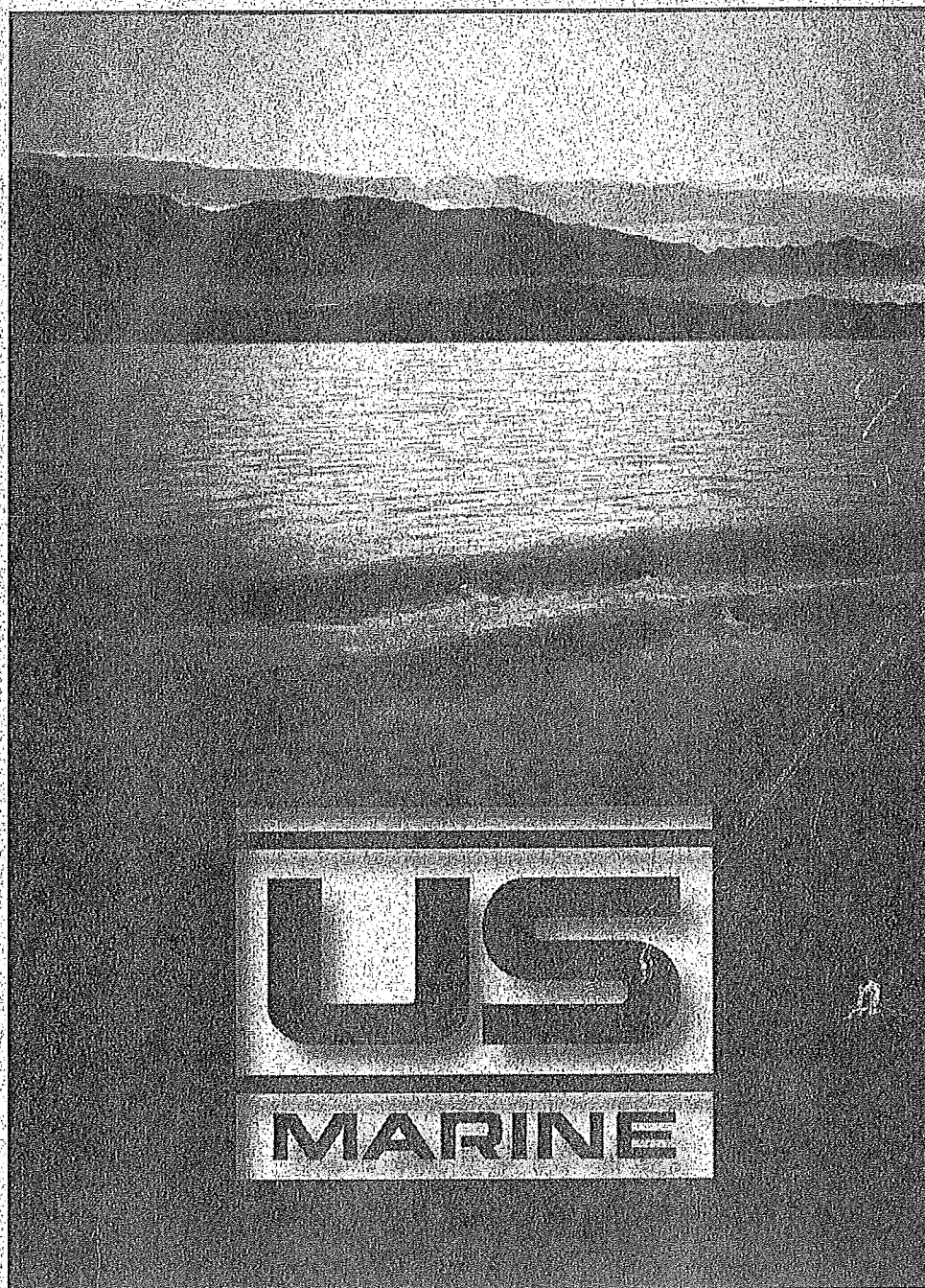

Owner's Manual Supplement



To Be The Best For Total Customer Satisfaction

Congratulations and welcome aboard your new Bayliner Motoryacht! Thank you for choosing our product. Bayliner, a division of US Marine, is committed to the goal of building the highest quality products in the marine industry and to providing the finest after-the-sale support in the world.

To keep our respected status as the number one boat builder in the world, US Marine has instituted an ongoing **Total Customer Satisfaction Program**. The guiding principles of this program are:

- Design, build and support the finest marine products in the world, in every market we serve.
- Be personally and individually responsible for the customer's total satisfaction.
- Remember that every customer has a choice, and we want them to choose US Marine!

Welcome to the US Marine family. We are looking forward to serving your boating needs, now and in the future!

BAYLINER *a division of US Marine, a Brunswick Company*

Hull Identification Number: _____

Port Engine Serial Number: _____

Stbd. Engine Serial Number: _____

Hull Identification Number

The Hull Identification Number (HIN) is located on the starboard side of the transom. Record the HIN and the engine serial numbers in the space provided above. Please refer to the HIN for any correspondence or orders.

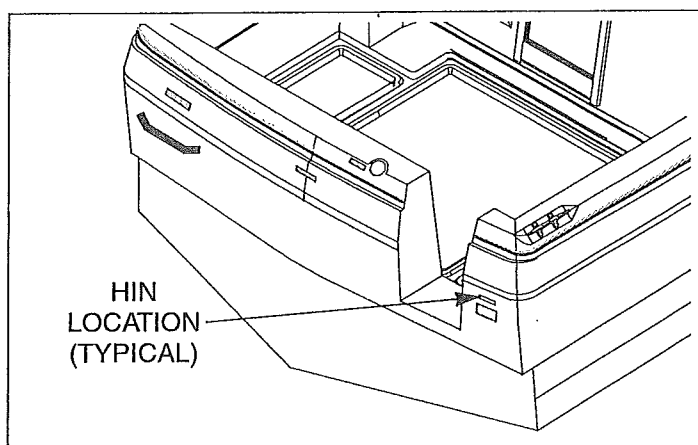

© 1998 Bayliner Technical Publications. All rights reserved.

No part of this publication may be reproduced, stored in any retrieval system, or transmitted in any form by any means, electronic, mechanical, photocopying, recording or otherwise, without prior written permission of Bayliner. Printed in the United States of America.

General Notes

The material in this document is for information only and is subject to change without notice. While reasonable efforts have been made in the preparation of this document to assure its accuracy, Bayliner assumes no liability resulting from errors or omissions in this document, or from the use of information contained herein.

Due to our commitment to product improvement, Bayliner reserves the right to make changes in the product design, specifications, and equipment at any time without notice or obligation. Illustrations and/or photos may show optional equipment.

All Bayliner products meet or exceed USCG and/or NMMA construction standards. Manufactured with 1,1,1 Trichloroethane, a substance which harms public health and environment during the manufacturing process by destroying ozone in the upper atmosphere.

Proprietary Rights

This document discloses subject matter in which Bayliner has proprietary rights. The information and design disclosed herein were originated by and are the property of Bayliner. Neither receipt nor possession thereof confers or transfers any right to reproduce, copy, alter or disclose the document or any part thereof, any information contained therein, or to construct boats or any item from it, except by written permission from or written agreement with Bayliner. This document is to be returned upon request to Bayliner.

CONTENTS

CHAPTER 1: ABOUT THIS MANUAL

- 1 Dealer Service
- 1 Boating Experience
- 1 Engine/Accessories Guidelines
- 1 Structural Limitations
- 1 Safety Standards
- 2 Qualified Maintenance
- 2 Hazard Warning Symbols

CHAPTER 2: PRODUCT DESCRIPTION

- 3 Dimensions and Capacities
- 3 Layout View
- 3 Lifting Sling Positions
- 4 Hull Exterior Hardware

CHAPTER 3: COMPONENTS / SYSTEMS

- 5 VHF Radio
- 5 Radar
- 5 Autopilot
- 5 Depth Finder
- 5 Compass
- 5 Trim Tabs
- 6 Anchor Windlass
- 6 Spotlight
- 6 Windshield Wipers
- 6 Davit
- 7 Electrical System
- 8 12-Volt DC System
 - 8 *Fuses and Circuit Breakers*
 - 8 *Battery Switches*
 - 8 *Batteries*
 - 8 *Engine Alternators*
 - 8 *Battery Charger*
- 8 110-Volt AC System
 - 9 *Shore Power*
 - 10 *Generator Power*
- 11 Fuel System
 - 11 *Fuel Fills and Vents*
 - 11 *Fuel Management Board*
 - 11 *Fuel Transfer Pump (Diesel Only)*
 - 12 *Fuel Quality*
 - 12 *Fuel System Diagrams*

- 13 Engine Room Ventilation System
- 13 Water Pickup Systems
- 13 Exhaust Systems
- 14 Shaft-Transmission Alignment
 - 14 *Checking Alignment*
- 14 Shaft Log Stuffing Box Packing
- 15 Steering System
 - 15 *Rudder Stuffing Gland*
- 15 Fresh Water System
 - 16 *Water Heater*
 - 16 *Drain System*
- 16 Washdown Systems
- 17 Bilge Pump System
 - 17 *Bilge Pump Maintenance*
- 18 Marine Head System
- 19 Air Conditioning/Heating (Optional)
- 19 110-Volt AC/12-Volt DC Refrigerator
- 19 Ice Maker
- 20 Blender
- 20 Range/Oven
- 20 Microwave Oven
- 20 Trash Compactor
- 20 Washer/Dryer (Optional)
- 20 Vacuum System
- 20 Audio/Video Equipment

CHAPTER 4: WIRING DIAGRAMS

- 21 Standard Dual Dockside
- 22 Accessory DC Circuits
- 23 Gas Engine Electrical System
- 24 Diesel Engine Electrical System

CHAPTER 5: ISO SYMBOLS

- 25 Definitions

LIMITED WARRANTY

- 27 What Is Not Covered
- 27 Other Limitations
- 27 Your Obligation

CHAPTER 1: ABOUT THIS MANUAL

This Owner's Manual Supplement was prepared to provide specific information about your yacht. Please study this supplement and the Owner's Manual carefully, paying particular attention to the LIMITED WARRANTY section. Keep this supplement in a secure place and hand it over to the new owner when you sell the boat.

Dealer Service

Make certain that you receive a full explanation of all systems from the selling dealer before taking delivery of your yacht. Your selling dealer is your key to service. If you experience any problems with your new yacht, immediately contact the selling dealer. If for any reason your selling dealer is unable to help, you can call us direct on our customer service hotline: 360-435-8957 or send us a FAX: 360-403-4235

Boating Experience

If this is your first boat or if you are changing to a type of boat you are not familiar with, for your own comfort and safety, please ensure that you obtain handling and operating experience before assuming command of the yacht.

We strongly recommend that you take one of the boating safety classes offered by the U.S. Power Squadrons (<http://www.usps.org/>) or the U.S. Coast Guard Auxiliary (<http://207.201.180.170/>). For more course information, including dates and locations of upcoming classes, visit their web sites or call their local offices.

Outside the U.S., your selling dealer, national sailing federation or local yacht club can advise you of local sea schools or competent instructors.

 WARNING
<p>CONTROL HAZARD - A qualified operator must be in control of the yacht at all times. DO NOT operate your yacht while under the influence of alcohol or drugs.</p>

Engine/Accessories Guidelines

Your yacht's engines and accessories were selected to provide optimum performance and service. Installing different engines or other accessories may cause unwanted handling characteristics. Should you choose to install different engines or to add accessories that will affect the boat's running trim, have an experienced marine technician perform a safety inspection and a handling test before operating your yacht by yourself again.

Structural Limitations

The command bridge, transom platform and bow platform are designed to be lightweight for proper boat balance. The load limit for these platforms and the command bridge is 30 pounds per square foot, evenly distributed.

Safety Standards

Your yacht's mechanical and electrical systems were designed to meet safety standards in effect at the time it was built. Some of these standards were mandated by law. All of them were designed to insure your safety, and the safety of other people, vessels and property.

Please read the Owner's Manual for important safety standards and hazard information.

 DANGER
<p>PERSONAL SAFETY HAZARD - DO NOT allow anyone to ride on parts of the yacht not designated for such use. Sitting on seat backs, lounging on the forward deck, bow riding, gunwale riding or occupying transom platform while underway is especially hazardous and will cause personal injury or death.</p>

Qualified Maintenance

WARNING

To maintain the integrity and safety of your yacht, only qualified personnel should perform maintenance on, or in any way modify: The steering system, propulsion system, engine control system, fuel system, environmental control system, or electrical system.

Failure to maintain these systems (listed in the warning above) as designed could violate the laws in your jurisdiction and could expose you and other people to the danger of bodily injury or accidental death. We recommend that you follow the instructions provided in this supplement, the Owner's Manual, the engine owner's manual and the accessory instruction sheets included with your boat.

Hazard Warning Symbols

The hazard warning symbols shown below are used throughout this supplement to call attention to potentially dangerous situations which could lead to either personal injury or product damage. We urge you to read these warnings carefully and follow all safety recommendations.

DANGER

This symbol alerts you to immediate hazards which WILL cause severe personal injury or death if the warning is ignored.

WARNING

This symbol alerts you to hazards or unsafe practices which COULD result in severe personal injury or death if the warning is ignored.

CAUTION

This symbol alerts you to hazards or unsafe practices which COULD result in minor personal injury or cause product or property damage if the warning is ignored.

NOTICE

This symbol calls attention to installation, operation or maintenance information, which is important to proper operation but is not hazard-related.



Fire and/or
Explosion Hazard!



Open Flame
Hazard



Rotating Propeller
Hazard!



Personal Injury/
Falling Hazard

CHAPTER 2: PRODUCT DESCRIPTION

Dimensions and Capacities

Overall Length	Bridge Clearance	Beam	Draft	Fuel Tank Capacity (gal)	Water Tank Capacity (gal)	Holding Tank Capacity (gal)
47' 4"	18' 2"	14' 11"	3' 4"	444	200	48

Layout View

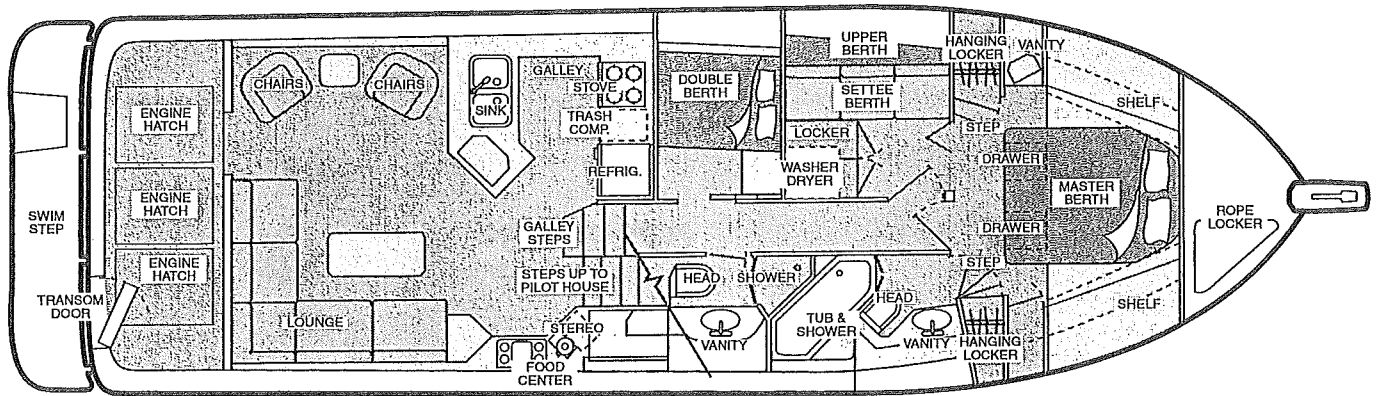

Lifting Sling Positions

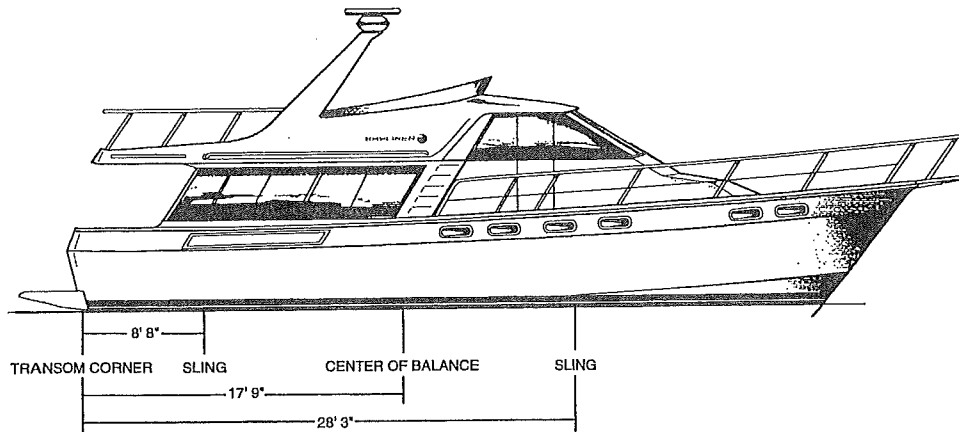

Hull Exterior Hardware

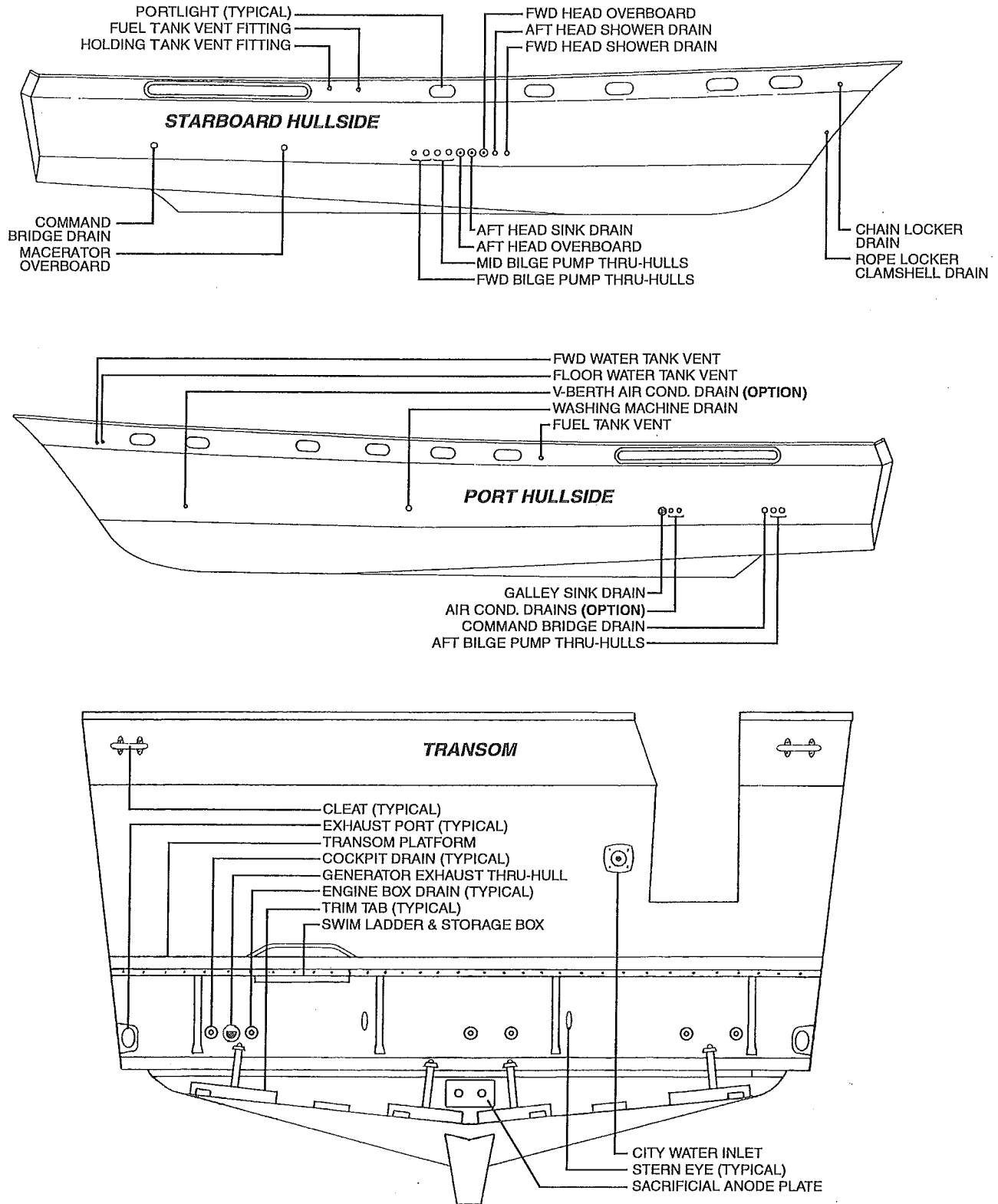

CHAPTER 3: COMPONENTS / SYSTEMS

VHF Radio

The VHF radio has a separate brochure, in your yacht's owner's packet, that explains its operating features. We strongly suggest that you read the operating instructions before using the radio.

Radar

Your Motoryacht is equipped with a marine radar system that will give you complete and accurate 360° radar picture of other vessels, buoys, and landfall surrounding your vessel. To turn this system on, the RADAR switch on the DC breaker panel must be activated. It is recommended that you become familiar with the operating procedures described in the literature supplied with your vessel before operating this system.

Autopilot

The autopilot will aid you in maintaining the chosen heading of your Motoryacht automatically. Before activating the AUTOPILOT switch on the DC breaker panel, refer to the literature supplied with your vessel. It will explain the safe operation methods for this system.

Depth Finder

The depth finder will provide you with measurements of water depth beneath the boat. We suggest that you read the manufacturer's operating instructions included in your yacht's owner's packet before using the unit.

! WARNING

DO NOT use the depth finder as a navigational aid to prevent collision, grounding, boat damage or personal injury. When the boat is moving, submerged objects will not be seen until they are already under the boat. Bottom depths may change too quickly to allow time for the boat operator to react. If you suspect shallow water or submerged objects, operate the boat at very slow speeds.

Compass

Carefully read and follow the compass manufacturer's calibration and operating instructions provided in your yacht's owner's packet.

Trim Tabs

Trim tabs control the longitudinal and lateral trim of your boat at cruising speeds. Two rocker switches identified by the words "BOW DOWN" are located at each helm station.

Once the best bow cruising trim is reached, use the port or starboard trim switches, one at a time, to correct for unequal lateral loading. **DO NOT** use trim tabs to compensate for excessive unequal weight distribution.

Trim tab adjustment should be performed by several short touches to the switch rather than one long one. After each short touch allow about five seconds for the hull to react.

The trim tab hydraulic fluid reservoir is located in the engine compartment. The fluid level should be checked periodically (at least once a year) and refilled as necessary.

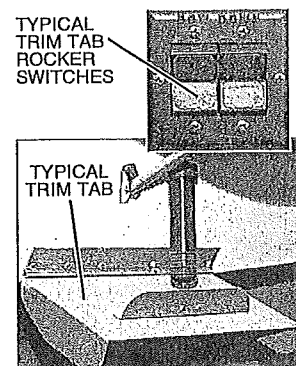

! WARNING

Improper use of trim tabs may cause loss of control. DO NOT use trim tabs in a following sea as they may cause broaching or other unsafe handling characteristics. DO NOT let anyone unfamiliar with trim tabs to operate them.

Anchor Windlass

Please read the manufacturer's instructions in your yacht's owner's packet. To haul the anchor, use engine power (*not* the windlass) to move the boat to, and directly over, the anchor. Activate the windlass to disengage the anchor from the bottom by pulling it straight up. **DO NOT** pull the boat to the anchor using the windlass or continue to operate the windlass if it stalls or is overloaded.

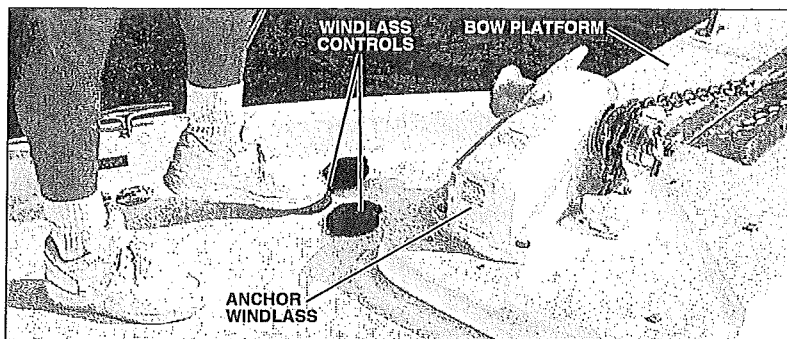

Spotlight

The spotlight has a separate brochure explaining its features. The spotlight can be controlled from either helm station, as long as the dual switch in the pilot house is activated for the station at which you desire control. The spotlight is located on the bow platform.

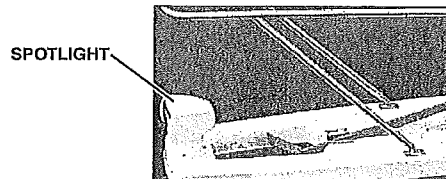

Windshield Wipers

The windshield wiper fluid bottle can be accessed through the port pilot house jump seat.

Davit

See the literature package for complete operating instructions for the davit (winch). The davit control receptacle is located on the bulkhead just forward of the davit.

Inspect the cable often for wear and replace it when frayed. The cable should be kept tight and even on the spool, and under tension when operating the winch.

The cables should be disconnected from the bulkhead-mounted quick-disconnect fittings when the davit is not in use. After removing cables, the load should be secured.

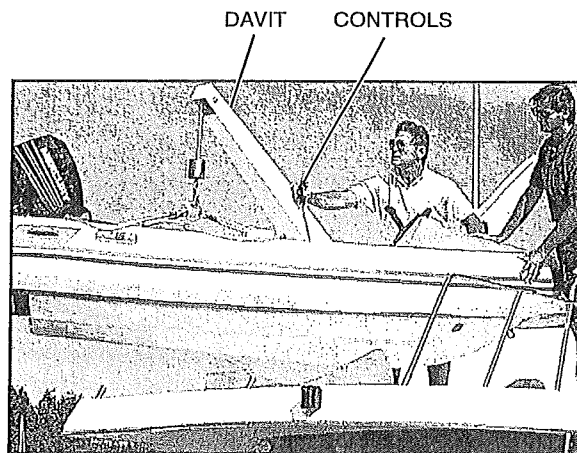
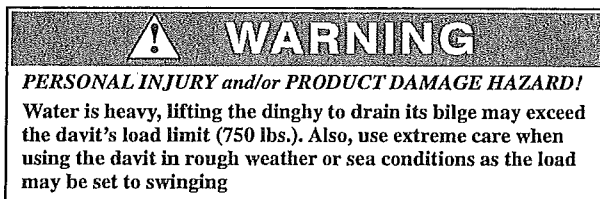
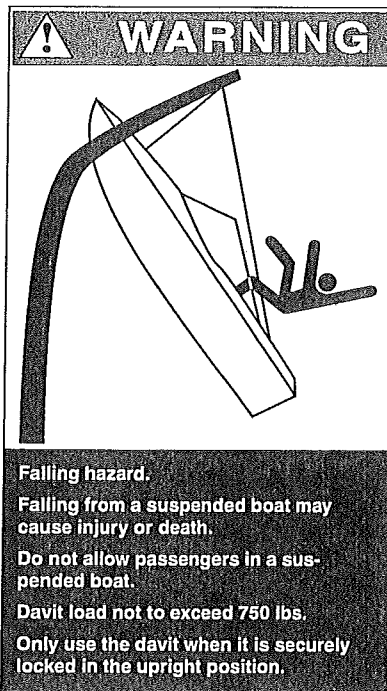

Electrical System

We strongly recommend that you read and understand this section and the Electrical Section of the Owner’s Manual. Wiring diagrams are provided in CHAPTER 4 for use in troubleshooting electrical problems.

⚠ DANGER

 **EXTREME FIRE/EXPLOSION HAZARD!**

- To minimize the risks of fire and explosion, *NEVER* install knife switches or other arcing devices in the fuel compartments.
- *NEVER* substitute automotive parts for marine parts. Electrical, ignition and fuel system parts were designed and manufactured to comply with rules and regulations that minimize risks of fire and explosion.
- *DO NOT* modify the electrical systems or relevant drawings.
- Only qualified personnel should install batteries and/or perform electrical system maintenance.
- Insure that all battery switches are in the OFF position before performing any work in the engine spaces.

⚠ WARNING

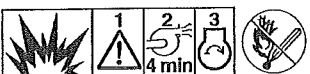
 **FIRE/EXPLOSION HAZARD!**

- Fuel fumes are heavier than air and will collect in the bilge areas where they can be accidentally ignited. Visually and by smell (sniff test), check the engine and fuel compartments for fumes or accumulation of fuel. Operate the bilge blowers for at least four minutes prior to engine starting, electrical system maintenance or activation of electrical devices.
- Minimize the danger of fire and explosion by not exposing batteries to open flame or sparks. It is also important that no one smoke anywhere near the batteries.

⚠ CAUTION

 **SHOCK/ELECTRICAL SYSTEM DAMAGE HAZARD!**

- Never disconnect the battery cables while the engine is running as this can cause damage to your boat’s electrical system components.
- The battery charging systems (alternators and battery charger) on your yacht are designed to charge conventional lead-acid batteries. Before installing gel-cell or other new technology batteries, consult with the battery manufacturer about charging system requirements.

NOTICE

- Electrical connections are prone to corrosion. To reduce corrosion caused electrical problems, keep all electrical connections clean and protect them with a spray-on protectant such as Corrosion Guard®.
- **VOLTAGES** - All boats use either 110-volt AC/60 Hertz, 240-volt AC/60 Hertz or 220-volt AC/50 Hertz single phase systems, and 12-volt DC or 24-volt DC. Electrical distribution panels are labeled with voltage and frequency of AC and DC.

12-Volt DC System

Fuses and Circuit Breakers

The master circuit breakers for accessory power, windlass power and davit power are located next to the battery switches in the aft cabinet on the port side of the salon. Individual component circuit breakers are located on the DC distribution panel in the AC/DC cabinet on the starboard side of the pilot house.



ACCESSORY FUSE
BLOCK (TYPICAL)

An accessory fuse block for electronics, such as the VHF radio, is located at each helm station. Some equipment, such as depth finders and shower pumps may have secondary fuse protection at the unit.

Battery Switches

Rotary switches, located in the aft cabinet on the port side of the salon, are provided for the batteries. A separate switch is provided for each battery. In addition, a parallel switch is provided at each helm to enable you to start the engines using all engine batteries in the event that engine battery power is low.

Batteries

The batteries supply electricity for lights, engine and generator starting, as well as power to turn on accessories. *Periodically remove the battery caps and check the electrolyte level.* If the zinc plates are exposed, add distilled water until they are covered. Corroded battery terminals can be cleaned with baking soda and water. After cleaning the terminals, coat them with a light film of grease. Be sure all battery connections are tight.

Battery condition can be checked on the “Electrical System Monitor” located on the DC distribution panel. The condition of the accessory battery can be read on the starboard engine voltmeter when the accessory battery switch is in the ON position. The starboard voltmeter will register the accessory battery state even when the engines are shut down and the ignition switches are turned off.

Engine Alternators

The engine alternators will maintain proper charge levels in the engine and accessory batteries (some situations may require running engines at 1200 RPM to initiate charging).

Battery Charger

In addition to the engine alternators, your yacht is equipped with a battery charger. We recommend that you thoroughly read and understand the battery charger manual, provided in your yacht’s owner’s packet, before using the charger. The battery charger is located in the engine compartment on the port side. The circuit breaker for the battery charger (located on the main AC power panel) must be ON for charging to occur.



CAUTION

The battery charging systems (alternator and battery charger) installed are designed to charge conventional lead-acid batteries. Before installing gel-cell or other new technology batteries, consult with the battery manufacturer about charging systems requirements.

110-Volt AC System

The AC system can be energized by shore power or the onboard generator. Master circuit breakers, located on the AC panel, provide power source selection. This system is designed so that ship’s power and shore power sources *cannot* supply power simultaneously.



CAUTION

Whether using shore power or the onboard generator, the simultaneous use of several AC components can result in an overloaded circuit. It may be necessary to turn off one or more accessories in order to use another accessory.



 **CAUTION**

WATER HEATER DAMAGE HAZARD! Do not energize the water heater electrical circuit until the heater is **COMPLETELY** filled with water. Even momentary operation in a dry tank will damage the heating elements. Warranty replacements **WILL NOT** be made on elements or tank damaged in this manner.

Shore Power

Shore power receptacles are located outside the pilot house on the starboard side. Shore power receptacles are rated either 30 or 50 amps with appropriate power cords furnished. Since not every shore installation has 30 amp service, we recommend that 15 and 20 amp adapters be purchased. However, whenever 15 or 20 amp adapters are used, there will be a corresponding drop in supplied power from the dockside system.

 **DANGER**

   **FIRE/EXPLOSION/SHOCK HAZARD!**

- To minimize shock and fire hazard, **DO NOT** modify electrical systems or relevant drawings.
- **DO NOT** alter shore power connectors and use only compatible connectors.
- Only qualified personnel should install batteries and/or perform electrical system maintenance.

 **CAUTION**

 **SHOCK/ELECTRICAL SYSTEM DAMAGE HAZARD!**

- Never connect dockside power to your boat outside North America unless you have purchased the International electrical conversion option, which is rated for 220-volt/50 Hertz. North American systems are rated for 110-volt/60 Hertz power.
- Use double insulated or three-wire protected electrical appliances when possible.

NOTICE

When using shore power, the simultaneous operation of several AC accessories can result in an overloaded circuit. It may be necessary to turn off one accessory while operating another.

Before connecting to shore power, ensure all breakers and switches on the AC master panel are in the OFF position. always attach the shore power cord to the boat inlet first; then to the dockside connection to prevent shock or injury from an accidental dropping of the “hot” cord into the water.

 **WARNING**

 **SHOCK/ELECTRICAL SYSTEM DAMAGE HAZARD!**

Monitor the electrical control panel’s polarity indicators when connecting shore power to your boat. A **GREEN** light illuminating after the power cord is plugged into the boat’s external power receptacle indicates acceptable electrical power in which you may energize the main breaker switches. A **RED** light, however, indicates reversed polarity, which could cause electrical system damage and possibly electrical shock injuries. In this case, **DO NOT** energize the main breaker switches. Instead, immediately disconnect the shore power cord (always from the dockside outlet first) and notify marina management.

Check for proper polarity as outlined in the warning above. Each dockside inlet is labeled line 1, line 2 or line 3 which corresponds to the line each operates on the AC master panel. Activate the AC system by turning the main ship/shore transfer switch to the DOCKSIDE position. Then turn on each line master-breaker and individual component breaker as required.

- Voltage on each line can be read by setting the voltmeter selector switch.
- Amperage draw can be read for each line on the line ammeter gauges.
- By using the paralleling switches, lines two and three can be used in conjunction with line 1.

NOTICE

When operating in the parallel mode, the total load is being supplied by line 1 and the amperage draw is monitored only on the line 1 ammeter gauge. Therefore, use caution when operating individual component breakers, so as not to exceed the rating of the line 1 inlet breaker.

Generator Power

Prior to initially operating your generator we strongly urge you to read the manufacturer's operating instructions included in the owner's packet. Polarity has been established in the installation of the generator, therefore the polarity lights will not function in this mode.

Always observe the following:

- Follow instructions in the generator manual for pre-start checks and break-in procedures.
 - The starter switch is located on the AC master panel on the starboard side of pilot house. The generator battery switch is located in the aft cabinet on the port side of the salon.
1. Open the generator seawater intake valve before starting the generator. The seawater intake valve must remain open during generator operation, and the seawater strainer should be checked frequently for leaks and/or debris.
 2. Operate the bilge blowers for a minimum of four minutes before starting the generator. Leave the blowers on while the generator is operating unless the yacht is running at cruising speed.
 3. **Diesel generator;** turn the pre-heat switch to the ON position and allow one minute for pre-heating.
Gas generator; simultaneously press the oil pressure button and turn the starter switch until the generator starts.
 4. Turn the Starter switch to start, releasing it as soon as the generator starts. NEVER operate the starter for more than 30 seconds. If the generator does not start, wait at least 30 seconds before another start attempt is made.
- If your fuel system features a fuel management board (located under the steps next to the galley), fuel to run the generator is supplied from either the port or starboard fuel tanks (see the fuel system diagrams in the next section).

NOTICE

Environmental Hazard - If your boat features a diesel fuel system and a fuel management board; the generator fuel selector valves MUST be set so that return fuel is routed back to the same tank from which it was drawn. Otherwise, generator fuel drawn from a partially full tank and returned to a full tank may spill overboard through the tank venting system.

- If your fuel system does *not* feature a fuel management board, fuel to run the generator is supplied from the starboard fuel tank (see the fuel system diagrams in the next section).
- In addition to servicing the filters attached to the diesel generator, the filter/separator located near the fuel line valves should be serviced as described in the manufacturer's operating manual.
- The coolant mixture installed at the factory consists of equal parts of water and antifreeze (Ethylene Glycol). The coolant bottle is located on the port side of the cockpit (see photo on right). Oil pressure, water temperature, and voltage gauges are provided on, or adjacent to, the AC panel and monitor the engine functions of your generator.

To activate the AC system under generator power; switch the generator master circuit breakers to ON and then turn on each individual component breaker as required.

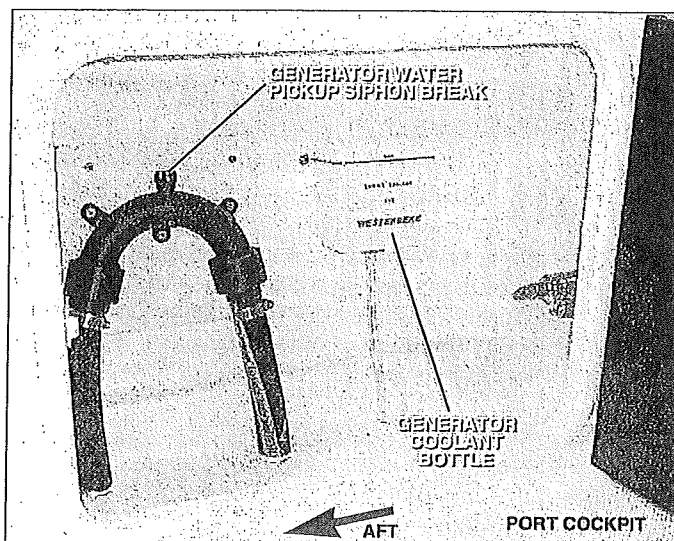

Fuel System

 **WARNING**

 **FIRE/EXPLOSION HAZARD** - It is very important that the fuel system be inspected thoroughly the first time it is filled and at each subsequent filling. The Fueling Instructions in the Owner's Manual and the Fuel Recommendations in the engine operation manual must be followed.

 **CAUTION**

Air in the diesel supply system can stop an engine or severely restrict performance. If you suspect air in your diesel fuel lines, refer to your engine operation manual for detailed instructions on how to "bleed" the system.

 **CAUTION**

Avoid the storage or handling of gear near the fuel lines, fittings and tank.

Carefully read the Fuel Section of the engine operation manual included in your yacht's owner's packet. Give special attention to the subject of Fuel Recommendations. Filters/separators should be inspected periodically for debris and replaced as needed according to the instructions detailed in your engine manual, generator manual and in the filter literature supplied in your yacht's owner's packet.

Fuel Fills and Vents

Fuel fills are located on the side decks just aft of the bow rail. Fuel receptacle caps are marked "Diesel" or "GAS". Fuel vents are normally located in the hull or transom below and in the same general area as the fill. If you experience difficulty filling the fuel tank, check to see that the fuel fill and vent lines are free of obstructions and kinks.

Anti-siphon Valve (Only Gas Engine Fuel Systems)

An anti-siphon valve is an integral part of the fuel line barb fitting on each fuel tank. These valves are spring loaded and are opened by fuel pump vacuum. If a fuel line ruptures the valve prevents the siphoning of fuel from the tank.

 **WARNING**

 **FIRE/EXPLOSION HAZARD** - If an engine problem is caused by fuel starvation, check the anti-siphon valve. If the valve is stuck or clogged, shut down the engine and replace it. Except in a crisis, NEVER operate the engines without the anti-siphon valve.

Fuel Management Board

Your yacht may or may not be equipped with a fuel management board.

- On models equipped with a fuel management board, fuel can be directed from either tank to the engines and generator using the supply valves. The fuel management board is located under the steps next to the galley.
- On models that are *not* equipped with a fuel management board, the port fuel tank provides fuel for the port engine while the starboard fuel tank provides fuel for the starboard engine *and* the generator.

Fuel Transfer Pump (Diesel Only)

Yachts without a fuel management board will be equipped with a fuel transfer pump. The fuel transfer pump is used to transfer fuel from a full tank to a nearly empty tank. The pump is activated by the using the fuel transfer switch, located at the pilothouse helm station.

 **CAUTION**

Environmental Hazard! NEVER transfer fuel into a full (or nearly full) fuel tank. Fuel transferred into a full tank may spill overboard through the tank venting system.

Fuel Quality

Make sure your fuel suppliers are reputable and can be relied upon to furnish clean, high quality fuel. Once you have found such suppliers, keep your tank as full as possible with their fuel, allowing for expansion due to temperature variations. Then, if you are forced to add to the tank with a potentially poor quality supply, the portion of poor quality fuel will be minimized.

Fuel System Diagrams

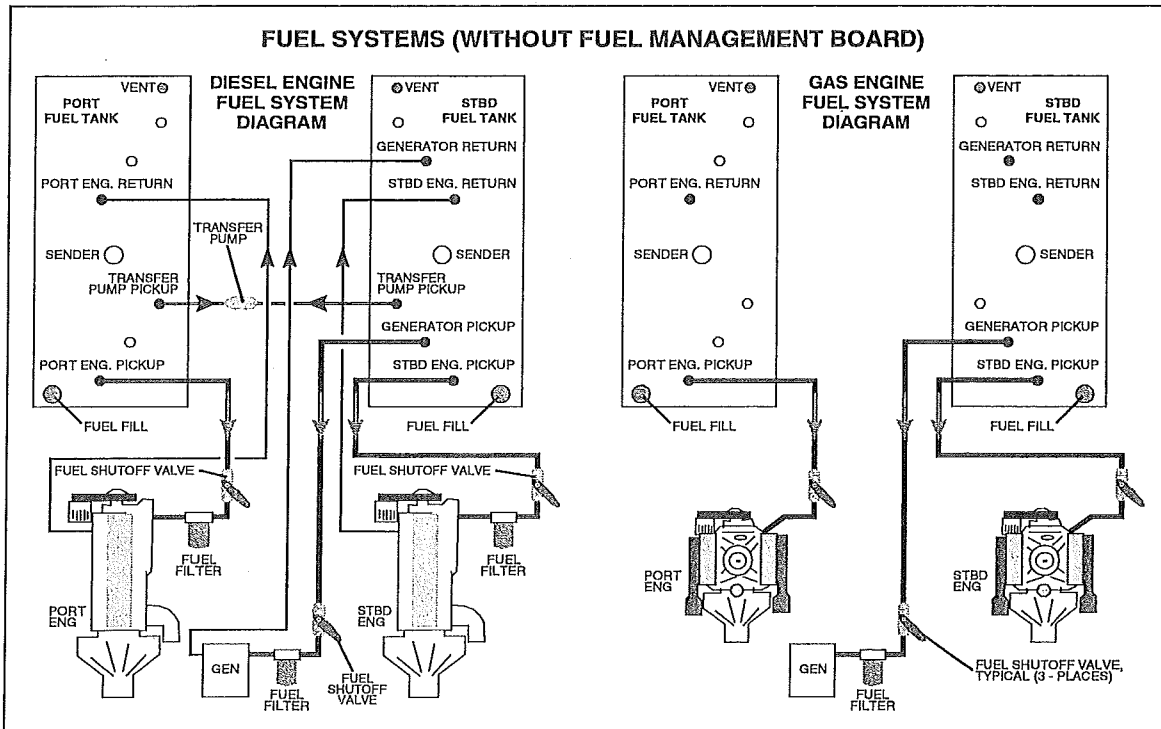
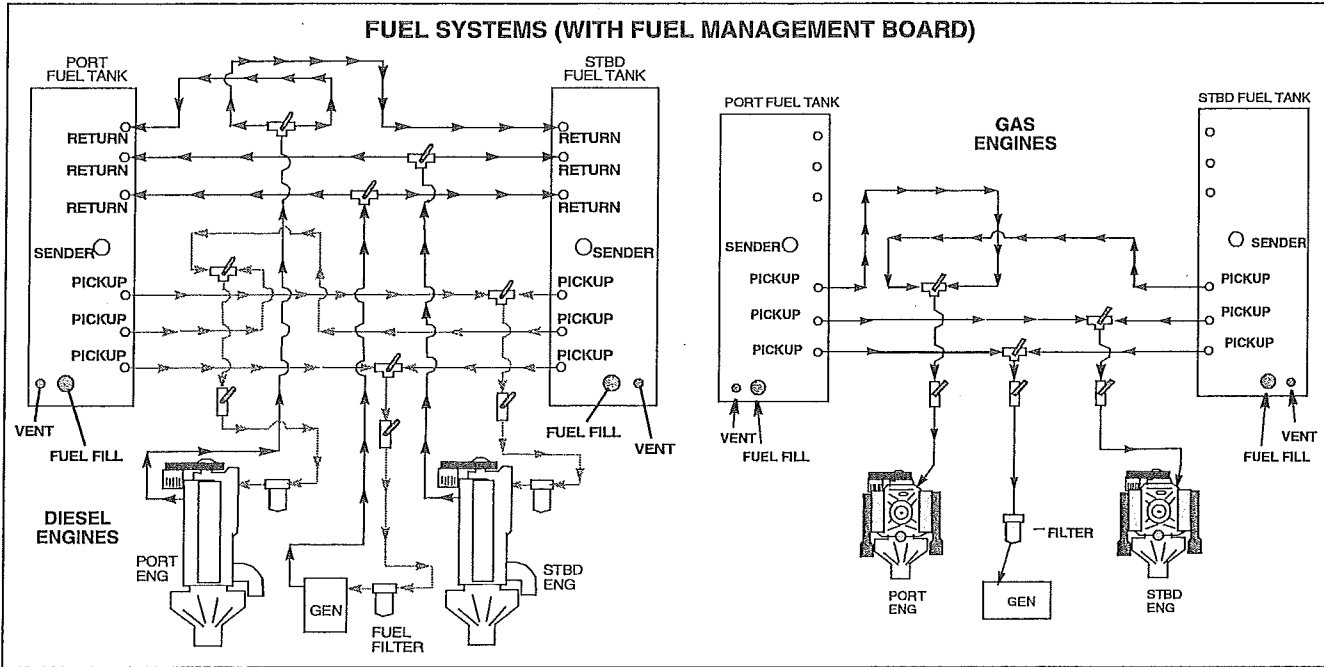

Engine Room Ventilation System

The bilge blowers remove fumes from the engine compartment and draw fresh air into the compartment through the deck vents. To ensure fresh air circulation, operate the bilge blowers for at least four minutes before starting the engines or generator, during starting, and while operating the yacht below cruising speed.

⚠ WARNING

Operation of the blower system is **NOT A GUARANTEE** that explosive fumes have been removed. If you smell any fuel, **DO NOT** start the engine. If the engine is already running, immediately shut off the engine and all electrical accessories. Investigate immediately. **DO NOT** obstruct or modify the ventilation system.

Water Pickup Systems

The seawater strainers should be checked regularly for debris. The standard layout is one strainer for each engine, one for the generator and one for the air conditioning system (option). The strainers are located in the engine room.

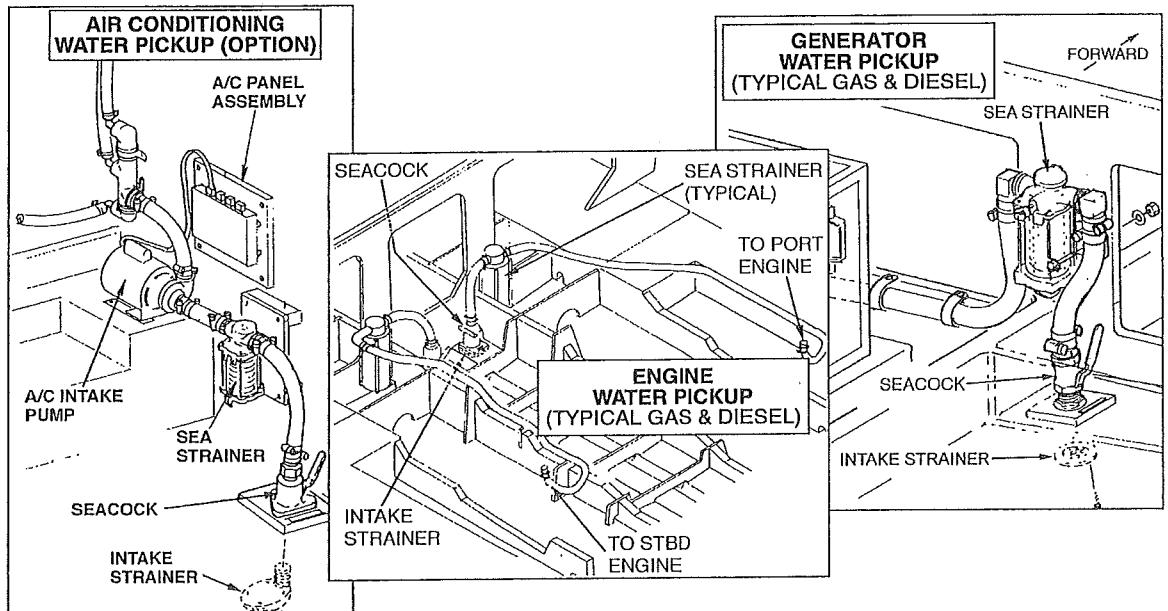

Exhaust Systems

The exhaust system is designed to keep water out of the engines in most sea conditions. However, **DO NOT** anchor stern to sea, and **DO NOT** shut off the engines if the seas are too high. Always use good seamanship and consider the sea conditions *before* anchoring or shutting off the engines.

Check all of the exhaust system clamps after the first 20 hours. Continue to check the clamps periodically after that.

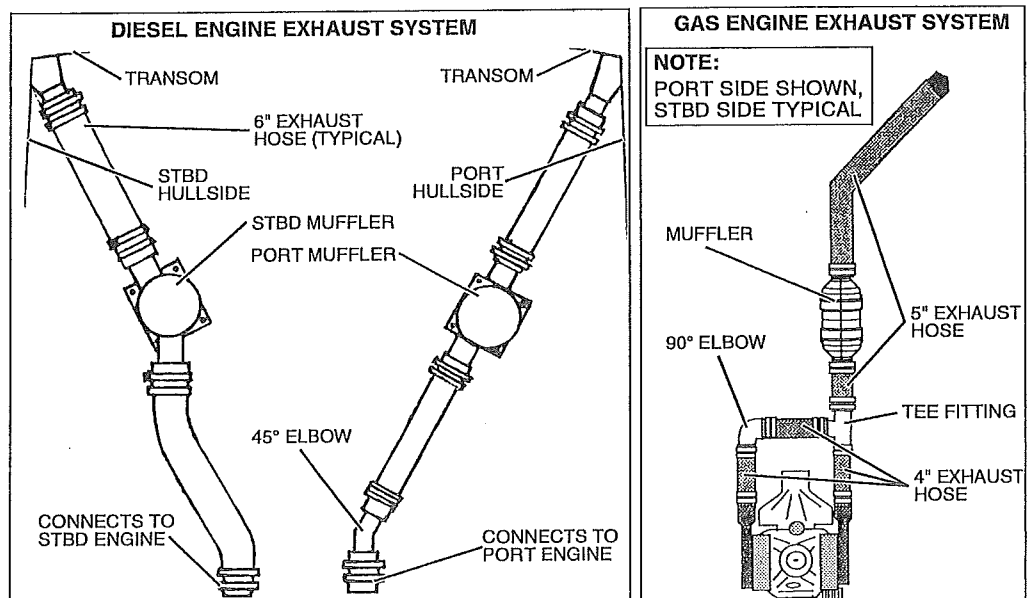

Shaft-Transmission Alignment

- Alignment between the engine transmission output shaft and the propeller shaft is critical. This alignment has been performed at the factory, and was rechecked by the dealer after the boat had been in the water for 48 hours.
- An alignment inspection should be performed as part of the routine maintenance program (after the initial 30 hours of operation, then every 60 hours) and whenever unusual noise or vibration is noticed.
- To insure proper alignment after a hallout or dry storage, wait 48 hours after launching before making final alignment adjustments.

Checking Alignment

Engine alignment requires moving the engine and should be performed by a marine mechanic. However, *checking* the alignment is relatively simple when these steps are followed:

1. Remove the flange bolts at the transmission-to-prop shaft coupling and slide the shaft aft until the flanges are about 1/4" apart.
2. Rotate the shaft to see if there is obvious "wobble" of the shaft flange. If there is, it may indicate shaft damage and should be inspected by a marine mechanic as soon as possible.
3. Move the shaft up and down and from side to side to determine, as closely as possible, the central position where the shaft is normally located. At this position, the transmission flange should align with the shaft flange without moving the shaft more than 1/8". If this is not the case, *a misalignment condition exists* (see CAUTION on right).
4. Move the shaft flange into contact with the transmission flange.
5. Check the gap between flange faces by trying to insert a 0.003" feeler gauge at the top, bottom and each side.
6. Repeat this operation after rotating the shaft flange 1/4 turn (3 times). If the feeler gauge can be easily inserted at any point, *a misalignment condition exists* (see CAUTION on right).
7. Reinstall the flange bolts, nuts and lock washers (if provided) and torque to the specifications listed to the right. Replacement bolts, nuts and washers *must* be corrosion resistant and grade 8 or better.

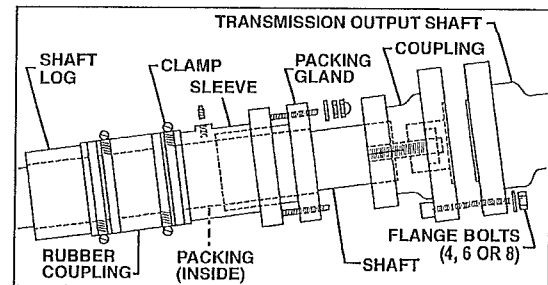

CAUTION

If misaligned, a qualified mechanic MUST perform an alignment as soon as possible. Continued use may lead to premature engine, transmission, shaft, shaft seal and/or hull damage.

BOLT SIZE	TORQUE
3/8" - 24	- 40 lbs. (+/- 7 lbs.)
7/16" - 20	- 65 lbs. (+/- 10 lbs.)
1/2" - 20	- 95 lbs. (+/- 15 lbs.)
5/8" - 18	- 200 lbs. (+/- 30 lbs.)
M16 x 1.5	- 175 lbs. (+/- 25 lbs.)

Shaft Log Stuffing Box Packing

The propeller shaft emerges from the bottom of the yacht through an opening called the shaft log. The shaft stuffing box is connected to the shaft log by a short length of special flexible hose. Packing rings are compressed around the shaft by the packing gland. The stuffing for the box prevents excessive amounts of water from leaking around the shaft and into the boat. Normal wear can cause stuffing box leakage to increase. Excessive leakage can usually be stopped by tightening the packing gland nuts slightly. **DO NOT** over tighten the packing gland nuts. A slight leak (up to 10 drops per minute while running) is normal and helps lubricate the packing and is therefore **NECESSARY**.

When stuffing box leakage becomes excessive, even after following the above steps, packing replacement can be performed as follows;

1. Remove the yacht from water.
2. Loosen the packing gland nuts and back the packing gland from the sleeve. Remove the old packing.
3. Wrap new packing around the shaft (4 rings, 3/16" for 1 1/2" shafts), then cut the rings with a razor blade at an angle approximately 30 degrees to the long axis of the shaft. Stagger the ends of each ring around the shaft and insure that the ring are at the bottom in the sleeve.
4. Tighten the packing gland nuts until resistance is felt.

When initially launched, the packing must be allowed to leak at a rate of 5 to 30 drops per minute, as it will expand and seal from water contact and friction heat from the turning shaft. Failure to allow this leak-off will result in packing burnout after a short period of time.

Steering System

Your yacht's steering system is manual hydraulic, not power steering. At no time should you expect this system to turn as easily as a car's power steering.

A rhythmic pulsing when turning the wheel is a characteristic of the pump and is not a malfunction. Also, when coming off a hard-over position, resistances may be felt, followed by a distinct sound. This is a normal situation resulting from the release of the check valve.

The fluid reservoir for the hydraulic steering system is located in the aft end of the engine compartment. Follow instructions in your yacht's owner's packet and on the reservoir. Check the fluid level and pressure regularity.

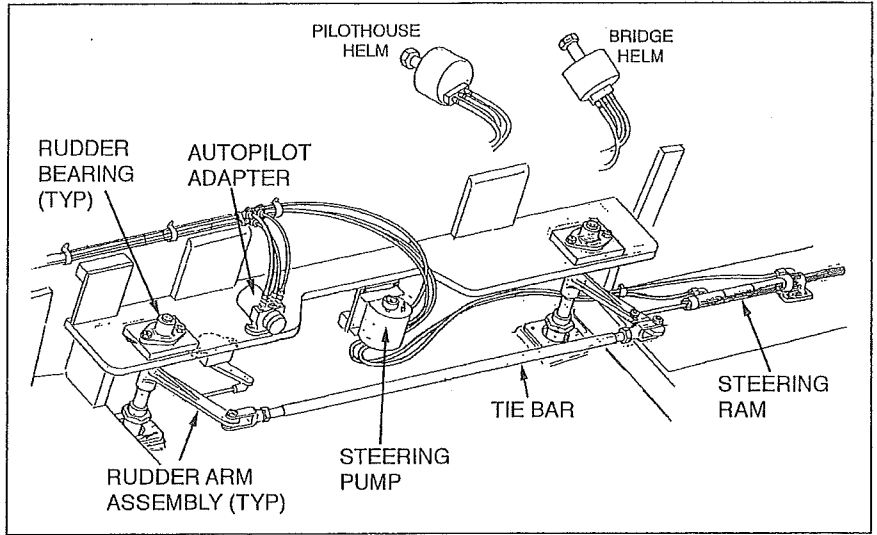

Rudder Stuffing Gland

The rudder stuffing gland is part of the assembly where the rudders emerge from the bottom of the boat. It is very similar to the propeller shaft stuffing box and will require the same maintenance. Since it does not receive the same wear as the propeller shaft, repacking is seldom required. This shaft stuffing gland should not leak any water.

Fresh Water System

The water filter, located in the utility room (access through the galley steps) should be inspected and cleaned often.

When connected to a dockside water supply, the DC power switch for the water pump should be turned OFF.

The water tank is equipped with a water level indicator in the AC/DC cabinet on the starboard side of the salon. It is always a good idea to top off the water tank at every opportunity to avoid the possibility of running short of fresh water.

A pressure accumulator tank is installed in the system. The pressure accumulator tank assists the pressure pump by reducing ON/OFF cycling and a more even flow of water.

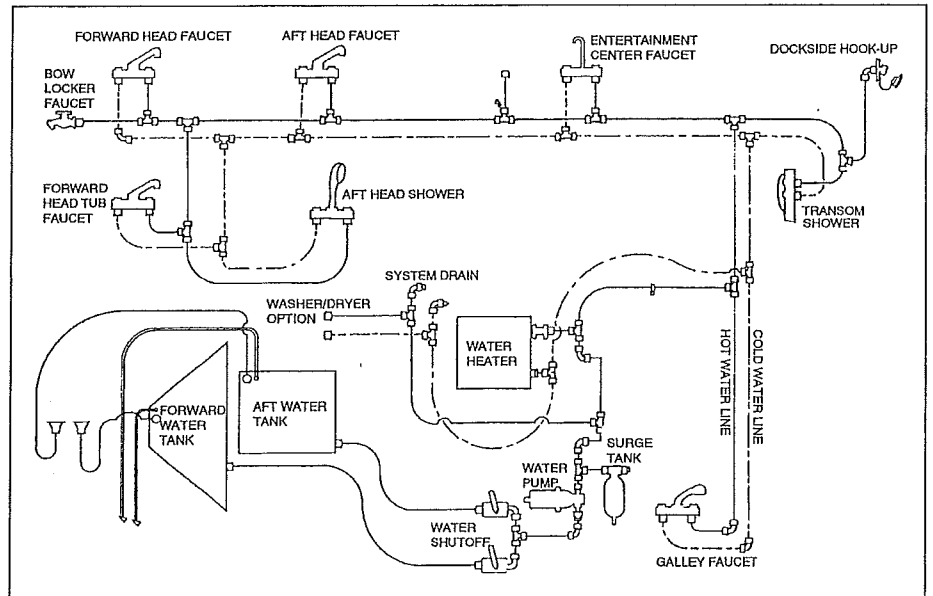

The water fill fittings are located on the port side of the forward deck. When your boat is to be left unattended for long periods of time, pump the water tank dry to prevent stored water from becoming stagnant and distasteful. Should it become necessary to disinfect the fresh water system, ask your dealer about treatment systems available and follow the manufacturer's instructions.

Water Heater

⚠ WARNING

SCALDING HAZARD! Water heated by the heat exchanger system can reach temperatures high enough to scald the skin. Use care when using hot water after running the port engine for any period of time.

COMPONENT DAMAGE HAZARD! Water heaters must be kept full of water to avoid damage to the 110-volt heating elements. They should also be drained (power turned OFF) when the possibility of freezing exists.

Please read the manufacturer's instructions supplied in your yacht's owner's packet. The water heater is connected to the AC power system. The water heater is located on the port side of the utility room. Access is gained through the galley steps.

Drain System

Sinks and showers ("gray water") drain overboard. Sinks above the waterline have gravity drains while the aft head sink and both showers are pump-drained. The drain sump pumps are located behind the sliding door on the starboard side at the forward end of the passageway.

Washdown Systems

The outlet for the freshwater washdown system is located on the starboard side of the cockpit. The outlets for the raw water washdown system (seawater) are located on the port side of the cockpit and the starboard side of the forward deck. Make sure the seacock is open before turning the raw water washdown system on.

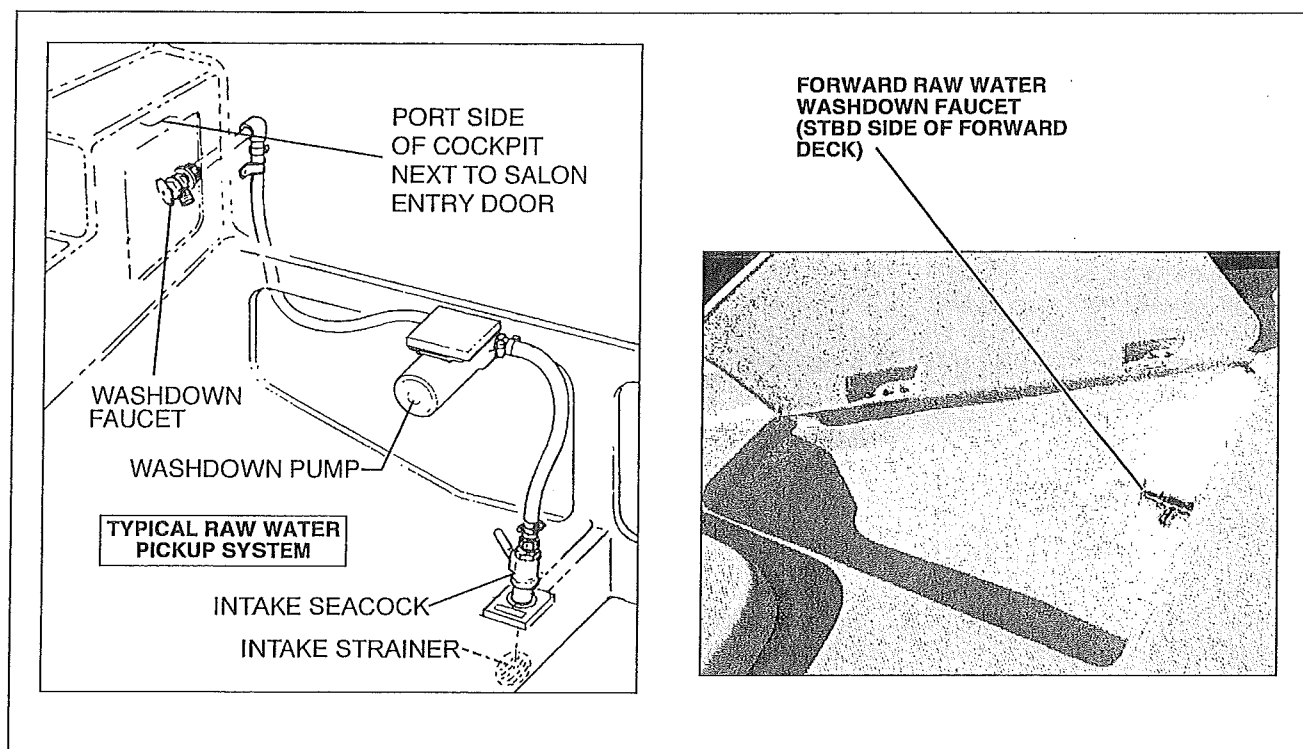

Bilge Pump System

Your yacht is equipped with six impeller-type bilge pumps. The bilge pumps are controlled by automatic bilge pump switches (autofloat switches) and/or switches on the dash panel.

The autofloat switches activate whenever water accumulates above a preset level in the bilge. They are wired directly to the battery and will normally function even when the yacht is completely shut down and unattended, such as when the yacht is moored at a marina.

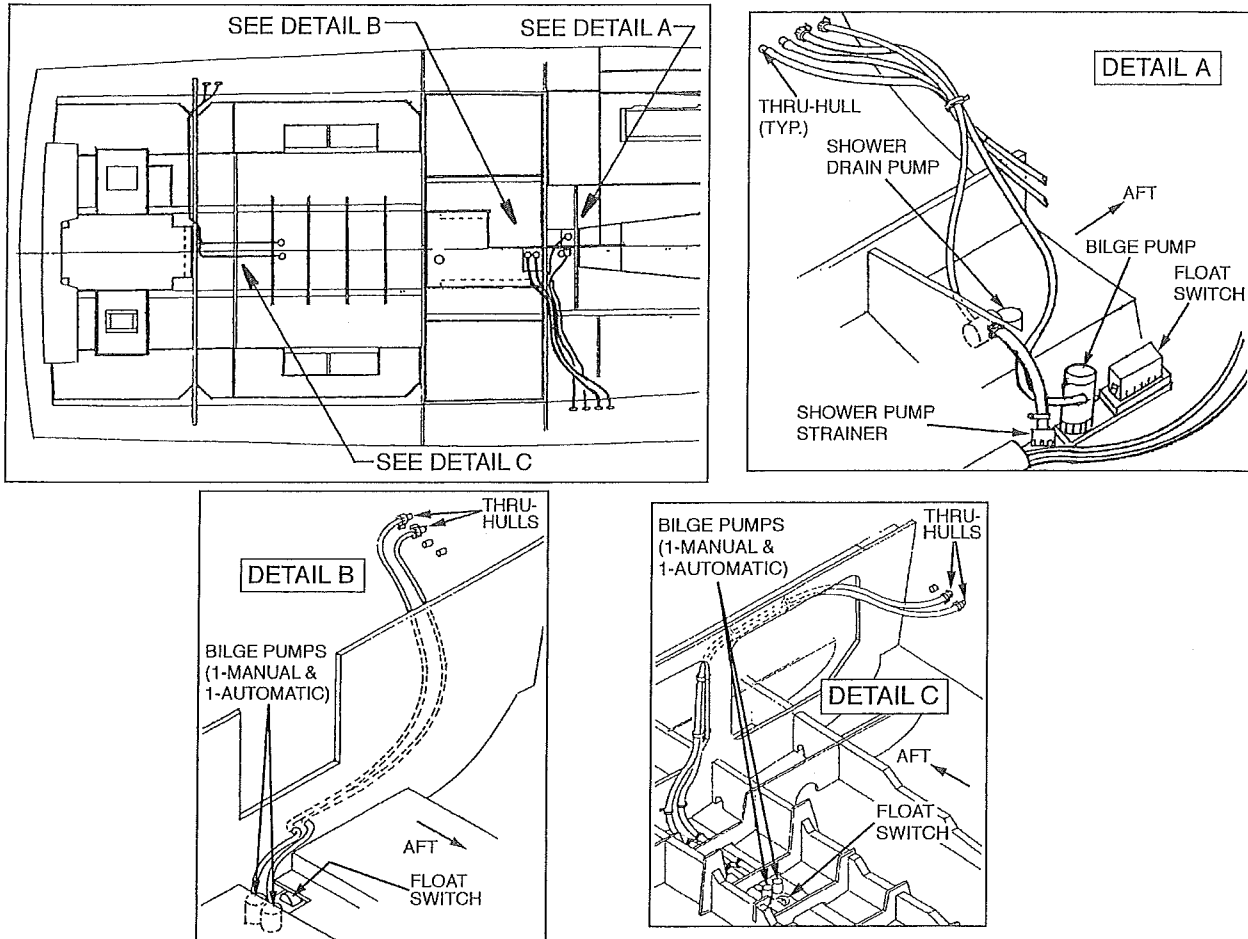

Bilge Pump Maintenance

Bilge pumps should be checked often to verify that they are working properly. Check each bilge pump by activating its dash-mounted switch. Verify that water in the bilge is pumped overboard. If bilge water is present and the pump motor is running but not pumping, inspect the discharge hose for a kink or collapsed area. If no problems are found, check the bilge pump housing for clogging debris as follows:

To remove the power cartridge:

1. Lift the tab while rotating the fins counter-clockwise and lift out the power cartridge (Fig. 1).
2. Clear the housing of debris.

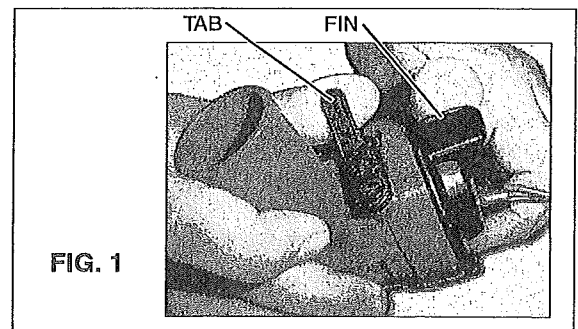

To reinstall the power cartridge:

1. Make sure the "O" ring is properly seated and coat the "O" ring with a light film of vegetable oil or mineral oil (Fig. 2).
2. Align the two cams on either side of the power cartridge with the two slots on the outer housing. Press the power cartridge into the housing and twist clockwise. Ensure proper reinstallation by attempting to twist the fins counter-clockwise without lifting the tab. The cartridge should stay in place.

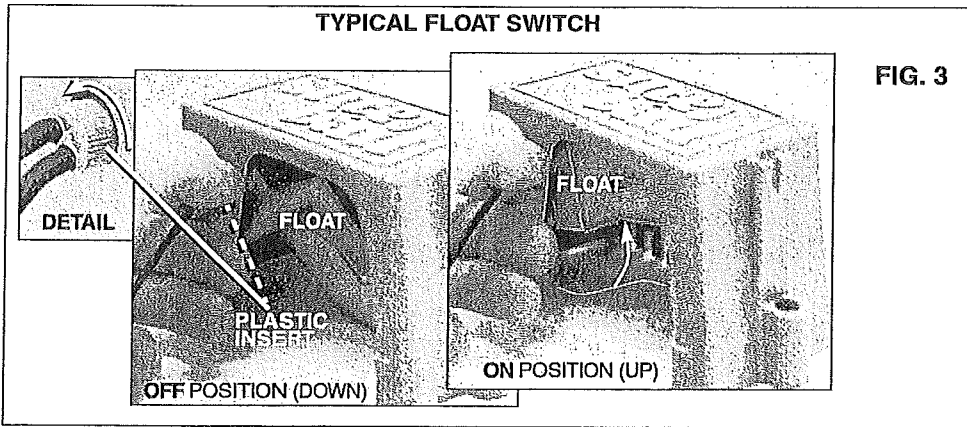
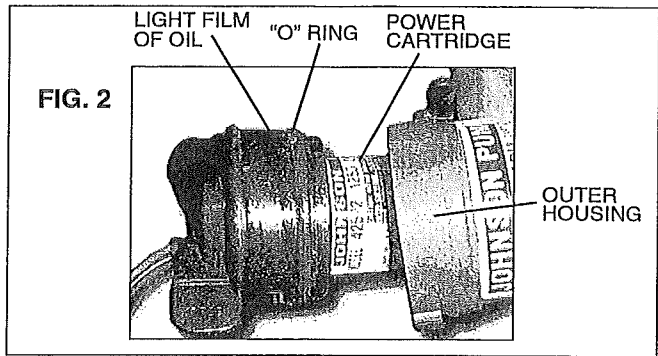

FIG. 3

If applicable, the autofloat switch should also be checked often for proper operation. Lift the float by turning the plastic insert where the wires enter the housing, 1/4 turn counter-clockwise (Fig. 3).

As the float is lifted, the bilge pump should turn on. If lifting the float does not turn the pump on, check the inline fuse. If the fuse is good but the switch does not work, it may indicate a bad switch or possibly a low battery.

NOTICE

Discharge of oil, oil waste or fuel into navigable waters is prohibited by law. Violators are subject to legal action by the local authorities.

Marine Head System

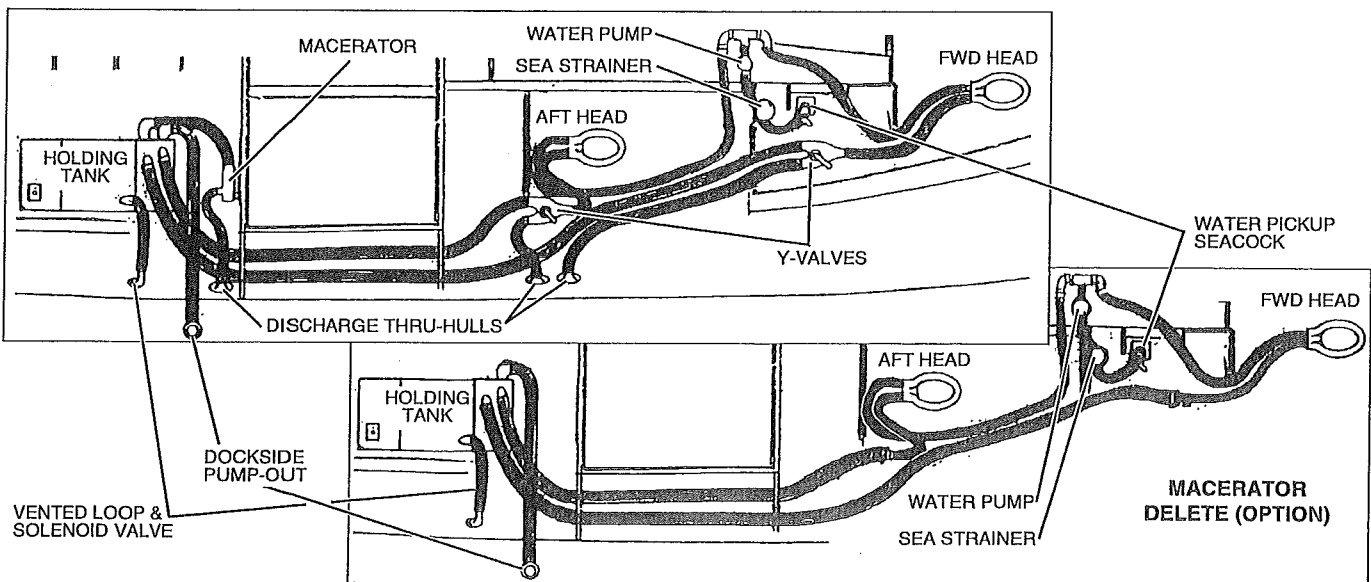

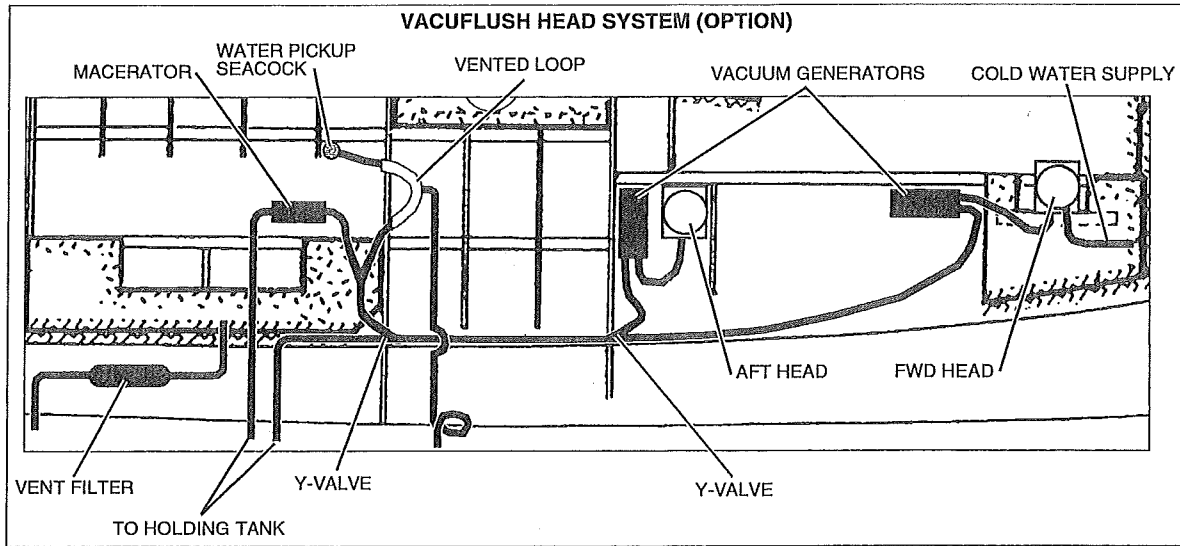

The marine head system is designed so that waste from either head may be flushed into the holding tank or overboard (where regulations permit). Routing is decided by the setting of the head “Y” valve. Access to the forward head “Y” valve is on the starboard side of the hallway in the vacuum cabinet at floor level. Access to the aft head “Y” valve is through the small door on the starboard bulkhead next to the galley steps.

The holding tank can be emptied by dockside pump-out or, where permitted, by actuating the macerator pump (with the discharge seacock open) from the pilothouse DC panel. The holding tank is located in the engine room, outboard of the starboard engine.

The holding tank on your motoryacht has a level indicator. Even so, it is advisable to empty the tank at every opportunity to reduce the possibility of problems which might be caused by an indicator error. The dockside discharge fitting is located about four feet aft of the fuel fill fitting on the starboard deck trail.

Check the local regulations regarding the legal use of marine head systems in your area.

Air Conditioning/Heating (Optional)

Your yacht may be equipped with an optional air conditioning system. Both heating and cooling are controlled from the same panel. Please refer to the manufacturer’s operating instructions included in your yacht’s owner’s packet.

110-Volt AC/12-Volt DC Refrigerator

Your yacht features 110-volt AC/12-volt DC refrigerators. Please read the manufacturer’s instructions supplied in your yacht’s owner’s packet. The refrigerators operate on 12-volt DC power unless 110-volt AC power is being supplied by the generator or shore power *and* the AC refrigerator breaker is ON.

NOTICE

In less than 24 hours, the refrigerators can render a 100-amp battery useless for engine starting. When operating on 12-volts, it is advised that the cold settings not be set higher than two (2). It is also advisable to turn off your refrigerators at night or when not in use. If you are going out for more than a day and cannot connect to dockside power, plan to run the engines or generator each day to maintain a charged battery.

Ice Maker

Make sure that the breaker switch located on the AC master panel is ON before attempting to use the ice maker. Detailed instructions can be found in the literature package.

Blender

Make sure that the breaker switch located on the AC master panel is ON before attempting to use the blender. Detailed instructions can be found in the literature package.

Range/Oven

Operating instructions are included in your yacht's owner's packet. Before attempting to operate the range/oven, make sure the breaker switch on the AC master panel is ON.

Microwave Oven

Before attempting to operate the microwave oven, make sure the breaker switch on the AC master panel is ON. Operating instructions for the microwave oven can be found in your yacht's owner's packet.

Trash Compactor

Make sure that the breaker switch located on the AC master panel is ON before attempting to use the trash compactor. Detailed instructions can be found in the literature package.

Washer/Dryer (Optional)

Access to the washer/dryer is on the port side of the hallway, forward of the aft stateroom. Before attempting to operate the washer/dryer, make sure that the breaker switch, located on the AC master panel, is ON. Further operating instructions are included in the literature package. Access to the lint trap is through the outboard cabinet door of the hanging locker in the mid stateroom.

DRYER LINT TRAP
AND VENT ACCESS

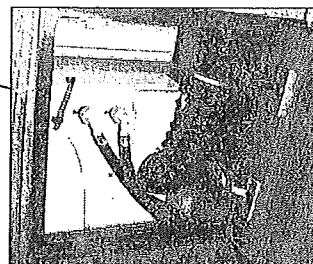

Vacuum System

Operating instructions are included in your yacht's owner's packet. Before attempting to operate the vacuum system, make sure the breaker switch on the AC master panel is ON. The vacuum hose inlet receptacle is located behind the aft sliding door of the cabinet on the starboard side of the hallway.

SLIDING
CABINET
DOOR

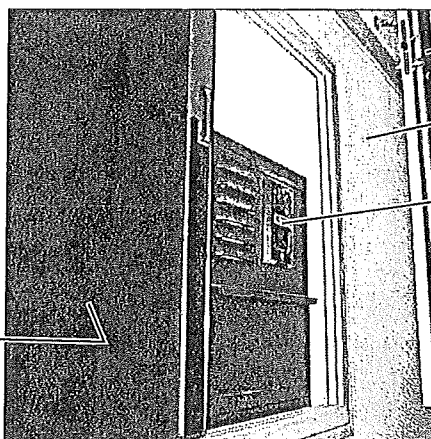

AFT HEAD DOOR

STARBOARD
HALLWAY
BULKHEAD

VACUUM HOSE
INLET RECEPTACLE

Audio/Video Equipment

The standard and optional audio/video equipment on your yacht have separate brochures explaining their operating features. Note that AM radio reception may be impaired anytime the engine is running.

CHAPTER 4: WIRING DIAGRAMS

Standard Dual Dockside

- NOTES:**
- (1) CONTINUES TO OR FROM ANOTHER PAGE.
 - (2) EXPORT OPTION ONLY.
 - (3) OPTIONAL EQUIPMENT.
 - (4) NEUTRAL CONDUCTORS FROM ALL LINE 1 APPLIANCES CONNECT TO LINE 1 NEUTRAL BUSS.
 - (5) NEUTRAL CONDUCTORS FROM ALL LINE 2 APPLIANCES CONNECT TO LINE 2 NEUTRAL BUSS.
 - (6) NEUTRAL CONDUCTORS FROM ALL LINE 3 APPLIANCES CONNECT TO LINE 3 NEUTRAL BUSS.
 - (7) GREEN GROUNDING CONDUCTORS FROM ALL APPLIANCES CONNECT TO AC GROUND BUSS.
 - (8) INDIVIDUAL LINE MASTER BREAKER SIZES:
 - (9) INLETS:
 - 110 VOLT 30 AMP DOMESTIC
 - 110 VOLT 30 AMP EXPORT
 - 220 VOLT 16 AMP EXPORT
 - 110 HEAVY DUTY - 50A
 - 220 STANDARD - 15A
 - 220 HEAVY DUTY - 30A - (10) MASTER BREAKER SLIDER LOCKOUTS PREVENT CIRCUITS FROM BEING ENERGIZED BY SHORE POWER AND GENERATOR POWER SIMULTANEOUSLY.

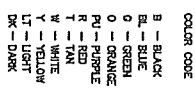

- COLOR CODE**
- B - BLACK
 - BL - BLUE
 - 0 - GREEN
 - G - GREEN
 - OR - ORANGE
 - PU - PURPLE
 - P - PINK
 - T - TAN
 - W - WHITE
 - Y - YELLOW
 - LT - LIGHT
 - DK - DARK

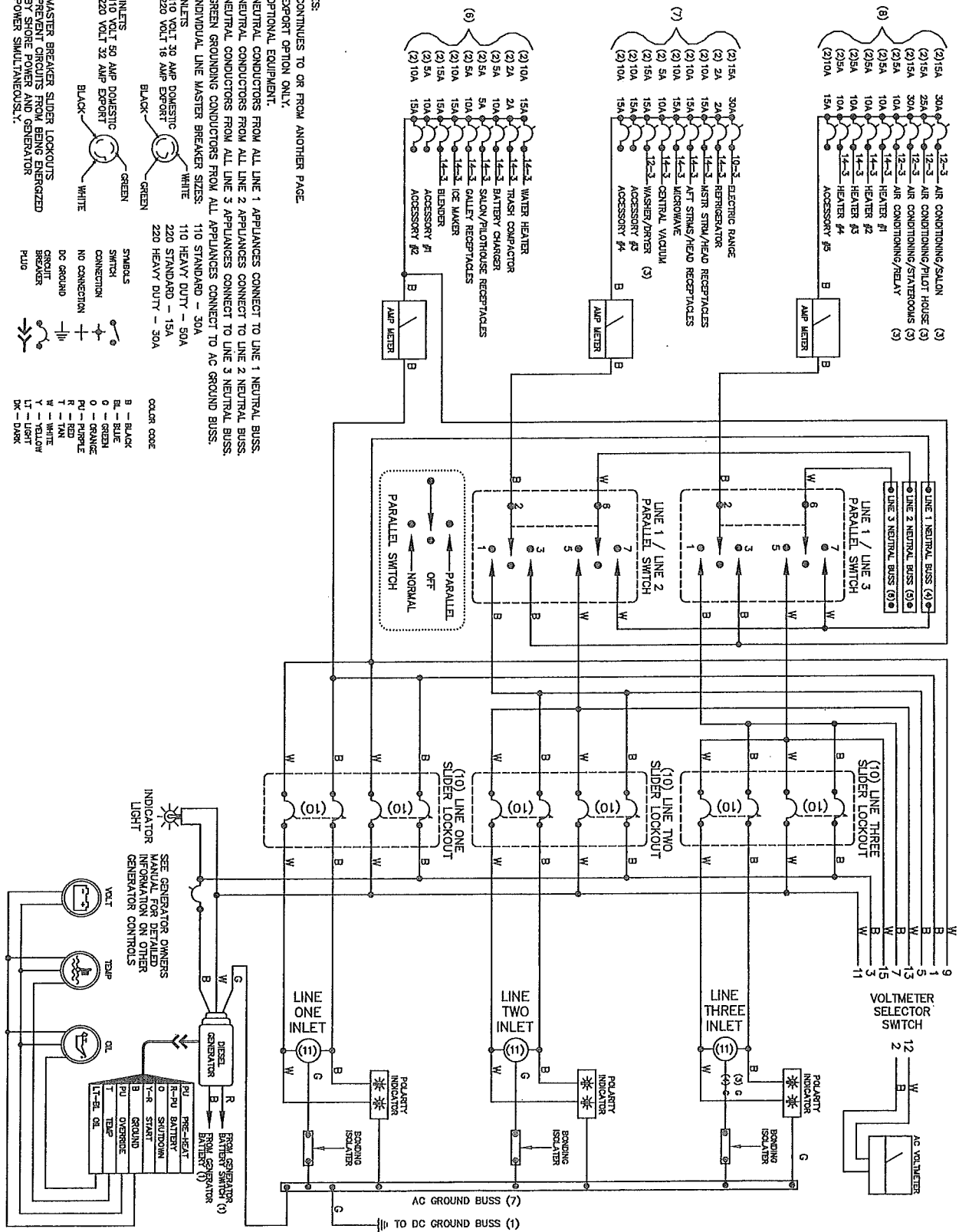

Gas Engine Electrical System

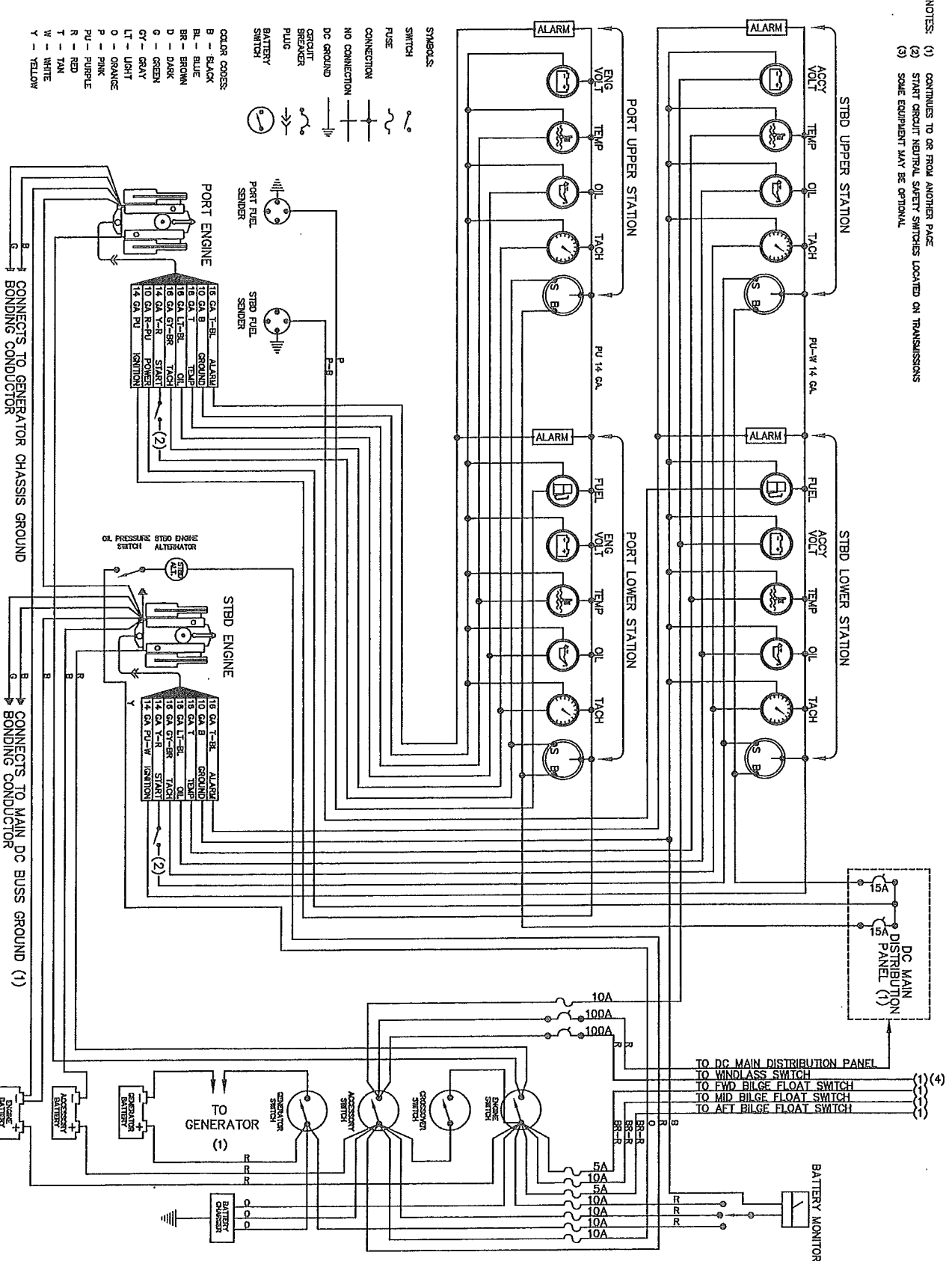

Diesel Engine Electrical System

- COLOR CODES:**
 B - BLACK
 BL - BLUE
 BR - BROWN
 D - DARK
 G - GREEN
 GR - GRAY
 LT - LIGHT
 O - ORANGE
 P - PINK
 PU - PURPLE
 R - RED
 T - TAN
 W - WHITE
 Y - YELLOW

- SYMBOLS:**
 SWITCH
 FUSE
 CONNECTION
 NO CONNECTION
 DC GROUND
 CIRCUIT BREAKER
 FLUG
 BATTERY SWITCH

- NOTES:**
 (1) CONTINUES TO OR FROM ANOTHER PAGE
 (2) PRE-HEAT SWITCHES AT LOWER STATION ONLY
 (3) START CIRCUIT NEUTRAL SAFETY SWITCHES LOCATED ON TRANSMISSIONS

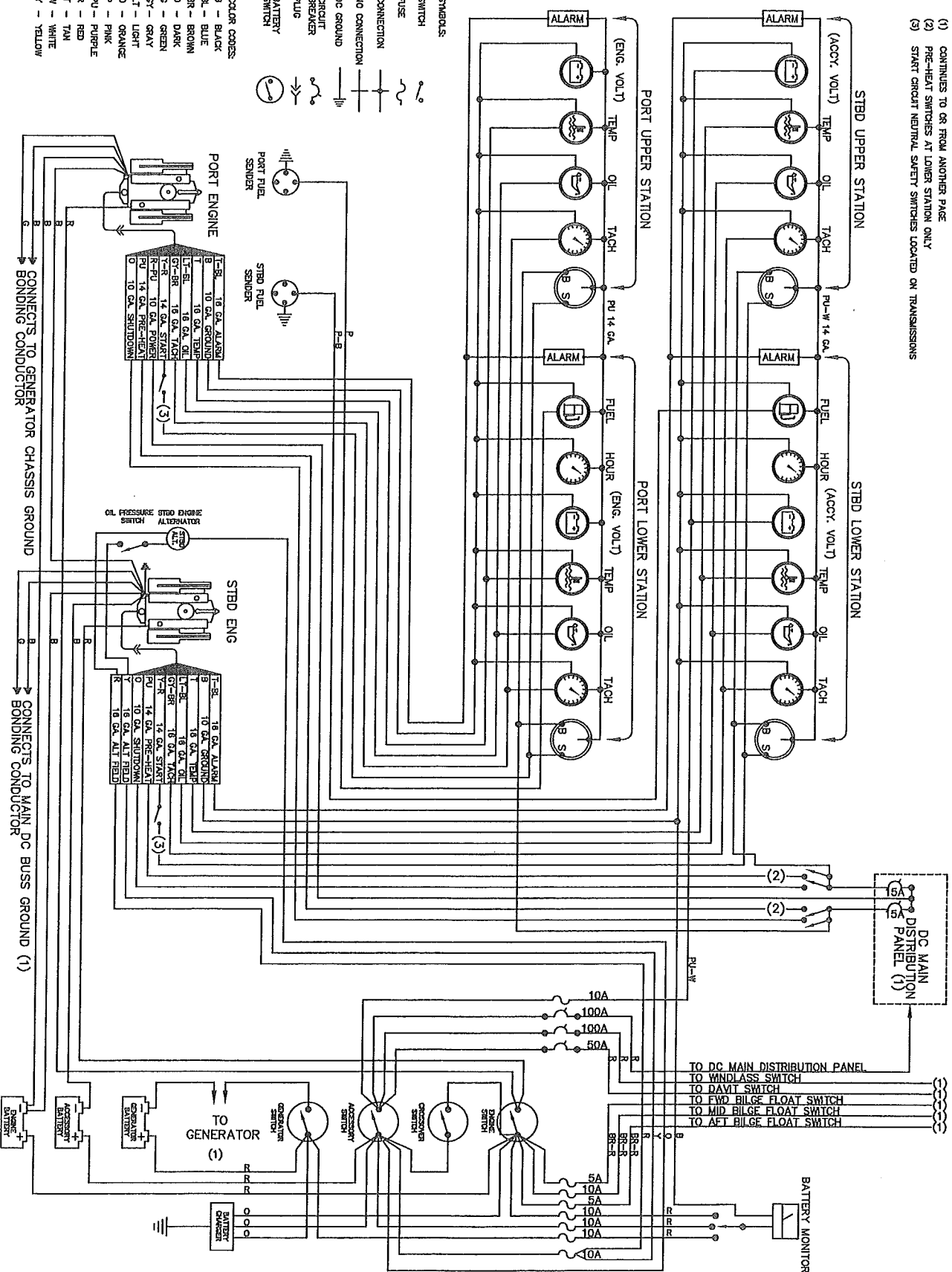

CHAPTER 5: ISO SYMBOLS

These ISO symbols may be used throughout your boat, the Owner's Manual and this Owner's Manual Supplement to identify and describe various systems and components.

Definitions

Symbol	Description	Symbol	Description	Symbol	Description
	Air Cooled Charge Air Cooler		Air, General		Air, Intake (For Combustion)
	Anchor		Blower		Compass
	Counter Clockwise Rotation		Crankshaft Power		Disengage
	Elapsed Time		Electric Generator		Electrical Preheat for Diesel Engine
	Engage		Engine		Engine Air Intake
	Engine Coolant		Engine Exhaust Gas		Engine Exhaust Gas Pressure
	Engine Exhaust Gas Temperature		Engine Inlet Air Filter		Engine Inlet Air Pressure
	Engine Inlet Air Temperature		Engine Oil		Engine Oil Filter
	Engine Oil Level		Engine Oil Pressure		Engine Oil Temperature
	Engine Rotation Speed, R/MIN		Engine Start		Engine Water Jacket Drain
	Exhaust Gas		Filter		Fresh Water
	Fresh Water Cooled Charged Air		Fresh Water Tank		Fuel, Diesel
	Fuel Filter		Fuel General		Fuel Level
	Fuel, Liquid Propane Gas		Fuel Shut Off		Fuel Tank, Diesel
	Fuel Tank, LPG		Fuel Tank, Unleaded		Fuel, Unleaded

Symbol	Description	Symbol	Description	Symbol	Description
	Heat Exchanger		Holding Tank		Horn
	Hydraulic Oil		Hydraulic Oil Filter		Hydraulic Oil Level
	Hydraulic Oil Pressure		Hydraulic Oil Temperature		Hydraulic System
	Hydraulic System Malfunction		Interior Light		Lift Point
	Light		Lubricating Oil		Malfunction
	No Open Flame		Oil Tank		Outboard Drive
	Outboard Drive Tilt		Pressure		Propeller
	Propshaft Power		Propulsion System Trim		Propulsion System Trim, Bow Down
	Propulsion System Trim, Bow Up		Pump		Read Owner's Manual
	Seawater		Shift Only Fwd-N-Rev		Sling Location
	Tank		Throttle/Shift		Transmission
	Transmission Oil		Transmission Oil Filter		Transmission Oil Level
	Transmission Oil Malfunction		Transmission Oil Pressure		Transmission Oil Temperature
	Trim Tab Operation		Trim Tab Operation, Bow Down		Trim Tab Operation, Bow Up
	Volume Empty		Volume Full		Volume Half Full
	Warning		Warning Electrical Hazard		Warning Fire Risk
	Warning Hot		Waste Water, Sewage		Water Flushing Connector
	Windshield Washer Tank		Windshield Wiper & Washer		

LIMITED WARRANTY

Bayliner warrants to the original purchasers of its 1999 and 2000 model boats, purchased from an authorized dealer, operated under normal, noncommercial use that the selling dealer will: (A) Repair any structural hull defect which occurs within five (5) years of the date of delivery; and (B) Repair or replace any parts found to be defective in factory material or workmanship within one (1) year of the date of delivery.

What Is Not Covered

This limited warranty does not apply to:

1. Engines, drive trains, controls, props, batteries, or other equipment or accessories carrying their own individual warranties;
2. Engines, parts or accessories not installed by Bayliner;
3. Plexiglass windscreen breakage; rainwater leakage on runabout models; rainwater leakage through convertible tops; minor gelcoat discoloration, cracks or crazing or air voids;
4. Hull blisters that form below the waterline;
5. Normal deterioration, i.e. wear, tear, or corrosion of hardware, vinyl, tops, vinyl and fabric upholstery, plastic, metal, wood, or trim tape;
6. Any Bayliner boat used for commercial purposes;
7. Any defect caused by failure of the customer to provide reasonable care and maintenance.

Other Limitations

THERE ARE NO OTHER EXPRESS WARRANTIES ON THIS BOAT. TO THE EXTENT ALLOWED BY LAW:

1. ANY IMPLIED WARRANTY OF MERCHANTABILITY OR FITNESS FOR A PARTICULAR PURPOSE IS LIMITED TO THE DURATION OF ONE YEAR.
2. Neither Bayliner nor the selling dealer shall have any responsibility for loss of use of the boat, loss of time, inconvenience, commercial loss or consequential damages.
3. Some jurisdictions do not allow limitations on how long any implied warranty lasts, so the above limitation may not apply to you. Some jurisdictions do not allow the exclusion or limitation of incidental or consequential damages, so the above limitation or exclusion may not apply to you. This limited warranty gives you specific legal rights, and you may also have other rights which vary from state to state.

Your Obligation

In order to comply with regulations, it is essential that your limited warranty registration card be submitted within 30 days of delivery of your boat. Return of the limited warranty registration card is a condition precedent to limited warranty coverage. Before any warranty work is performed, we require that you contact your dealer to request warranty assistance.

YOU MUST GIVE US WRITTEN NOTICE OF YOUR WARRANTY CLAIM PRIOR TO THE EXPIRATION OF YOUR LIMITED WARRANTY AND ALLOW US AN OPPORTUNITY TO RESOLVE THE MATTER.

We require that you return your boat, at your expense, to your selling dealer or, if necessary, to the Bayliner factory. You will be responsible for all transportation, haulouts and other expenses incurred in returning the boat for warranty service.

Bayliner Marine Corporation

PO Box 9029
Everett, WA 98206

Phone: 360-435-8957
FAX: 360-403-4235

